

CATÁLOGO PRODUCTOS 2024



INOX 100%

Po. Ind. de Ponent, Ctra. Tèrmens, km 1.3 • 25142 Bellvís (Lleida) T. +34 973 197 485  
[www.ideacer.es](http://www.ideacer.es) • [comercial@ideacer.es](mailto:comercial@ideacer.es)



IDEACER  
INOX

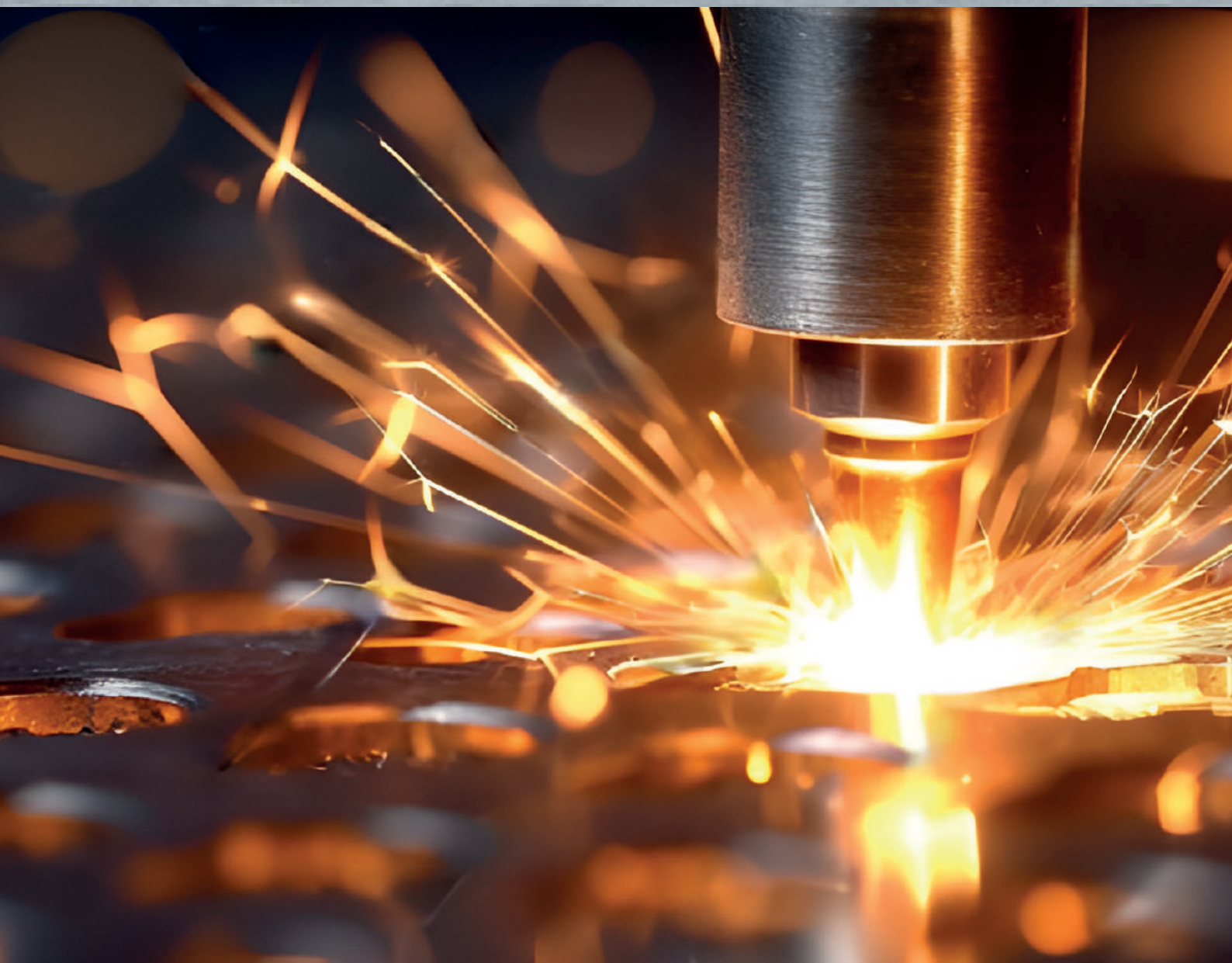

# Presentación

I D E A C E R  
INOX

En Ideacer, consideramos fundamental establecer relaciones duraderas y comprometidas con nuestros clientes, proveedores y empleados, con el objetivo de crear sinergias que impulsen el desarrollo de mejoras basadas en nuestras experiencias compartidas.

Con este **nuevo catálogo 2024**, pretendemos mantener nuestro liderazgo en el cambio de tendencia en el sector, que antepone por encima de los precios bajos, los productos de calidad, y así consolidarnos en el mercado como la empresa de referencia que ofrece la mejor combinación entre materiales de fabricación, diseño funcional y calidad de acabados.

Nos destacamos por nuestra constante innovación; aportando nuevas ideas, actualizando y perfeccionando nuestros productos para satisfacer las demandas cada vez más exigentes de un mercado en constante evolución y continuar siendo el **único fabricante** que les puede ofrecer artículos estándar, flexi estándar y medida, combinables entre ellos y **totalmente en acero inoxidable**.

Si no encuentran en este catálogo el producto estándar o flexi estándar que necesitan, o simplemente desean que sus productos reúnan unas características específicas que los diferencien del resto, les ofrecemos la opción de trabajos a medida. Nos adaptaremos a todas sus directrices y requisitos constructivos, además de brindar asesoramiento en el diseño, toma de medidas y construcción de los artículos a fabricar.







# Sostenibilidad & Medio ambiente

Todos los esfuerzos de Ideacer se orientan hacia iniciativas que contribuyan a una industria sostenible, aplicando las mejoras necesarias para reducir la huella de carbono en nuestra actividad y eligiendo proveedores y productos que cumplan con esas cualidades.

Para alcanzar estos objetivos hemos implementado una serie de acciones como la instalación de paneles solares fotovoltaicos de 70KW para autoconsumo, adquisición de maquinaria de última generación que ahorra un 60% de tiempo y consumo energético en comparación con las máquinas tradicionales, y la clasificación de todos los residuos generados para su posterior reutilización o reciclado.

En el caso de nuestros artículos fríos, empleamos gas R290, un refrigerante verde que se presenta como una alternativa más sostenible y respetuosa con el medio ambiente. No contiene agentes químicos que emitan gases de efecto invernadero en la atmósfera y minimiza el consumo de energía eléctrica.

Nuestro compromiso presente y futuro implica una revisión constante de nuestro consumo energético y el control riguroso de los procesos y materiales para contribuir de manera efectiva a la reducción de emisiones y contaminación.

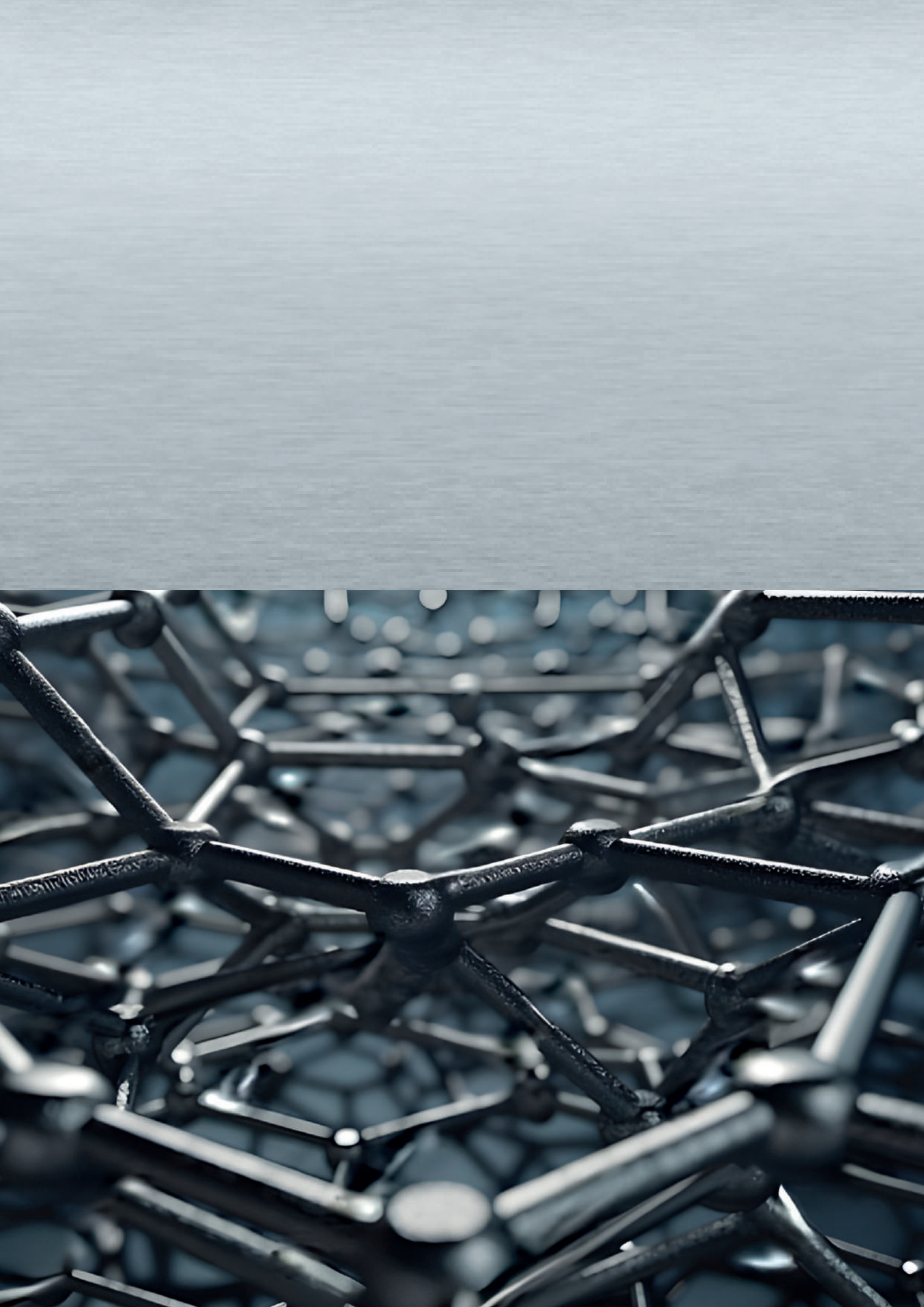

# Presentación del acero inoxidable AISI 304

I D E A C E R  
Inox

Los equipos de cocina deben garantizar niveles muy altos de higiene. El acero inoxidable AISI 304 es la opción idónea para equiparlas gracias a su inalterabilidad, resistencia a la corrosión/oxidación y óptima capacidad de limpieza y desinfección por su **elevado** grado de eliminación de bacterias.

Sin embargo, el contacto prolongado con elementos como cloruros (productos desinfectantes), agua de mar, partículas ferrosas, partículas abrasivas, grapas, latas, arena, etc. puede afectar la defensa natural del acero inoxidable, lo que posteriormente podría dar lugar a picaduras de "óxido" más o menos importantes.

#### **Precauciones de empleo:**

Para preservar sus propiedades de resistencia a la corrosión, el acero inoxidable requiere un mantenimiento regular. Es importante respetar los tiempos de contacto recomendados según el producto y realizar la limpieza regularmente con agua limpia o algún producto neutro para evitar posibles problemas de corrosión.

Sin este mantenimiento frecuente, los riesgos de corrosión pueden ser rápidos e irreversibles. Se debe evitar el uso de productos clorados (lejía) o ácido clorhídrico (sulfumán), incluso diluidos, debido a su alto poder corrosivo.





<b>01. GAMA ECO</b>	11
<b>02. LAVADO</b>	21
<b>03. SUMIDEROS</b>	43
<b>04. GRIFERÍA</b>	49
<b>05. CINTAS TRANSPORTADORAS</b>	59
<b>06. MESAS Y ACCESORIOS</b>	63
<b>07. ESTANTERÍAS</b>	89
<b>08. RECIPIENTES GN Y PASTELERÍA</b>	103
<b>09. MOBILIARIO NEUTRO</b>	109
<b>10. COCTELERÍA</b>	139
<b>11. CONSERVACIÓN Y DISTRIBUCIÓN</b>	149
<b>12. TRANSPORTE</b>	159
<b>13. AUTOSERVICIO</b>	167
<b>14. BUFFET</b>	185
<b>15. FLEXI ESTÁNDAR</b>	201





# 01.

- Fregaderos ECO y accesorios
- Mesas ECO
- Estanterías murales ECO
- Accesorios mesas ECO

# FREGADEROS ECO SOLDADOS

## H.850



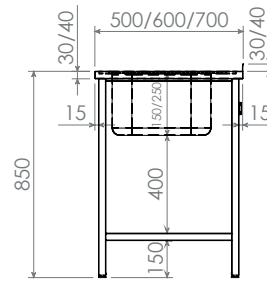







- **Frontal y peto** posterior de 30mm soldados en punto recto en fondo 500mm, y 40mm en fondos 600 y 700mm.
- **Válvula** con tapón incluidos.
- **Patas** de tubo 30x30mm con taco regulable hasta 30mm.



**Totalmente soldados**

### Fondo 500















DIM (mm)		CUBA	REF	PVP (€)	REF	PVP (€)	REF	PVP (€)
	500x500 1c	340x365x150	EC005005	<b>138</b>	EC055105	<b>322</b>	EC055205	<b>374</b>
	800x500 1c/1e dcha.	340x365x150	EC05008D	<b>150</b>	EC05108D	<b>334</b>	EC05208D	<b>391</b>
	800x500 1c/1e izq.	340x365x150	EC05008I	<b>150</b>	EC05108I	<b>334</b>	EC05208I	<b>391</b>
	900x500 1c/1e dcha.	340x365x150	EC05009D	<b>155</b>	EC05109D	<b>345</b>	EC05209D	<b>408</b>
	900x500 1c/1e izq.	340x365x150	EC05009I	<b>155</b>	EC05109I	<b>345</b>	EC05209I	<b>408</b>
	1000x500 1c/1e dcha.	340x365x150	EC05010D	<b>167</b>	EC05110D	<b>362</b>	EC05210D	<b>426</b>
	1000x500 1c/1e izq.	340x365x150	EC05010I	<b>167</b>	EC05110I	<b>362</b>	EC05210I	<b>426</b>
	1200x500 2c/1e dcha.	340x365x150	EC05012D	<b>224</b>	EC05112D	<b>426</b>	EC05212D	<b>541</b>
	1200x500 2c/1e izq.	340x365x150	EC05012I	<b>224</b>	EC05112I	<b>426</b>	EC05212I	<b>541</b>
	1350x500 2c/1e dcha.	340x365x150	EC05013D	<b>253</b>	EC05113D	<b>466</b>	EC05213D	<b>592</b>
	1350x500 2c/1e izq.	340x365x150	EC05013I	<b>253</b>	EC05113I	<b>466</b>	EC05213I	<b>592</b>

Espacio lavavasos hasta 470x500x720mm.



### Fondo 600

DIM (mm)		CUBA	REF	PVP (€)	REF	PVP (€)	REF	PVP (€)
	600x600 1c	400x400x250	EC060106	<b>253</b>	EC061606	<b>512</b>	EC067006	<b>621</b>
	1000x600 1c/1e dcha.	400x400x250	EC06010D	<b>299</b>	EC06610D	<b>587</b>	EC06710D	<b>725</b>
	1000x600 1c/1e izq.	400x400x250	EC06010I	<b>299</b>	EC06610I	<b>587</b>	EC06710I	<b>725</b>
	1200x600 1c/1e dcha.	400x400x250	EC06012D	<b>316</b>	EC06612D	<b>633</b>	EC06712D	<b>799</b>
	1200x600 1c/1e izq.	400x400x250	EC06012I	<b>316</b>	EC06612I	<b>633</b>	EC06712I	<b>799</b>
	1400x600 1c/1e dcha.	400x400x250	EC06014D	<b>339</b>	EC06614D	<b>690</b>	EC06714D	<b>857</b>
	1400x600 1c/1e izq.	400x400x250	EC06014I	<b>339</b>	EC06614I	<b>690</b>	EC06714I	<b>857</b>
	1400x600 2c/1e dcha.	400x400x250	EC06214D	<b>466</b>	EC06814D	<b>817</b>	EC06914D	<b>983</b>
	1400x600 2c/1e izq.	400x400x250	EC06214I	<b>466</b>	EC06814I	<b>817</b>	EC06914I	<b>983</b>
	1600x600 2c/1e dcha.	400x400x250	EC06216D	<b>483</b>	EC06816D	<b>874</b>	EC06916D	<b>1070</b>
	1600x600 2c/1e izq.	400x400x250	EC06216I	<b>483</b>	EC06816I	<b>874</b>	EC06916I	<b>1070</b>
	1800x600 2c/1e dcha.	400x400x250	EC06218D	<b>500</b>	EC06818D	<b>932</b>	EC06918D	<b>1144</b>
	1800x600 2c/1e izq.	400x400x250	EC06218I	<b>500</b>	EC06818I	<b>932</b>	EC06918I	<b>1144</b>

Espacio lavavasos o lavavajillas hasta 600x600x820mm.

## Fondo 700



DIM (mm)	CUBA	REF	PVP (€)	REF	PVP (€)	REF	PVP (€)
700x700 1c	500x500x250	EC070007	<b>276</b>	EC071606	<b>546</b>	EC077006	<b>650</b>
1000x700 1c/1e dcha.	400x500x250	EC07010D	<b>322</b>	EC07610D	<b>615</b>	EC07710D	<b>753</b>
1000x700 1c/1e izq.	400x500x250	EC07010I	<b>322</b>	EC07610I	<b>615</b>	EC07710I	<b>753</b>
1200x700 1c/1e dcha.	400x500x250	EC07012D	<b>339</b>	EC07612D	<b>667</b>	EC07712D	<b>828</b>
1200x700 1c/1e izq.	400x500x250	EC07012I	<b>339</b>	EC07612I	<b>667</b>	EC07712I	<b>828</b>
1400x700 1c/1e dcha.	400x500x250	EC07014D	<b>357</b>	EC07614D	<b>725</b>	EC07714D	<b>903</b>
1400x700 1c/1e izq.	400x500x250	EC07014I	<b>357</b>	EC07614I	<b>725</b>	EC07714I	<b>903</b>
1400x700 2c/1e dcha.	400x500x250	EC07214D	<b>477</b>	EC07814D	<b>851</b>	EC07914D	<b>1081</b>
1400x700 2c/1e izq.	400x500x250	EC07214I	<b>477</b>	EC07814I	<b>851</b>	EC07914I	<b>1081</b>
1600x700 2c/1e dcha.	400x500x250	EC07216D	<b>512</b>	EC07816D	<b>920</b>	EC07916D	<b>1133</b>
1600x700 2c/1e izq.	400x500x250	EC07216I	<b>512</b>	EC07816I	<b>920</b>	EC07916I	<b>1133</b>
1800x700 2c/1e dcha.	400x500x250	EC07218D	<b>541</b>	EC07818D	<b>995</b>	EC07918D	<b>1219</b>
1800x700 2c/1e izq.	400x500x250	EC07218I	<b>541</b>	EC07818I	<b>995</b>	EC07918I	<b>1219</b>

Espacio lavavasos o lavavajillas hasta 600x600x820mm.

## CARTELAS PARA FREGADEROS ECO

- Preparadas para soportar los fregaderos.
- Fabricadas en chapa de 1,5mm.

Incluyen tacos y tornillos para su instalación.



CARACTERÍSTICAS	REF	PVP (€)
Cartela de sujeción derecha para fregadero fondo 500mm	IDH04585D	<b>46</b>
Cartela de sujeción izquierda para fregadero fondo 500mm	IDH04585I	<b>46</b>
Cartela de sujeción derecha para fregadero fondo 600mm	IDH04586D	<b>52</b>
Cartela de sujeción izquierda para fregadero fondo 600mm	IDH04586I	<b>52</b>
Cartela de sujeción derecha para fregadero fondo 700mm	IDH04587D	<b>58</b>
Cartela de sujeción izquierda para fregadero fondo 700mm	IDH04587I	<b>58</b>

## DELANTAL FREGADEROS ECO



Totalmente soldados

CARACTERÍSTICAS	REF	PVP (€)
Delantal 1 cuba dcha.	ECO99001D	<b>86</b>
Delantal 1 cuba izq.	ECO99001I	<b>86</b>
Delantal 2 cubas dcha.	ECO99002D	<b>132</b>
Delantal 2 cubas izq.	ECO99002I	<b>132</b>





## MESAS CENTRALES ECO SOLDADAS H.850

- **Frontal** de 30mm en mesas de 500mm y de 40mm en mesas de 600 y 700mm.
- **Patas** de tubo 30x30 con taco regulable.



Totalmente soldadas

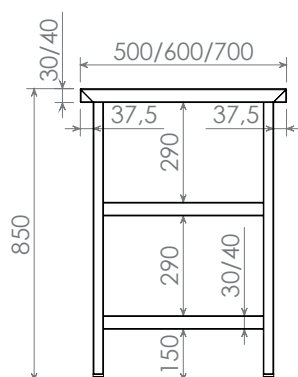

### Fondo 500



DIM (mm)	MARCO REF.	PVP (€)	1 ESTANTE	PVP (€)	2 ESTANTES	PVP (€)
600x500	EC005006	391	EC005106	449	EC005206	546
800x500	EC005008	403	EC005108	472	EC005208	575
1000x500	EC005010	420	EC005110	500	EC005210	621
1200x500	EC005012	437	EC005112	529	EC005212	667
1400x500	EC005014	454	EC005114	564	EC005214	713
1500x500	EC005015	466	EC005115	581	EC005215	736
1600x500	EC005016	489	EC005116	598	EC005216	759
1800x500	EC005018	512	EC005118	627	EC005218	799
2000x500	EC005020	535	EC005120	656	EC005220	845

### Fondo 600



DIM (mm)	MARCO REF.	PVP (€)	1 ESTANTE	PVP (€)	2 ESTANTES	PVP (€)
600x600	EC006006	<b>408</b>	EC006106	<b>466</b>	EC006206	<b>564</b>
800x600	EC006008	<b>431</b>	EC006108	<b>495</b>	EC006208	<b>604</b>
1000x600	EC006010	<b>454</b>	EC006110	<b>529</b>	EC006210	<b>650</b>
1200x600	EC006012	<b>472</b>	EC006112	<b>558</b>	EC006212	<b>696</b>
1400x600	EC006014	<b>495</b>	EC006114	<b>592</b>	EC006214	<b>742</b>
1500x600	EC006015	<b>506</b>	EC006115	<b>610</b>	EC006215	<b>771</b>
1600x600	EC006016	<b>518</b>	EC006116	<b>621</b>	EC006216	<b>794</b>
1800x600	EC006018	<b>535</b>	EC006118	<b>656</b>	EC006218	<b>834</b>
2000x600	EC006020	<b>558</b>	EC006120	<b>684</b>	EC006220	<b>880</b>

### Fondo 700



DIM (mm)	MARCO REF.	PVP (€)	1 ESTANTE	PVP (€)	2 ESTANTES	PVP (€)
600x700	EC007006	<b>414</b>	EC007106	<b>472</b>	EC007206	<b>575</b>
800x700	EC007008	<b>437</b>	EC007108	<b>506</b>	EC007208	<b>627</b>
1000x700	EC007010	<b>460</b>	EC007110	<b>546</b>	EC007210	<b>673</b>
1200x700	EC007012	<b>483</b>	EC007112	<b>581</b>	EC007212	<b>725</b>
1400x700	EC007014	<b>506</b>	EC007114	<b>615</b>	EC007214	<b>776</b>
1500x700	EC007015	<b>518</b>	EC007115	<b>633</b>	EC007215	<b>799</b>
1600x700	EC007016	<b>529</b>	EC007116	<b>650</b>	EC007216	<b>828</b>
1800x700	EC007018	<b>552</b>	EC007118	<b>684</b>	EC007218	<b>880</b>
2000x700	EC007020	<b>575</b>	EC007120	<b>719</b>	EC007220	<b>932</b>

## MESAS MURALES ECO SOLDADAS

### H.850

- **Frontal y peto** trasero en punto recto de 30mm en mesas de 500mm y de 40mm en mesas de 600 y 700mm.
- **Patas** de tubo 30x30mm con taco regulable hasta 30mm.



Totalmente soldadas

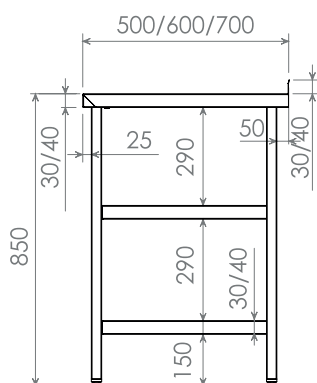

### Fondo 500



DIM (mm)	MARCO REF.	PVP (€)	1 ESTANTE	PVP (€)	2 ESTANTES	PVP (€)
600x500	EC050006	403	EC051006	460	EC052006	558
800x500	EC050008	414	EC051008	483	EC052008	587
1000x500	EC050010	431	EC051010	512	EC052010	633
1200x500	EC050012	449	EC051012	541	EC052012	679
1400x500	EC050014	466	EC051014	575	EC052014	725
1500x500	EC050015	477	EC051015	592	EC052015	748
1600x500	EC050016	500	EC051016	610	EC052016	771
1800x500	EC050018	523	EC051018	638	EC052018	811
2000x500	EC050020	546	EC051020	667	EC052020	857



### Fondo 600



DIM (mm)	MARCO REF.	PVP (€)	1 ESTANTE	PVP (€)	2 ESTANTES	PVP (€)
600x600	EC060006	<b>420</b>	EC061006	<b>472</b>	EC062006	<b>575</b>
800x600	EC060008	<b>437</b>	EC061008	<b>500</b>	EC062008	<b>615</b>
1000x600	EC060010	<b>454</b>	EC061010	<b>535</b>	EC062010	<b>667</b>
1200x600	EC060012	<b>477</b>	EC061012	<b>569</b>	EC062012	<b>719</b>
1400x600	EC060014	<b>500</b>	EC061014	<b>604</b>	EC062014	<b>765</b>
1500x600	EC060015	<b>512</b>	EC061015	<b>621</b>	EC062015	<b>771</b>
1600x600	EC060016	<b>523</b>	EC061016	<b>638</b>	EC062016	<b>817</b>
1800x600	EC060018	<b>546</b>	EC061018	<b>673</b>	EC062018	<b>863</b>
2000x600	EC060020	<b>569</b>	EC061020	<b>707</b>	EC062020	<b>914</b>

### Fondo 700



DIM (mm)	MARCO REF.	PVP (€)	1 ESTANTE	PVP (€)	2 ESTANTES	PVP (€)
600x700	EC070006	<b>426</b>	EC071006	<b>477</b>	EC072006	<b>587</b>
800x700	EC070008	<b>443</b>	EC071008	<b>518</b>	EC072008	<b>644</b>
1000x700	EC070010	<b>472</b>	EC071010	<b>558</b>	EC072010	<b>702</b>
1200x700	EC070012	<b>495</b>	EC071012	<b>592</b>	EC072012	<b>753</b>
1400x700	EC070014	<b>518</b>	EC071014	<b>633</b>	EC072014	<b>811</b>
1500x700	EC070015	<b>529</b>	EC071015	<b>650</b>	EC072015	<b>834</b>
1600x700	EC070016	<b>541</b>	EC071016	<b>673</b>	EC072016	<b>868</b>
1800x700	EC070018	<b>569</b>	EC071018	<b>707</b>	EC072018	<b>920</b>
2000x700	EC070020	<b>592</b>	EC071020	<b>748</b>	EC072020	<b>978</b>

# MESAS ECO SOLDADAS

## H.600

01.

- **Frontal** de 30mm en mesas de 500mm y de 40mm en mesas de 600 y 700mm.
- **Patas** de tubo 30x30 con taco regulable.



**Totalmente soldadas**

### CENTRALES



### MURALES

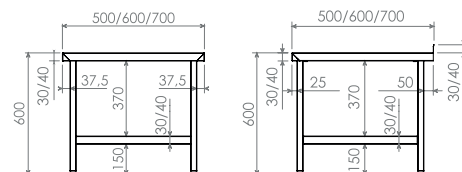

#### FONDO 500

DIM (mm)	MARCO REF.	PVP (€)	1 ESTANTE	PVP (€)
600	EC055006	<b>385</b>	EC055106	<b>443</b>
800	EC055008	<b>397</b>	EC055108	<b>466</b>
1000	EC055010	<b>414</b>	EC055110	<b>495</b>
1200	EC055012	<b>431</b>	EC055112	<b>523</b>
1400	EC055014	<b>449</b>	EC055114	<b>558</b>
1500	EC055015	<b>460</b>	EC055115	<b>575</b>
1600	EC055016	<b>483</b>	EC055116	<b>592</b>
1800	EC055018	<b>506</b>	EC055118	<b>621</b>
2000	EC055020	<b>529</b>	EC055120	<b>650</b>

MARCO REF.	PVP (€)	1 ESTANTE	PVP (€)
EC056006	<b>397</b>	EC056106	<b>454</b>
EC056008	<b>408</b>	EC056108	<b>477</b>
EC056010	<b>426</b>	EC056110	<b>506</b>
EC056012	<b>443</b>	EC056112	<b>535</b>
EC056014	<b>460</b>	EC056114	<b>569</b>
EC056015	<b>472</b>	EC056115	<b>587</b>
EC056016	<b>495</b>	EC056116	<b>604</b>
EC056018	<b>518</b>	EC056118	<b>633</b>
EC056020	<b>541</b>	EC056120	<b>661</b>

#### FONDO 600

DIM (mm)	MARCO REF.	PVP (€)	1 ESTANTE	PVP (€)
600	EC065006	<b>403</b>	EC065106	<b>460</b>
800	EC065008	<b>426</b>	EC065108	<b>489</b>
1000	EC065010	<b>437</b>	EC065110	<b>523</b>
1200	EC065012	<b>466</b>	EC065112	<b>552</b>
1400	EC065014	<b>489</b>	EC065114	<b>587</b>
1500	EC065015	<b>500</b>	EC065115	<b>604</b>
1600	EC065016	<b>512</b>	EC065116	<b>615</b>
1800	EC065018	<b>529</b>	EC065118	<b>650</b>
2000	EC065020	<b>552</b>	EC065120	<b>679</b>

MARCO REF.	PVP (€)	1 ESTANTE	PVP (€)
EC066006	<b>414</b>	EC066106	<b>466</b>
EC066008	<b>431</b>	EC066108	<b>495</b>
EC066010	<b>449</b>	EC066110	<b>529</b>
EC066012	<b>472</b>	EC066112	<b>564</b>
EC066014	<b>495</b>	EC066114	<b>598</b>
EC066015	<b>506</b>	EC066115	<b>615</b>
EC066016	<b>518</b>	EC066116	<b>633</b>
EC066018	<b>541</b>	EC066118	<b>667</b>
EC066020	<b>564</b>	EC066120	<b>702</b>

#### FONDO 700

DIM (mm)	MARCO REF.	PVP (€)	1 ESTANTE	PVP (€)
600	EC075006	<b>408</b>	EC075106	<b>466</b>
800	EC075008	<b>431</b>	EC075108	<b>500</b>
1000	EC075010	<b>454</b>	EC075110	<b>541</b>
1200	EC075012	<b>477</b>	EC075112	<b>575</b>
1400	EC075014	<b>489</b>	EC075114	<b>610</b>
1500	EC075015	<b>512</b>	EC075115	<b>627</b>
1600	EC075016	<b>523</b>	EC075116	<b>644</b>
1800	EC075018	<b>546</b>	EC075118	<b>679</b>
2000	EC075020	<b>569</b>	EC075120	<b>713</b>

MARCO REF.	PVP (€)	1 ESTANTE	PVP (€)
EC076006	<b>420</b>	EC076106	<b>472</b>
EC076008	<b>437</b>	EC076108	<b>512</b>
EC076010	<b>466</b>	EC076110	<b>552</b>
EC076012	<b>489</b>	EC076112	<b>587</b>
EC076014	<b>512</b>	EC076114	<b>627</b>
EC076015	<b>523</b>	EC076115	<b>644</b>
EC076016	<b>535</b>	EC076116	<b>667</b>
EC076018	<b>564</b>	EC076118	<b>702</b>
EC076020	<b>587</b>	EC076120	<b>742</b>



**Se suministran desmontadas**  
Rápido y fácil montaje

**Dotación de tacos y tornillos para su instalación.**

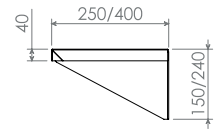

### LISAS



### PERFORADAS



#### FONDO 250

#### FONDO 400

#### FONDO 250

#### FONDO 400

DIM (mm)	REF	PVP (€)	REF	PVP (€)
600	EC000625	<b>92</b>	EC000640	<b>104</b>
800	EC000825	<b>104</b>	EC000840	<b>121</b>
1000	EC001025	<b>115</b>	EC001040	<b>132</b>
1200	EC001225	<b>127</b>	EC001240	<b>150</b>
1400	EC001425	<b>138</b>	EC001440	<b>167</b>
1500	EC001525	<b>144</b>	EC001540	<b>178</b>
1600	EC001625	<b>155</b>	EC001640	<b>190</b>
1800	EC001825	<b>173</b>	EC001840	<b>207</b>
2000	EC002025	<b>190</b>	EC002040	<b>230</b>

REF	PVP (€)	REF	PVP (€)
EC010625	<b>121</b>	EC010640	<b>138</b>
EC010825	<b>132</b>	EC010840	<b>150</b>
EC011025	<b>144</b>	EC011040	<b>167</b>
EC011225	<b>155</b>	EC011240	<b>190</b>
EC011425	<b>167</b>	EC011440	<b>207</b>
EC011525	<b>184</b>	EC011540	<b>224</b>
EC011625	<b>201</b>	EC011640	<b>242</b>
EC011825	<b>219</b>	EC011840	<b>259</b>
EC012025	<b>242</b>	EC012040	<b>276</b>

## ACCESORIOS MESAS ECO

**Especificar en caso necesario la ubicación del elemento elegido.**

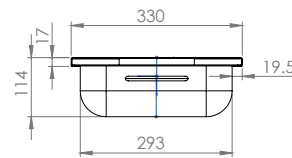
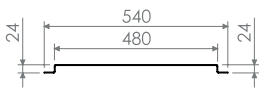

### Cuchillero ECO

CARACTERÍSTICAS	REF	PVP (€)
Cuchillero 500x40x20mm	EC099420	<b>52</b>

### Cajón ECO

CARACTERÍSTICAS	REF	PVP (€)
Cajón simple 330x360x110mm mesa ECO	EC099140	<b>167</b>



**Totalmente montadas**  
Se suministran montadas a la mesa elegida.

### Adaptación de ruedas



CARACTERÍSTICAS	REF	PVP (€)
4 RUEDAS ø100mm sintéticas (2 con freno)	EC099401	<b>247</b>
4 RUEDAS ø100mm inoxidable (2 con freno)	EC099402	<b>293</b>

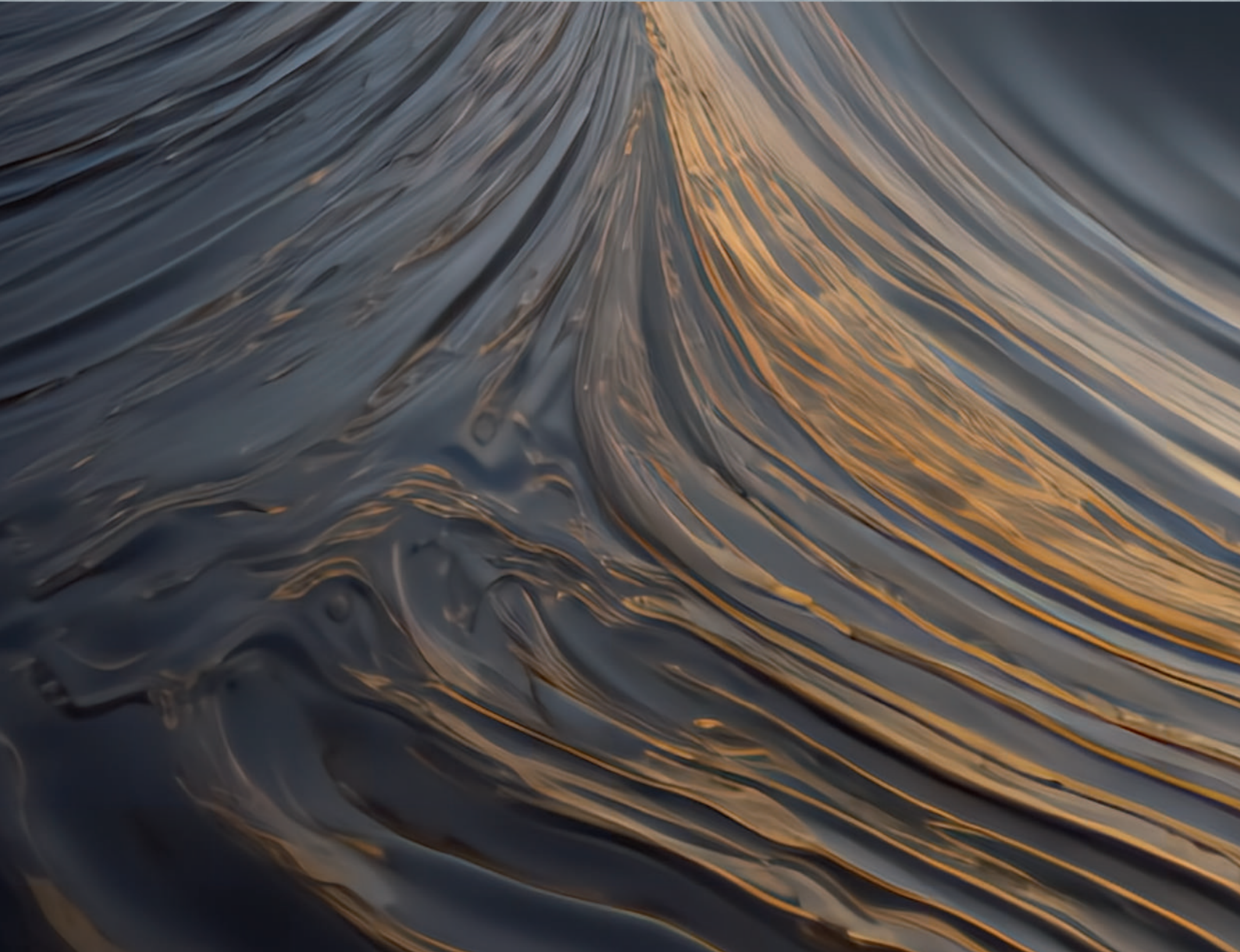



# 02.

- Fregaderos
- Fregaderos con bastidor soldado
- Bastidores desmontados
- Módulos bastidores soldados con puertas
- Accesorios
- Fregadero vertedero
- Puanas lavavajillas
- Cuerpos de guías
- Mesas lavavajillas
- Encimera salida
- Estanterías
- Accesorios
- Lavamanos y accesorios
- Cañón de ozono
- Dispensador de gel



## FREGADEROS

### Fondo 600

- **Frontal** soldado de 60mm en punto redondo, **peto** posterior soldado de 100mm con radio sanitario.
- **Incluye** válvula desagüe y tubo rebosadero.

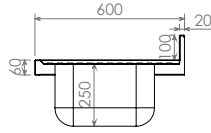

## FREGADEROS CON BASTIDOR SOLDADO H.850





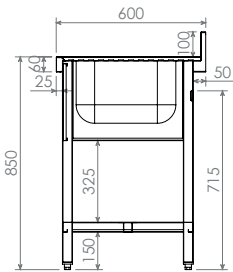

### Fondo 600

- **Estante** inferior opcional reforzado con omega central.
- **Espacio lavavajillas** 600x600x840mm estándar.
- **Patas** de tubo 40x40mm con taco regulable hasta 60mm.



Totalmente soldados

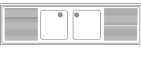

DIM (mm)		CUBA	REF	PVP	REF	PVP	REF	PVP	REF	PVP	REF	PVP	
	600	1c	400x400x250	IDL60006	<b>316</b>	IDL06060	<b>569</b>	IDL06160	<b>673</b>				
	700	1c	500x400x250	IDL60007	<b>362</b>	IDL07060	<b>638</b>	IDL07160	<b>753</b>				
	800	1c	500x400x250	IDL60008	<b>414</b>	IDL08060	<b>667</b>	IDL08160	<b>782</b>				
	1200	2c	500x400x250	IDL60012	<b>541</b>	IDL12060	<b>914</b>	IDL12160	<b>1035</b>				
	1400	2c	500x400x250	IDL60014	<b>736</b>	IDL14060	<b>1047</b>	IDL14160	<b>1231</b>				
	1000	1c/1e D	400x400x250	IDL6010D	<b>368</b>	IDL1006D	<b>679</b>	IDL1016D	<b>794</b>				
	1000	1c/1e I	400x400x250	IDL6010I	<b>368</b>	IDL1006I	<b>679</b>	IDL1016I	<b>794</b>				
	1100	1c/1e D	400x400x250	IDL6011D	<b>414</b>	IDL1106D	<b>690</b>	IDL1116D	<b>840</b>	IDL1156D	<b>656</b>	IDL1166D	<b>782</b>
	1100	1c/1e I	400x400x250	IDL6011I	<b>414</b>	IDL1106I	<b>690</b>	IDL1116I	<b>840</b>	IDL1156I	<b>656</b>	IDL1166I	<b>782</b>
	1200	1c/1e D	400x400x250	IDL6012D	<b>339</b>	IDL1206D	<b>644</b>	IDL1216D	<b>799</b>	IDL1256D	<b>615</b>	IDL1266D	<b>736</b>
	1200	1c/1e I	400x400x250	IDL6012I	<b>339</b>	IDL1206I	<b>644</b>	IDL1216I	<b>799</b>	IDL1256I	<b>615</b>	IDL1266I	<b>736</b>
	1400	1c/1e D	500x400x250	IDL6014D	<b>437</b>	IDL1406D	<b>863</b>	IDL1416D	<b>1047</b>	IDL1456D	<b>811</b>	IDL1466D	<b>960</b>
	1400	1c/1e I	500x400x250	IDL6014I	<b>437</b>	IDL1406I	<b>863</b>	IDL1416I	<b>1047</b>	IDL1456I	<b>811</b>	IDL1466I	<b>960</b>
	1400	2c/1e D	400x400x250	IDL6214D	<b>541</b>	IDL1426D	<b>955</b>	IDL1436D	<b>1144</b>				
	1400	2c/1e I	400x400x250	IDL6214I	<b>541</b>	IDL1426I	<b>955</b>	IDL1436I	<b>1144</b>				
	1600	2c/1e D	400x400x250	IDL6216D	<b>587</b>	IDL1606D	<b>983</b>	IDL1616D	<b>1196</b>	IDL1656D	<b>920</b>	IDL1666D	<b>1075</b>
	1600	2c/1e I	400x400x250	IDL6216I	<b>587</b>	IDL1606I	<b>983</b>	IDL1616I	<b>1196</b>	IDL1656I	<b>920</b>	IDL1666I	<b>1075</b>
	1800	2c/1e D	500x400x250	IDL6218D	<b>638</b>	IDL1806D	<b>1047</b>	IDL1816D	<b>1294</b>	IDL1856D	<b>983</b>	IDL1866D	<b>1150</b>
	1800	2c/1e I	500x400x250	IDL6218I	<b>638</b>	IDL1806I	<b>1047</b>	IDL1816I	<b>1294</b>	IDL1856I	<b>983</b>	IDL1866I	<b>1150</b>
	2100	2c/2e	500x400x250	IDL6222I	<b>725</b>	IDL21060	<b>1185</b>	IDL21160	<b>1455</b>				

Espacio lavavasos o lavavajillas

PVP en €

# 02.



## BASTIDORES DESMONTADOS Y MÓDULOS BASTIDORES SOLDADOS CON PUERTAS H.850

Fondo 600

- **Trasera** abierta para facilitar conexiones.
- Espacio **lavavajillas** 600x600x840mm estándar.

### Bastidores:

- **Estante** inferior opcional reforzado con omega central.
- **Patas** de tubo 40x40mm con taco regulable hasta 60mm.

### Módulos con puertas:

- **Estante** base con doble omega de refuerzo.
- **Puertas correderas** con rodamiento superior de nylon.
- **Puertas batientes** con bisagra vertical pivotante.
- **Patas** cilíndricas de acero inoxidable 150mm regulables hasta 50mm.

Especificar apertura puerta hacia derecha (D) o izquierda (I).



#### Montaje rápido y fácil

Se suministran desmontados.  
Montaje fácil y rápido mediante tornillería.



#### Totalmente soldados

Se suministran totalmente montados y soldados al fregadero elegido.



DIM (mm)	BASTIDOR	PVP	ESTANTE	PVP
600	IDL0660D	207	IDL0660E	104
700	IDL0760D	219	IDL0760E	109
800	IDL0860D	230	IDL0860E	115
1000	IDL1060D	242	IDL1060E	138
1100	IDL1160D	247	IDL1160E	150
1100	IDL1165D	230	IDL1165E	127
1200	IDL1260D	253	IDL1260E	155
1200	IDL1265D	224	IDL1265E	121
1400	IDL1460D	288	IDL1460E	184
1400	IDL1465D	236	IDL1465E	150
1600	IDL1660D	311	IDL1660E	213
1600	IDL1665D	247	IDL1665E	155
1800	IDL1860D	334	IDL1860E	247
1800	IDL1865D	270	IDL1865E	167
2100	IDL2160D	368	IDL2160E	270

Espacio lavavasos o lavavajillas

P. COR.	PVP	P. BAT.	PVP
		IDL40660 D/I	1P 592
		IDL40760 D/I	1P 644
		IDL40860	2P 725
IDL46010	736	IDL41060	2P 799
IDL46011	759	IDL41160	2P 817
		IDL41165 D/I	1P 661
IDL46012	794	IDL41260	2P 840
		IDL41265 D/I	1P 650
IDL46014	828		
		IDL41465	2P 817
IDL46016	874		
IDL46165	955		
IDL46018	909		
IDL46185	978		
IDL46021	989		

PVP en €

## FREGADEROS

### Fondo 700

- **Frontal** soldado de 60mm en punto redondo, **peto** posterior soldado de 100mm con radio sanitario.
- **Incluye** válvula desagüe y tubo rebosadero.

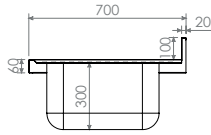

## FREGADEROS CON BASTIDOR SOLDADO H.850

### Fondo 700

- **Estante** inferior opcional reforzado con omega central.
- **Espacio lavavajillas** 600x600x840mm estándar.
- **Patas** de tubo 40x40mm con taco regulable hasta 60mm.

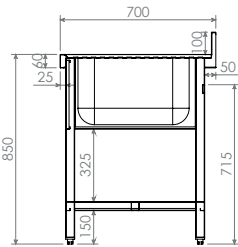

Totalmente soldados



DIM (mm)		CUBA	REF	PVP	REF	PVP	REF	PVP	REF	PVP	REF	PVP	
	600	1c	500x500x300	IDL70006	<b>368</b>	IDL06070	<b>656</b>	IDL06170	<b>765</b>				
	700	1c	500x500x300	IDL70007	<b>374</b>	IDL07070	<b>684</b>	IDL07170	<b>799</b>				
	800	1c	500x500x300	IDL70008	<b>385</b>	IDL08070	<b>794</b>	IDL08170	<b>920</b>				
	1200	2c	500x500x300	IDL70012	<b>598</b>	IDL12070	<b>1029</b>	IDL12170	<b>1213</b>				
	1400	2c	500x500x300	IDL70014	<b>673</b>	IDL14070	<b>1242</b>	IDL14170	<b>1449</b>				
	1000	1c/1e D	400x500x300	IDL7010D	<b>391</b>	IDL1007D	<b>771</b>	IDL1017D	<b>926</b>				
	1000	1c/1e I	400x500x300	IDL7010I	<b>391</b>	IDL1007I	<b>771</b>	IDL1017I	<b>926</b>				
	1100	1c/1e D	400x500x300	IDL7011D	<b>495</b>	IDL1107D	<b>799</b>	IDL1117D	<b>960</b>	IDL1157D	<b>748</b>	IDL1197D	<b>874</b>
	1100	1c/1e I	400x500x300	IDL7011I	<b>495</b>	IDL1107I	<b>799</b>	IDL1117I	<b>960</b>	IDL1157I	<b>748</b>	IDL1197I	<b>874</b>
	1200	1c/1e D	400x500x300	IDL7012D	<b>385</b>	IDL1207D	<b>730</b>	IDL1217D	<b>914</b>	IDL1257D	<b>684</b>	IDL1297D	<b>817</b>
	1200	1c/1e I	400x500x300	IDL7012I	<b>385</b>	IDL1207I	<b>730</b>	IDL1217I	<b>914</b>	IDL1257I	<b>684</b>	IDL1297I	<b>817</b>
	1400	1c/1e D	500x500x300	IDL7014D	<b>460</b>	IDL1407D	<b>914</b>	IDL1417D	<b>1121</b>	IDL1457D	<b>868</b>	IDL1497D	<b>1024</b>
	1400	1c/1e I	500x500x300	IDL7014I	<b>460</b>	IDL1407I	<b>914</b>	IDL1417I	<b>1121</b>	IDL1457I	<b>868</b>	IDL1497I	<b>1024</b>
	1400	2c/1e D	400x500x300	IDL7214D	<b>604</b>	IDL1427D	<b>1070</b>	IDL1437D	<b>1277</b>				
	1400	2c/1e I	400x500x300	IDL7214I	<b>604</b>	IDL1427I	<b>1070</b>	IDL1437I	<b>1277</b>				
	1600	2c/1e D	400x500x300	IDL7216D	<b>627</b>	IDL1607D	<b>1127</b>	IDL1617D	<b>1369</b>	IDL1657D	<b>1052</b>	IDL1697D	<b>1219</b>
	1600	2c/1e I	400x500x300	IDL7216I	<b>627</b>	IDL1607I	<b>1127</b>	IDL1617I	<b>1369</b>	IDL1657I	<b>1052</b>	IDL1697I	<b>1219</b>
	1800	2c/1e D	500x500x300	IDL7218D	<b>707</b>	IDL1807D	<b>1294</b>	IDL1817D	<b>1443</b>	IDL1857D	<b>1104</b>	IDL1897D	<b>1288</b>
	1800	2c/1e I	500x500x300	IDL7218I	<b>707</b>	IDL1807I	<b>1294</b>	IDL1817I	<b>1443</b>	IDL1857I	<b>1104</b>	IDL1897I	<b>1288</b>
	2100	2c/2e	500x500x300	IDL7222I	<b>874</b>	IDL21070	<b>1403</b>	IDL21170	<b>1696</b>				

Espacio lavavasos o lavavajillas

PVP en €

# 02.



## BASTIDORES DESMONTADOS Y MÓDULOS BASTIDORES SOLDADOS CON PUERTAS H.850

Fondo 700

- **Trasera** abierta para facilitar conexiones.
- Espacio **lavavajillas** 600x600x840mm estándar.

### Bastidores:

- **Estante** inferior opcional reforzado con omega central.
- **Patas** de tubo 40x40mm con taco regulable hasta 60mm.

### Módulos con puertas:

- **Estante** base con doble omega de refuerzo.
- **Puertas correderas** con rodamiento superior de nylon.
- **Puertas batientes** con bisagra vertical pivotante.
- **Patas** cilíndricas de acero inoxidable 150mm regulables hasta 50mm.

Especificar apertura puerta hacia derecha (D) o izquierda (I).



#### Montaje rápido y fácil

Se suministran desmontados.  
Montaje fácil y rápido mediante tornillería.



#### Totalmente soldados

Se suministran totalmente montados y soldados al fregadero elegido.



DIM (mm)	BASTIDOR	PVP	ESTANTE	PVP
600	IDL0670D	219	IDL0670E	109
700	IDL0770D	230	IDL0770E	115
800	IDL0870D	253	IDL0870E	127
1000	IDL1070D	265	IDL1070E	155
1100	IDL1170D	276	IDL1170E	167
1100	IDL1175D	242	IDL1175E	138
1200	IDL1270D	282	IDL1270E	184
1200	IDL1175D	230	IDL1275E	132
1400	IDL1470D	299	IDL1470E	207
1400	IDL1475D	253	IDL1475E	155
1600	IDL1670D	339	IDL1670E	242
1600	IDL1675D	265	IDL1675E	167
1800	IDL1870D	357	IDL1870E	265
1800	IDL1875D	282	IDL1875E	184
2100	IDL2170D	385	IDL2170E	293

Espacio lavavasos o lavavajillas

P. COR.	PVP	P. BAT.	PVP
		IDL40670 D/I	1P 719
		IDL40770 D/I	1P 759
		IDL40870	2P 805
IDL47010	759	IDL41070	2P 886
IDL47011	782	IDL41170	2P 897
		IDL41175 D/I	1P 702
IDL47012	817	IDL41270	2P 937
		IDL41275 D/I	1P 690
IDL47014	840		
		IDL41475	2P 909
IDL47016	909		
IDL47165	966		
IDL47018	943		
IDL47185	1012		
IDL47021	1024		

PVP en €

## FREGADEROS

### Fondo 700 Gran capacidad

- **Frontal** soldado de 60mm en punto redondo, **peto** posterior soldado de 100mm con radio sanitario.
- **Incluye** válvula desagüe y tubo rebosadero.

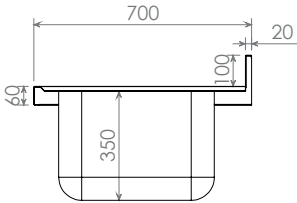

## FREGADEROS CON BASTIDOR SOLDADO H.850





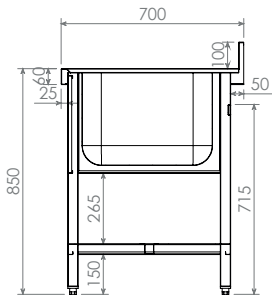





### Fondo 700 gran capacidad

- **Estante** inferior opcional reforzado con omega central.
- **Patas** de tubo 40x40mm con taco regulable hasta 60mm.



**Totalmente soldados**



DIM (mm)		CUBA	REF	PVP	REF	PVP	REF	PVP	
	1000	1c	800x500x350	IDL77110	<b>713</b>	IDL10370	<b>1006</b>	IDL10470	<b>1162</b>
	1200	1c	1100x500x350	IDL77112	<b>834</b>	IDL12370	<b>1139</b>	IDL12470	<b>1323</b>
	1400	1c	1200x500x350	IDL77114	<b>886</b>	IDL14370	<b>1208</b>	IDL14470	<b>1415</b>
	1800	2c	800x500x350	IDL77218	<b>1081</b>	IDL18370	<b>1518</b>	IDL18470	<b>1783</b>
	1600	1c/1e D	950x500x350	IDL77116D	<b>874</b>	IDL1637D	<b>1288</b>	IDL1647D	<b>1530</b>
	1600	1c/1e I	950x500x350	IDL77116I	<b>874</b>	IDL1637I	<b>1288</b>	IDL1647I	<b>1530</b>
	2000	1c/1e D	1200x500x350	IDL77120D	<b>1070</b>	IDL2037D	<b>1438</b>	IDL2047D	<b>1725</b>
	2000	1c/1e I	1200x500x350	IDL77120I	<b>1070</b>	IDL2037I	<b>1438</b>	IDL2047I	<b>1725</b>
	2000	2c/1e D	600x500x350	IDL77220D	<b>1144</b>	IDL2237D	<b>1547</b>	IDL2247D	<b>1834</b>
	2000	2c/1e I	600x500x350	IDL77220I	<b>1144</b>	IDL2237I	<b>1547</b>	IDL2247I	<b>1834</b>
	1800	3 cubas	500x500x350	IDL77318	<b>897</b>	IDL18570	<b>1334</b>	IDL18670	<b>1599</b>

PVP en €





## BASTIDORES DESMONTADOS Y MÓDULOS BASTIDORES SOLDADOS CON PUERTAS H.850

Fondo 700 / Gran Capacidad

- **Trasera** abierta para facilitar conexiones.

### Bastidores:

- **Estante** inferior opcional reforzado con omega central.
- **Patas** de tubo 40x40mm con taco regulable hasta 60mm.

### Módulos con puertas:

- **Estante** base con doble omega de refuerzo.
- **Puertas correderas** con rodamiento superior de nylon.
- **Puertas batientes** con bisagra vertical pivotante.
- **Patas** cilíndricas de acero inoxidable 150mm regulables hasta 50mm.



**Montaje rápido y fácil**  
Se suministran desmontados.  
Montaje fácil y rápido mediante tornillería.



**Totalmente soldados**  
Se suministran totalmente montados y soldados al fregadero elegido.



DIM (mm)	BASTIDOR	PVP	ESTANTE	PVP
1000	IDL1077D	<b>270</b>	IDL1070E	<b>155</b>
1200	IDL1277D	<b>282</b>	IDL1270E	<b>184</b>
1400	IDL1477D	<b>299</b>	IDL1470E	<b>207</b>
1600	IDL1677D	<b>339</b>	IDL1670E	<b>242</b>
1800	IDL1877D	<b>357</b>	IDL1870E	<b>265</b>
2000	IDL2077D	<b>380</b>	IDL2070E	<b>288</b>

P. COR.	PVP	P. BAT.	PVP
IDL47010	<b>759</b>	IDL41070 2P	<b>886</b>
IDL47012	<b>817</b>	IDL41270 2P	<b>937</b>
IDL47014	<b>840</b>		
IDL47016	<b>909</b>		
IDL47018	<b>943</b>		
IDL47020	<b>1024</b>		

PVP en €

## FREGADEROS FONDO 600/700

### Con aro de desbarace

- **Aro** desbarace troncocónico de caucho gris.
- **Frontal** soldado de 60mm en punto redondo, **peto** posterior soldado de 100mm con radio sanitario.
- **Incluye** válvula desagüe y tubo rebosadero.

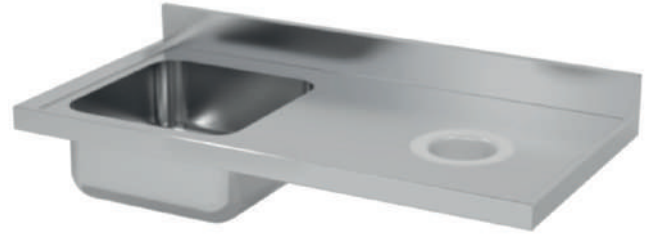
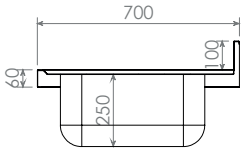

## FREGADEROS CON BASTIDOR SOLDADO FONDO 600/700 H.850

### Con aro de desbarace

- **Estante** inferior opcional reforzado con omega central.
- **Espacio lavavajillas** 600x600x740mm estándar.
- **Delantal** frente cuba opcional.
- **Patas** de tubo 40x40mm con taco regulable hasta 60mm.

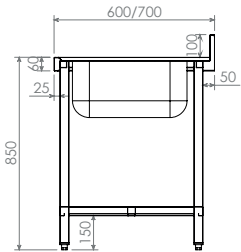

Totalmente soldados

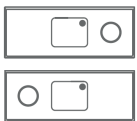
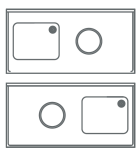

DIM (mm)	CUBA	REF	PVP	REF	PVP	REF	PVP	
1400x600	cuba D	500x400x250	IDL6114D	<b>552</b>	IDL6314D	<b>857</b>	IDL6414D	<b>978</b>
1400x600	cuba I	500x400x250	IDL6114I	<b>552</b>	IDL6314I	<b>857</b>	IDL6414I	<b>978</b>
1400x700	cuba D	500x500x250	IDL7114D	<b>564</b>	IDL7314D	<b>903</b>	IDL7414D	<b>1029</b>
1400x700	cuba I	500x500x250	IDL7114I	<b>564</b>	IDL7314I	<b>903</b>	IDL7414I	<b>1029</b>
1800x600	1c/ 1e D	500x400x250	IDL6118D	<b>776</b>	IDL6318D	<b>1144</b>	IDL6418D	<b>1311</b>
1800x600	1c/ 1e I	500x400x250	IDL6118I	<b>776</b>	IDL6318I	<b>1144</b>	IDL6418I	<b>1311</b>
1800x600	1c/ 1e D	500x400x250	IDL6118D	<b>776</b>	IDL6618D	<b>1070</b>	IDL6718D	<b>1231</b>
1800x600	1c/ 1e I	500x400x250	IDL6118I	<b>776</b>	IDL6618I	<b>1070</b>	IDL6718I	<b>1231</b>
1800x700	1c/ 1e D	500x500x250	IDL7118D	<b>805</b>	IDL7318D	<b>1185</b>	IDL7418D	<b>1346</b>
1800x700	1c/ 1e I	500x500x250	IDL7118I	<b>805</b>	IDL7318I	<b>1185</b>	IDL7418I	<b>1346</b>
1800x700	1c/ 1e D	500x500x250	IDL7118D	<b>805</b>	IDL7618D	<b>1133</b>	IDL7718D	<b>1242</b>
1800x700	1c/ 1e I	500x500x250	IDL7118I	<b>805</b>	IDL7618I	<b>1133</b>	IDL7718I	<b>1242</b>

Espacio lavavajillas

PVP en €

## ACCESORIOS Y RECAMBIOS FREGADEROS Y MESAS DE LAVADO

Delantales para fregaderos con aro desbarace o mesas lavavajillas

Opción de suministrar totalmente montados con la compra conjunta del fregadero.

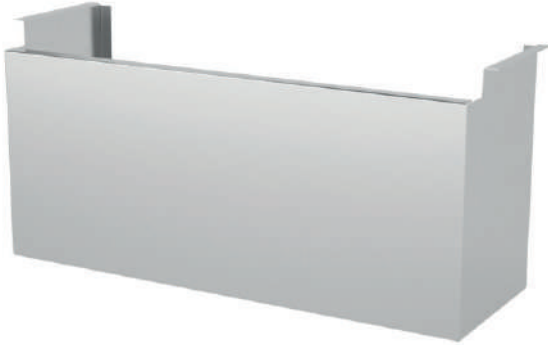

CARACTERÍSTICAS	REF	PVP (€)
Delantal derecho	IDL45099D	138
Delantal izquierdo	IDL45099I	138
Delantal central	IDL45099C	138



Adaptación temporizadores de agua

REF	PVP (€)
IDL45625	219
Adaptación de caño + pulsador temporizado + mezclador 2 aguas	
IDL45700	604
Adaptación de sensor + electroválvula + mezclador 2 aguas + caño.	



## FREGADEROS

Vertedero soldados

- **Frontal** de 60mm en punto redondo, peto posterior soldado de 100mm con radio sanitario.
- **Rejilla** superior móvil para soporte recipientes.
- **Incluye** válvula desagüe y tubo rebosadero.
- **Patas** de tubo 40x40mm con taco regulable hasta 60mm.

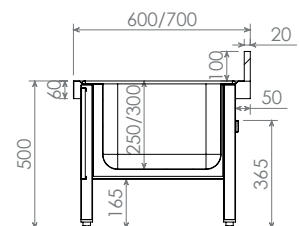

DIM (mm)	REF	PVP (€)
600x600x500	IDL60600	615
700x700x500	IDL70700	679



Totalmente soldado

## PETOS LATERALES

### Fregaderos fondo 600/700

- **Fijación** lateral a fregaderos mediante tornillos o remaches.

DIM (mm)	REF	PVP (€)
600x20x100mm derecho	IDL2260D	127
700x20x100mm derecho	IDL2270D	132
600x20x100mm izquierdo	IDL2260I	127
700x20x100mm izquierdo	IDL2270I	132

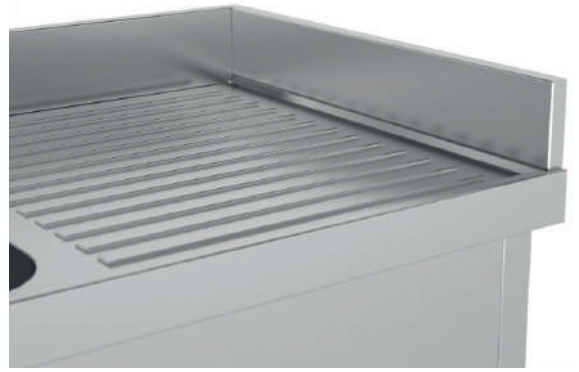

## PLAFONES LATERALES

### Bastidores fregaderos

- **Fijación** lateral a bastidores mediante tornillos.

**Opción de suministrar totalmente montado con la compra conjunta del bastidor soldado.**

DIM (mm)	REF	PVP (€)
Plafón lateral para bastidor fregadero fondo 600mm	IDL25600	98
Plafón lateral para bastidor fregadero fondo 700mm	IDL25700	104



## PUERTAS BATIENTES

### Bastidores fregaderos

- **Bisagras** verticales desmontables.
- **Largo** máximo de puerta 650mm.

**Opción de suministrar totalmente montada con la compra conjunta del bastidor soldado.**

DIM (mm)	REF	PVP (€)
Puerta frontal para bastidor fregadero (max. 650mm)	IDL25000	219



## PEANAS LAVAVAJILLAS

- **Soportes** laterales de sujeción, **marco** perimetral en chapa 2mm.
- **Patás** de tubo 40x40mm con taco regulable hasta 60mm.

**Medidas especiales en gama flexi estándar página 207.**

DIM (mm)	REF	PVP (€)
510x510x120	IDL90050	265
610x610x120	IDL90060	299



## CUERPO DE GUÍAS CESTAS DE LAVADO PARA MESAS LAVAVAJILLAS

- Preparado para **sujeción** a estante de mesas de lavado.

DIM (mm)	REF	PVP (€)
570x665x590 cerrado	IDH04555	<b>633</b>
550x665x590 abierto	IDH04655	<b>527</b>

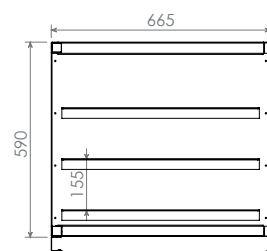

## SOPORTES Y CARTELAS PARA FREGADEROS

- Preparadas para soportar los **fregaderos**.

**Incluyen tacos y tornillos para su instalación.**



fondo 600

fondo 700

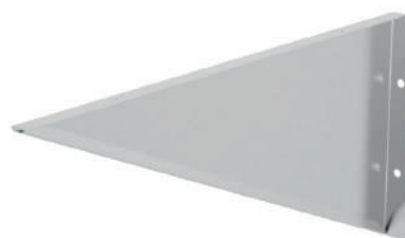

	REF	PVP (€)
Soporte con pata para fregadero fondo 600mm	IDH08566	<b>144</b>
Soporte central de tubo para fregadero fondo 600mm	IDH08576	<b>115</b>
Cartela de sujeción derecha en chapa de 1,5 mm para fregadero fondo 600mm	IDH04586D	<b>52</b>
Cartela de sujeción izquierda en chapa de 1,5 mm para fregadero fondo 600mm	IDH04586I	<b>52</b>
Soporte con pata para fregadero fondo 700mm	IDH08567	<b>155</b>
Soporte central de tubo para fregadero fondo 700mm	IDH08577	<b>121</b>
Cartela de sujeción derecha en chapa de 1,5 mm para fregadero fondo 700mm	IDH04587D	<b>58</b>
Cartela de sujeción izquierda en chapa de 1,5 mm para fregadero fondo 700mm	IDH04587I	<b>58</b>



## MESAS LAVAVAJILLAS SOLDADAS

### Mesas entrada murales: Con cuba

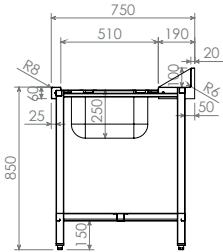

Totalmente soldadas

#### ENGATILLADO DERECHO

DIM (mm)	MARCO REF	PVP (€)	1 ESTANTE	PVP (€)
700x750x850	IDL80070D	<b>1064</b>	IDL81070D	<b>1139</b>
1200x750x850	IDL80120D	<b>1173</b>	IDL81120D	<b>1248</b>
1600x750x850	IDL80160D	<b>1300</b>	IDL81160D	<b>1374</b>
2100x750x850	IDL80210D	<b>1432</b>	IDL81210D	<b>1512</b>

#### ENGATILLADO IZQUIERDO

DIM (mm)	MARCO REF	PVP (€)	1 ESTANTE	PVP (€)
700x750x850	IDL80070I	<b>1064</b>	IDL81070I	<b>1139</b>
1200x750x850	IDL80120I	<b>1173</b>	IDL81120I	<b>1248</b>
1600x750x850	IDL80160I	<b>1300</b>	IDL81160I	<b>1374</b>
2100x750x850	IDL80210I	<b>1432</b>	IDL81210I	<b>1512</b>

- **Frontal** soldado de 60mm en punto redondo, **peto** posterior soldado de 100mm con radio sanitario.
- Perfil guía **salvaaguas**.
- **Engatillado** de 22 a 5mm mediante regulación.
- **Aro** desbarace en caucho negro.
- **Estante** opcional reforzado con omega central.
- **1 cuba** soldada 500x400x250mm.
- **Incluye** válvula desagüe y tubo rebosadero.
- **Delantal** frente cuba opcional.
- **Patas** de tubo 40x40mm con taco regulable hasta 60mm.



### Mesas entrada murales: Con cuba+aro

#### ENGATILLADO DERECHO

DIM (mm)	MARCO REF	PVP (€)	1 ESTANTE	PVP (€)
1200x750x850	IDL82120D	<b>1357</b>	IDL83120D	<b>1432</b>
1600x750x850	IDL82160D	<b>1484</b>	IDL83160D	<b>1570</b>
2100x750x850	IDL82210D	<b>1622</b>	IDL83210D	<b>1719</b>

#### ENGATILLADO IZQUIERDO

DIM (mm)	MARCO REF	PVP (€)	1 ESTANTE	PVP (€)
1200x750x850	IDL82120I	<b>1357</b>	IDL83120I	<b>1432</b>
1600x750x850	IDL82160I	<b>1484</b>	IDL83160I	<b>1570</b>
2100x750x850	IDL82210I	<b>1622</b>	IDL83210I	<b>1719</b>



# 02.

## MESAS LAVAVAJILLAS SOLDADAS

### Mesas salida murales

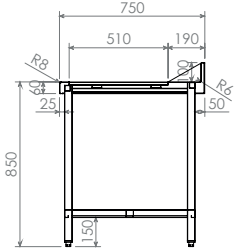

Totalmente soldadas

- **Frontal** soldado de 60mm en punto redondo, **peto** posterior soldado de 100mm con radio sanitario.
- Perfil guía **salvaaguas**.
- **Engatillado** de 22 a 5mm mediante regulación.
- **Aro** desbarace en caucho negro.
- **Estante** opcional reforzado con omega central.
- **Patas** de tubo 40x40mm con taco regulable hasta 60mm.

#### ENGATILLADO DERECHO

DIM (mm)	MARCO REF	PVP (€)	1 ESTANTE	PVP (€)
700x750x850	IDL84070D	<b>748</b>	IDL85070D	<b>863</b>
1200x750x850	IDL84120D	<b>822</b>	IDL85120D	<b>897</b>
1600x750x850	IDL84160D	<b>920</b>	IDL85160D	<b>995</b>
2100x750x850	IDL84210D	<b>1018</b>	IDL85210D	<b>1110</b>



#### ENGATILLADO IZQUIERDO

DIM (mm)	MARCO REF	PVP (€)	1 ESTANTE	PVP (€)
700x750x850	IDL84070I	<b>748</b>	IDL85070I	<b>863</b>
1200x750x850	IDL84120I	<b>822</b>	IDL85120I	<b>897</b>
1600x750x850	IDL84160I	<b>920</b>	IDL85160I	<b>995</b>
2100x750x850	IDL84210I	<b>1018</b>	IDL85210I	<b>1110</b>



### Mesas salida centrales reversibles

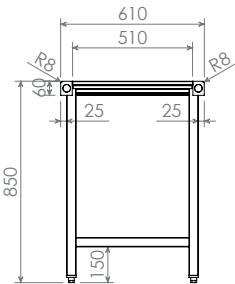

DIM (mm)	MARCO REF	PVP (€)	1 ESTANTE	PVP (€)
700x610x850	IDL86070	<b>592</b>	IDL87070	<b>650</b>
1200x610x850	IDL86120	<b>679</b>	IDL87120	<b>719</b>
1600x610x850	IDL86160	<b>759</b>	IDL87160	<b>799</b>
2100x610x850	IDL86210	<b>828</b>	IDL87210	<b>868</b>



## MESAS LAVAVAJILLAS

### Rodillos soldadas

- **Frontal** soldado de 60mm en punto redondo, **peto** posterior soldado de 100mm con radio sanitario.
- Perfil guía **salvaaguas**.
- **Válvula** desagüe inferior.
- **Engatillado** de 22 a 5mm mediante regulación.
- **Parrillas** extraíbles de rodillos pvc con rodamientos de acero inox.
- **Estante** opcional reforzado con omega central.
- **Patas** de tubo 40x40mm con taco regulable hasta 60mm.

Totalmente soldadas



### Mesas salida rodillos

#### Murales reversibles

DIM (mm)	MARCO REF	PVP (€)	1 ESTANTE	PVP (€)
700x750x850	IDL80740	<b>1213</b>	IDL80750	<b>1242</b>
1200x750x850	IDL81240	<b>1478</b>	IDL81250	<b>1507</b>
1600x750x850	IDL81640	<b>1754</b>	IDL81650	<b>1794</b>
2100x750x850	IDL82140	<b>2381</b>	IDL82150	<b>2450</b>

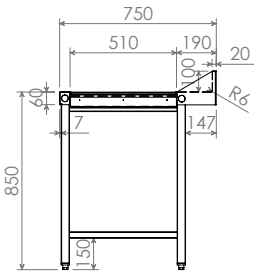

### Mesas salida rodillos

#### Centrales reversibles

DIM (mm)	MARCO REF	PVP (€)	1 ESTANTE	PVP (€)
700x650x850	IDL80760	<b>1144</b>	IDL80770	<b>1202</b>
1200x650x850	IDL81260	<b>1397</b>	IDL81270	<b>1455</b>
1600x650x850	IDL81660	<b>1696</b>	IDL81670	<b>1737</b>
2100x650x850	IDL82160	<b>2277</b>	IDL82170	<b>2358</b>

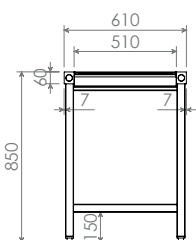

**NUEVO MODELO**

## Mesa salida rodillos Angular reversible

- **Frontal** soldado de 60mm en punto redondo, **peto** posterior soldado de 100mm.
- **Válvula** desagüe inferior.
- **Engatillado** de 22 a 5mm mediante regulación.
- **Parrilla** extraíble de rodillos pvc con rodamientos de acero inox.
- **Patas** de tubo 40x40mm con taco regulable hasta 60mm.

Totalmente soldada



DIM (mm)	MARCO REF	PVP (€)
1100x1100x850	IDL810DS	<b>2317</b>

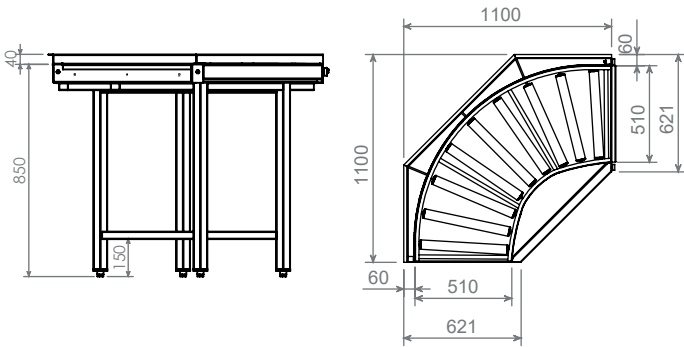

## Mesas recepción/clasificación Soldadas

- **Frontal** soldado de 60mm en punto redondo.
- **Aro** desbarace en caucho negro.
- **Espacio** inferior de 450mm para cubo.
- **Estante** opcional reforzado con omega central.
- **Patas** de tubo 40x40mm con taco regulable hasta 60mm.

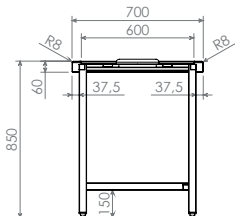

Totalmente soldadas



DIM (mm)	MARCO REF	PVP (€)	1 ESTANTE	PVP (€)
1200x700x850	IDL88120	<b>1121</b>	IDL89120	<b>1248</b>
1600x700x850	IDL88160	<b>1242</b>	IDL89160	<b>1374</b>
2100x700x850	IDL88210	<b>1472</b>	IDL89210	<b>1627</b>

## ENCIMERA SALIDA

### Lavavajillas

- Perfil guía **salvaaguas**.
- **Engatillado** de 22 a 5mm mediante regulación.

DIM (mm)	REF	PVP (€)
600x610x300	IDL84000	391

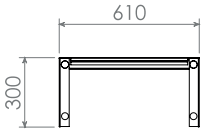

## ESTANTERÍAS SOBREMESA

### Cestas de lavado

- **Barra** central apoyo cestas de lavado
- **Desagüe** inferior.

Medidas especiales en gama flexi estándar página 207.

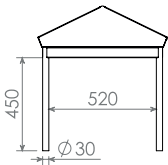

DIM (mm)	REF	PVP (€)
600x625x500+200	IDP55060	604
1200x625x500+200	IDP55120	656
1600x625x500+200	IDP55160	690
2100x625x500+200	IDP55210	782



Totalmente soldadas

## ESTANTERÍAS MURALES

### Cestas de lavado

- Inclinas con desagüe inferior.

Medidas especiales en gama flexi estándar página 207.

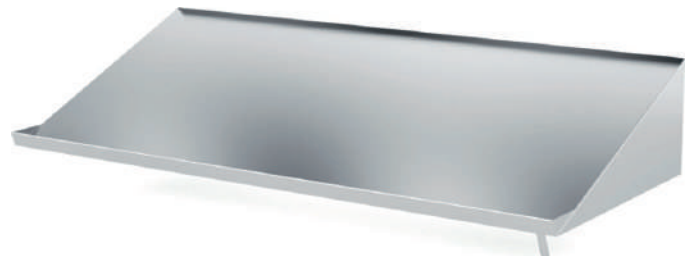
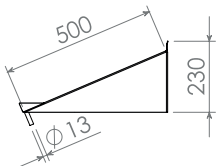

DESAGÜE DERECHO

DESAGÜE IZQUIERDO

DIM (mm)	REF	PVP (€)	REF	PVP (€)
600x500x230	IDP55006D	334	IDP55006I	334
1100x500x230	IDP55011D	403	IDP55011I	403
1600x500x230	IDP55016D	472	IDP55016I	472
2100x500x230	IDP55021D	552	IDP55021I	552



# 02.

## FONDOS PERFORADOS

### Inoxidable prelavado

- Se adaptan al **interior** de la cuba.

DIM (mm)	CUBA	REF	PVP (€)
348x348x15	400x400	IDL4040	104
398x398x15	450x450	IDL4545	109
445x345x15 dcha.	500x400	IDL5040D	115
445x345x15 izq.	500x400	IDL5040I	115
448x448x15	500x500	IDL5050	121
545x445x15 dcha.	600x500	IDL6050D	127
581x445x15 izq.	600x500	IDL6050I	127



## CESTAS

### Inoxidable prelavado

- Se adaptan al **interior** de la cuba, asas interiores para agarre.

DIM (mm)	CUBA	REF	PVP (€)
382x382x100	400x400	IDL34040	207
432x432x100	450x450	IDL34545	219
482x382x100	500x400	IDL35040	230
482x482x100	500x500	IDL35050	242
582x482x100	600x500	IDL36050	265



## AROS Y TAPAS DESBARACE

	REF	PVP (€)
Goma para aro desbarace 200ø negro	IDL45000	24
Goma para aro desbarace 200ø amarillo	IDL45002	24
Goma para aro desbarace 200ø verde	IDL45003	24
Goma para aro desbarace 200ø azul	IDL45004	24
Goma para aro desbarace 200ø rojo	IDL45007	24
Tapa para aro desbarace 200ø	IDL45001	46
Goma para aro desbarace troncocónico 216ø	IDL45005	69
Tapa para aro desbarace troncocónico 216ø	IDL45006	46



## LAVAMANOS

- **Peto** posterior 30mm en punto recto.
- **Cubeta** de 365x340x150mm con caño giratorio.
- **Válvula** desagüe con tapón incluidos.
- **Puerta** frontal registrable.
- **Caño alto** y **pulsador** temporizado en los modelos 1 agua y 2 aguas, latiguillos de 1/2 incluidos.
- **Sensor** con electroválvula + mezclador en modelos electrónicos.

# 02.

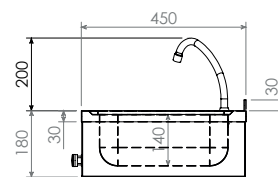
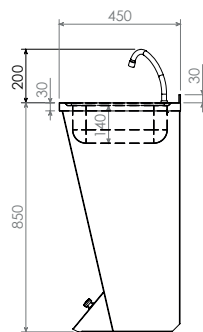

### Pie

DIM (mm)		REF	PVP (€)
450x450x850	Pulsador 1 agua	IDL45085	403
450x450x850	Doble pulsador 2 aguas	IDL45090	483
450x450x850	Pulsador + mezclador 2 aguas	IDL45095	460
450x450x850	Electrónico 2 aguas	IDL45096	811



Doble pulsador 2 aguas



Electrónico

### Mural

DIM (mm)		REF	PVP (€)
450x450x180	Pulsador 1 agua	IDL45118	305
450x450x180	Pulsador + mezclador 2 aguas	IDL45228	334
450x450x180	Electrónico 2 aguas	IDL45229	650



Pulsador 1 agua



Electrónico

## NOVEDAD

### Autónomo

- Accionador hidráulico de **pedal** en parte inferior, 2 **garrafas** 10 litros (1 para agua limpia y otra para agua sucia).
- 1 asa + 2 ruedas posteriores para **transporte**.

DIM (mm)	REF	PVP (€)
500x500x850	IDL45086	1110



## NOVEDAD

### Vertedero

- **Frontal** soldado de 30mm, **peto** posterior soldado de 60mm con radio sanitario.
- 1 **cuba** superior trapezoidal + 1 cuba inferior 400x400x200mm cantos sanitarios.
- Diseñado para llenado y vaciado de grandes recipientes.
- **Rejilla** móvil en cuba inferior para apoyo.

DIM (mm)	REF	PVP (€)
500x700x850	IDL50700	1093

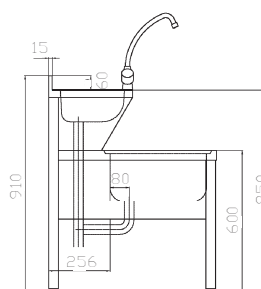

## ACCESORIOS Y RECAMBIOS MESAS LAVADO Y LAVAMANOS

### Peto trasero lavamanos

DIM (mm)	REF	PVP (€)
450x20x300	IDL45660	63
500x20x300	IDL45661	69



### Dispensadores

REF	PVP (€)
IDL45665	86

Dispensador mural de jabón 0.8L acero inoxidable  
110x110x180mm

REF	PVP (€)
IDL45670	213

Dispensador mural acero inox, bobina papel  
mecha Ø250x320mm



### Separador agua-aceite

- **Entrada** de agua residual en 1 lateral.
- Sistema interno de **separación** de grasas y sólidos por diferencias de densidad en los materiales.
- **Salida** de agua libre de grasas por lateral opuesto.
- **Patas** regulables con taco de nylon.

DIM (mm)	REF	PVP (€)
500x405x400	IDL95010	46 litros 1121

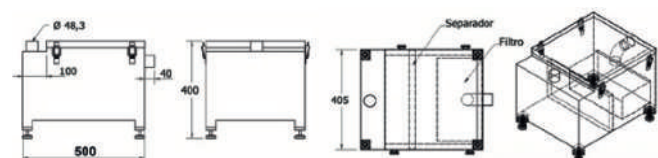

NOVEDAD

## CAÑÓN DE OZONO

- **Ventiladores** helicoidales con filtros antipolvo.
- **Interruptor** ON/OFF iluminado.
- **Jaula** de alta tensión para célula de ozono con fusible de protección.
- **Temperatura** de trabajo  $-5^{\circ}$   $+45^{\circ}$  C.
- **Protección** IP20.
- **Programador** con temporizador de 20 programas.
- **Asa** ergonómica para su transporte.
- **Alimentación** con cable Shuko.
- **Patas** inferiores antideslizantes.

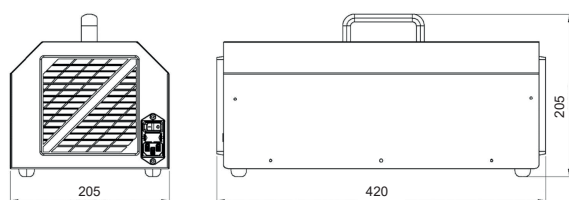

	IDZON020	IDZON045	IDZON070
PRECIO (€)	<b>645</b>	<b>917</b>	<b>1070</b>

## EXPOSICIÓN

Capacidad máxima	20g/h	45g/h	70g/h
Estancias	30-100m <sup>2</sup>	200-300 <sup>2</sup>	200-300 <sup>2</sup>
Tiempo	15-45 min	35-50 min	25-40 min

## CARACTERÍSTICAS

Nº de células de generación	1	2	3
Capacidad máxima	20g/h	45g/h	70g/h

## CARACTERÍSTICAS DEL AMBIENTE

Higrometría	80%
Polvo	< 7mg/l
Temperatura	< 45°C

## ALIMENTACIÓN

Tensión red	220-240Vac		
Frecuencia red	50/60Hz		
Potencia absorbida	30VA	40VA	50VA

## FLUJO DE AIRE

Ventilación forzada	Ventilador propulsor con filtro antipolvo + Ventilador extractor con filtro antipolvo
---------------------	---

## CONTROL

Encendido y apagado	Conmutador bipolar luminoso
Temporizador	Temporizador programable

## DIMENSIONES

Largo x Alto x Fondo	420x205x205mm
Peso	8 Kg

## DISPENSADORES GEL HIDROALCOHÓLICO

### Soporte dispensador

- Soportes para **dispensadores** de gel.
- Con posibilidad de llevar **caja** dispensadora para guantes/pañuelos en la parte superior.

	REF	CAJA GUANTES	PVP (€)
RECIPIENTE GEL	IDL45320	IDL45300	127
Soporte dispensador con recipiente frontal 120x120x10mm para botella de gel.			
RECIPIENTE GEL + PEDAL	IDL45322	IDL45302	242
Soporte dispensador frontal 120x120x10 con pedal inferior para accionamiento de pulsador de gel.			
SOPORTE DISPENSADOR MURAL	IDL45321	IDL45301	127
Soporte dispensador frontal 120x120x10 para dispensador mural de gel.			
ELECTRÓNICO AUTÓNOMO	IDL45323	IDL45303	546
Soporte dispensador automático de gel mediante sensor. Funciona con 8 pilas de 1.5V. Registro trasero para garrafa de gel.			



**Montaje rápido y fácil**  
Se suministran desmontados.

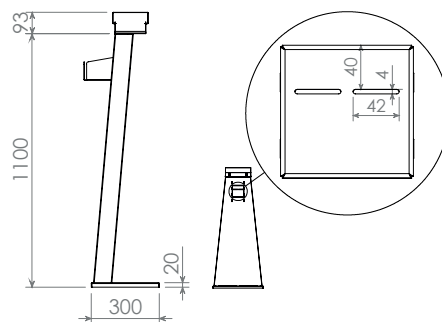

SIMPLE



CON CAJA  
GUANTES



GEL CON  
CAJA GUANTES



PEDAL CON  
CAJA GUANTES



MURAL CON  
CAJA GUANTES



ELECTRÓNICO CON  
CAJA GUANTES

### Accesorios

- **Caja** dispensadora para guantes/pañuelos 252x157x93mm.
- **Banderola** publicidad/soporte DIN A4 250x157x400mm.

	REF	PVP (€)
CAJA GUANTES/PAÑUELOS	IDL45304	29
BANDEROLA	IDL45305	17









# 03.

- Sumideros sifónicos
- Canales cocina
- Rosetas
- Tramex y rejas

## SUMIDEROS SIFÓNICOS

# 03.

- Sumideros estancos totalmente soldados.
- Provistos de sistema de **retención** sifónico y cestillo para recogida de sólidos.

**Para medidas y acabados especiales consultar precio.**

**Opción de rejas tramex, chapa o rosetas en página 47.**

### Salida vertical

DIM (mm)	CAUDAL	REF	PVP (€)
160x160x116 • salida 40Ø	1800 l/h	IDL151SV	<b>144</b>
210x210x165 • salida 89Ø	4300 l/h	IDL202SV	<b>162</b>
310x310x234 • salida 114Ø	5600 l/h	IDL303SV	<b>192</b>
210x210x94 • salida 89Ø altura reducida	4300 l/h	IDL202VR	<b>126</b>
310x310x126 • salida 114Ø altura reducida	5600 l/h	IDL303VR	<b>138</b>

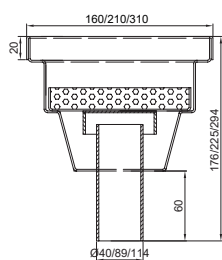

ALTURA NORMAL

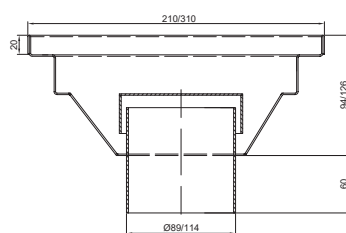

ALTURA REDUCIDA

### Salida horizontal

DIM (mm)	CAUDAL	REF	PVP (€)
160x160x116 • salida 39Ø	650 l/h	IDL151SH	<b>156</b>
210x210x170 • salida 89Ø	2800 l/h	IDL202SH	<b>174</b>
310x310x220 • salida 114Ø	4600 l/h	IDL303SH	<b>192</b>
210x210x157 • salida 89Ø altura reducida	2800 l/h	IDL202HR	<b>150</b>
310x310x181 • salida 114Ø altura reducida	4600 l/h	IDL303HR	<b>180</b>

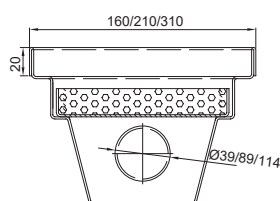

ALTURA NORMAL

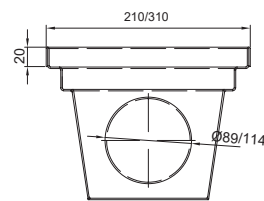
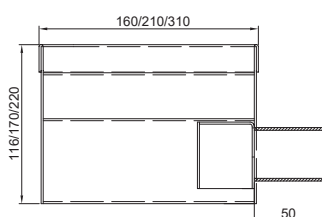

ALTURA REDUCIDA

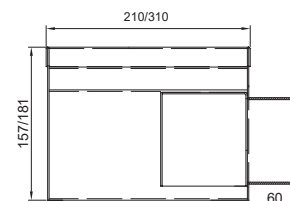



- Canales y sumideros estancos totalmente **soldados**.
- Provistos de sistema de **retención** sifónico y cestillo para recogida de sólidos.

**Para medidas y acabados especiales consultar precio.**

**Opción de rejas tramex, chapa o rosetas en página 47.**

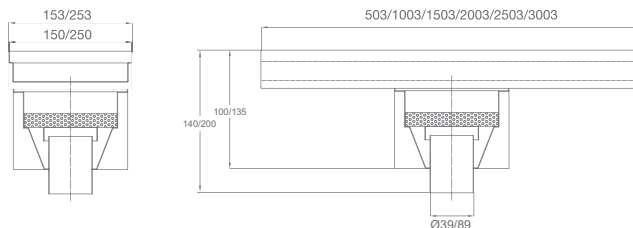

### Salida vertical / Caudal 1800 l/h.

DIM (mm)	REF	PVP (€)
503x153x50/140 • salida 39Ø	IDL1505V	<b>252</b>
1003x153x50/140 • salida 39Ø	IDL1510V	<b>342</b>
1503x153x50/140 • salida 39Ø	IDL1515V	<b>384</b>
2003x153x50/140 • salida 39Ø	IDL1520V	<b>444</b>
2503x153x50/140 • salida 39Ø	IDL1525V	<b>510</b>
3003x153x50/140 • salida 39Ø	IDL1530V	<b>570</b>

### Salida vertical / Caudal 4300 l/h.

DIM (mm)	REF	PVP (€)
503x253x50/200 • salida 89Ø	IDL2505V	<b>372</b>
1003x253x50/200 • salida 89Ø	IDL2510V	<b>450</b>
1503x253x50/200 • salida 89Ø	IDL2515V	<b>528</b>
2003x253x50/200 • salida 89Ø	IDL2520V	<b>600</b>
2503x253x50/200 • salida 89Ø	IDL2525V	<b>678</b>
3003x253x50/200 • salida 89Ø	IDL2530V	<b>768</b>

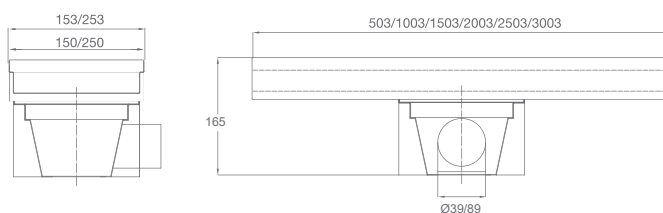

### Salida horizontal / Caudal 650 l/h.

DIM (mm)	REF	PVP (€)
503x153x50/155 • salida 39Ø	IDL1505H	<b>270</b>
1003x153x50/155 • salida 39Ø	IDL1510H	<b>330</b>
1503x153x50/155 • salida 39Ø	IDL1515H	<b>390</b>
2003x153x50/155 • salida 39Ø	IDL1520H	<b>462</b>
2503x153x50/155 • salida 39Ø	IDL1525H	<b>528</b>
3003x153x50/155 • salida 39Ø	IDL1530H	<b>588</b>

### Salida horizontal / Caudal 2800 l/h.

DIM (mm)	REF	PVP (€)
503x253x50/165 • salida 89Ø	IDL2505H	<b>384</b>
1003x253x50/165 • salida 89Ø	IDL2510H	<b>462</b>
1503x253x50/165 • salida 89Ø	IDL2515H	<b>540</b>
2003x253x50/165 • salida 89Ø	IDL2520H	<b>612</b>
2503x253x50/165 • salida 89Ø	IDL2525H	<b>696</b>
3003x253x50/165 • salida 89Ø	IDL2530H	<b>780</b>

## CANALES COCINA SALIDA DIRECTA

- Canales estancos totalmente **soldados**.

**Para medidas y acabados especiales consultar precio.**

Opción de rejas tramex, chapa o rosetas en página 47.

### NUEVO MODELO

Salida  
vertical

Ancho 153mm  
Salida Ø42,5mm  
Caudal 1800 l/h

Ancho 253mm  
Salida Ø60,5mm  
Caudal 3050 l/h

LONGITUD	REF	PVP (€)	REF	PVP (€)
503	IDL105DV	<b>102</b>	IDL205DV	<b>126</b>
1003	IDL110DV	<b>138</b>	IDL210DV	<b>168</b>
1503	IDL115DV	<b>186</b>	IDL215DV	<b>216</b>
2003	IDL120DV	<b>228</b>	IDL220DV	<b>270</b>
2503	IDL125DV	<b>288</b>	IDL225DV	<b>342</b>
3003	IDL130DV	<b>348</b>	IDL230DV	<b>408</b>

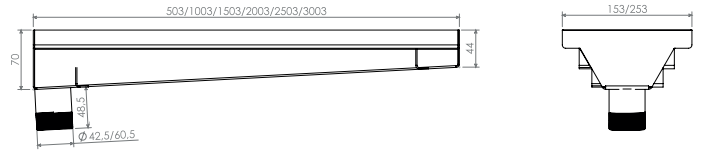

### NUEVO MODELO

Salida  
horizontal

Ancho 153mm  
Salida Ø42,5mm  
Caudal 1800 l/h

Ancho 253mm  
Salida Ø60,5mm  
Caudal 3050 l/h

LONGITUD	REF	PVP (€)	REF	PVP (€)
503	IDL105DH	<b>102</b>	IDL205DH	<b>126</b>
1003	IDL110DH	<b>138</b>	IDL210DH	<b>168</b>
1503	IDL115DH	<b>186</b>	IDL215DH	<b>216</b>
2003	IDL120DH	<b>228</b>	IDL220DH	<b>270</b>
2503	IDL125DH	<b>288</b>	IDL225DH	<b>342</b>
3003	IDL130DH	<b>348</b>	IDL230DH	<b>408</b>

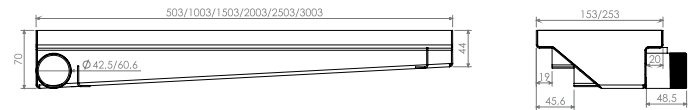

### NUEVO MODELO

Salida  
lateral

Ancho 153mm  
Salida Ø42,5mm  
Caudal 1800 l/h

Ancho 253mm  
Salida Ø60,5mm  
Caudal 3050 l/h

LONGITUD	REF	PVP (€)	REF	PVP (€)
503	IDL105DL	<b>102</b>	IDL205DL	<b>126</b>
1003	IDL110DL	<b>138</b>	IDL210DL	<b>168</b>
1503	IDL115DL	<b>186</b>	IDL215DL	<b>216</b>
2003	IDL120DL	<b>228</b>	IDL220DL	<b>270</b>
2503	IDL125DL	<b>288</b>	IDL225DL	<b>342</b>
3003	IDL130DL	<b>348</b>	IDL230DL	<b>408</b>





# 03.



## ROSETAS MODULARES DE CHAPA PERFORADA PARA SUMIDEROS Y CANALES DE COCINA

- Chapa de 2mm de espesor para sumideros, con perforaciones de  $\varnothing 22\text{mm}$  para desagüe.

DIM (mm)	REF	PVP (€)
150x150x20	IDLRC150	36
200x200x20	IDLRC200	60
300x300x20	IDLRC300	90

## TRAMEX PARA SUMIDEROS Y CANALES DE COCINA

- **Tramex** de chapa 2mm espesor, separación 23x23mm entre ejes.

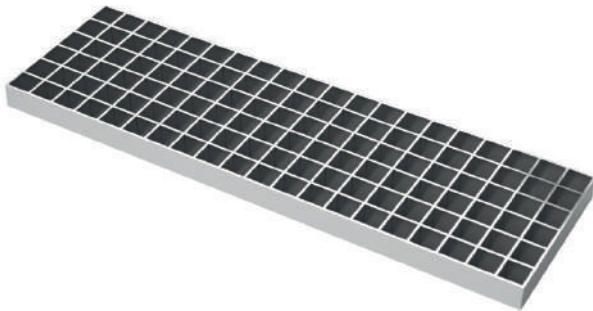

DIM (mm)	REF	PVP (€)
150x150x20	IDLRT150	84
200x200x20	IDLRT200	102
300x300x20	IDLRT300	150
500x150x20	IDLRT515	156
500x250x20	IDLRT525	192

## REJAS MODULARES PARA SUMIDEROS Y CANALES DE COCINA

- **Rejas** de chapa 1.5mm de espesor, separación 15mm entre lamas.

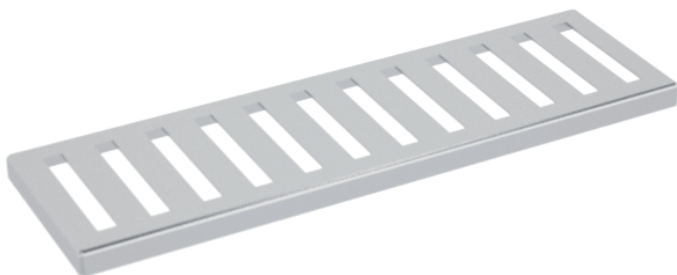

DIM (mm)	REF	PVP (€)
150x150x20	IDLRL150	72
200x200x20	IDLRL200	78
300x300x20	IDLRL300	90
500x150x20	IDLRL515	84
500x250x20	IDLRL525	114





# 04.

- Grifos monomando
- Grifos ducha
- Grifos altura reducida
- Mangueras lavado
- Caños y recambios



## MODELOS RENOVADOS

## GRIFOS MONOMANDO

Cada modelo dispone de recambios. Grifería industrial para profesionales, gran rendimiento y durabilidad.

Cromados alta densidad.

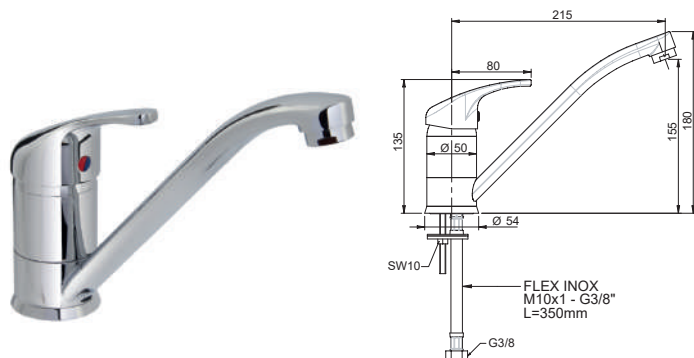

REF

PVP (€)

IDG03003

102

Grifo 2 aguas monomando corto, caño 155mm bajo.  
Cartucho recambio: IDG33362

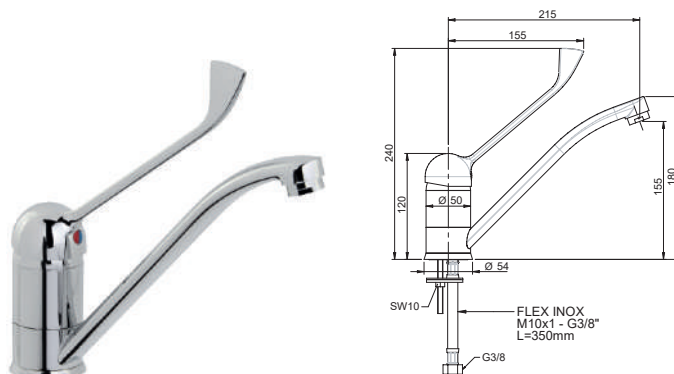

REF

PVP (€)

IDG03007

114

Grifo 2 aguas monomando largo, caño 155mm bajo.  
Cartucho recambio: IDG33362

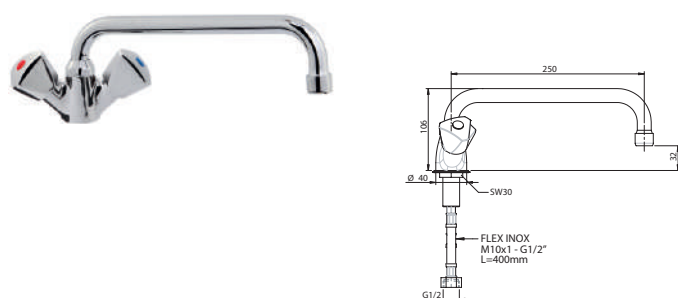

REF

PVP (€)

IDG03014

102

Grifo 2 aguas doble mando caño extra-bajo 106mm.  
Cartucho recambio: IDG33364 x2

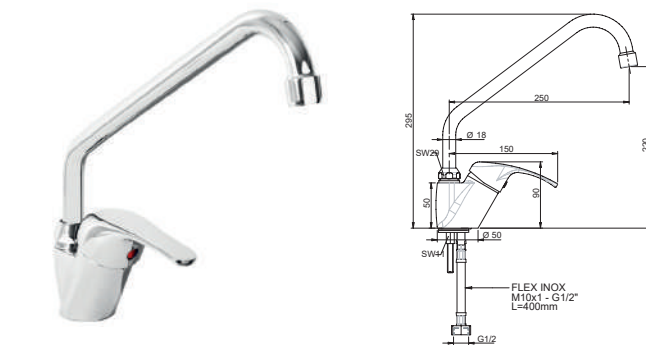

REF

PVP (€)

IDG03002

126

Grifo 2 aguas monomando corto, caño alto 220mm.  
Cartucho recambio: IDG33361

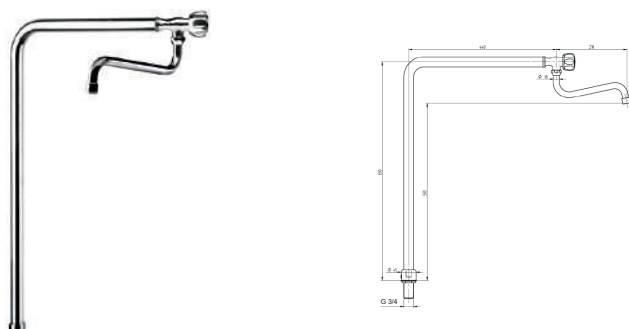

REF

PVP (€)

IDG03019

312

Grifo 1 agua de columna.  
Cartucho recambio: IDG33363

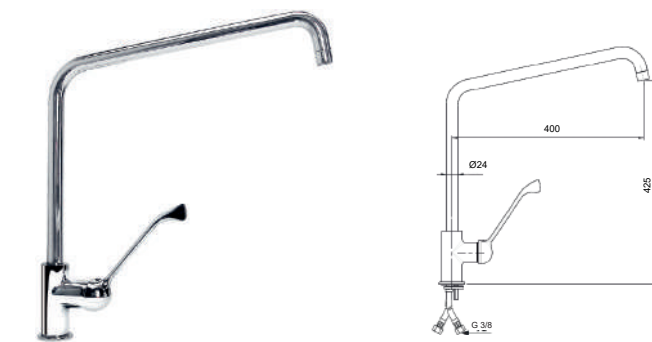

REF

PVP (€)

IDG03018

354

Grifo 2 aguas monomando largo, caño extra-alto 455mm.  
Cartucho recambio: IDG33367

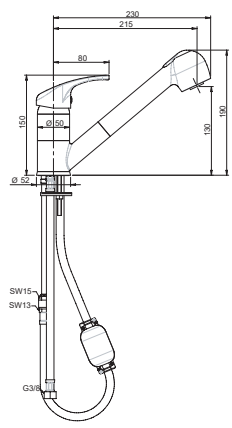

**REF** IDG03013 **PVP (€)** 174  
 Grifo 2 aguas monomando corto, caño ducha extraíble.  
 Cartucho recambio: IDG33362

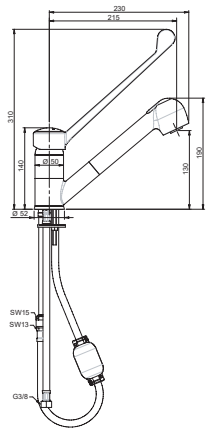

**REF** IDG03017 **PVP (€)** 192  
 Grifo 2 aguas monomando gerontológico, caño ducha extraíble.  
 Cartucho recambio: IDG33362

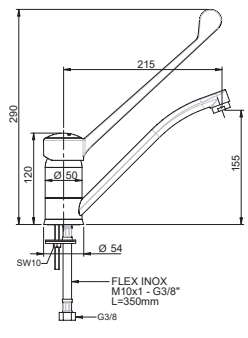

**REF** IDG03012 **PVP (€)** 174  
 Grifo 2 aguas monomando gerontológico caño corto.  
 Cartucho recambio: IDG33362

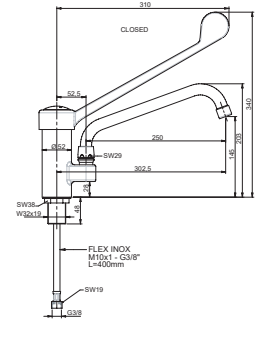

**REF** IDG03005 **PVP (€)** 210  
 Grifo 2 aguas monomando gerontológico caño largo.  
 Cartucho recambio: IDG33362

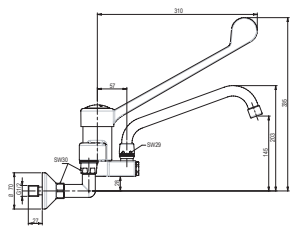

**REF** IDG03040 **PVP (€)** 344  
 Grifo 2 aguas monomando gerontológico MURAL.  
 Cartucho recambio: IDG33365

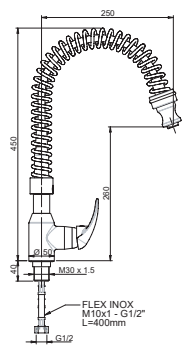

**REF** IDG33035 **PVP (€)** 285  
 Grifo 2 aguas monomando corto, caño muelle flexible.  
 Cartucho recambio: IDG33366



## GRIFOS DUCHA

Cada modelo dispone de recambios. Grifería industrial para profesionales, gran rendimiento y durabilidad.

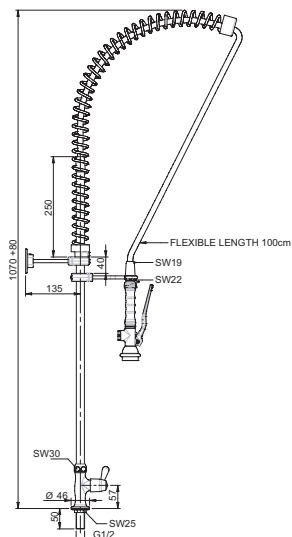

REF

PVP (€)

IDG03008

246

Grifo ducha 1 agua.  
Cartucho recambio: IDG33363

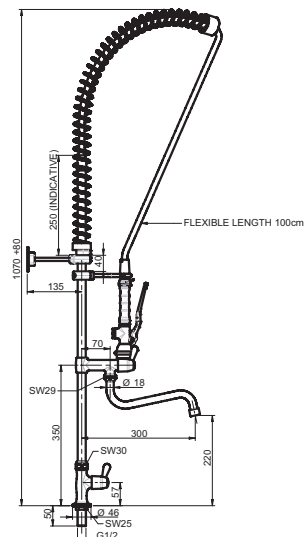

REF

PVP (€)

IDG03009

312

Grifo ducha 1 agua con grifo.  
Cartucho recambio: IDG33363 x2

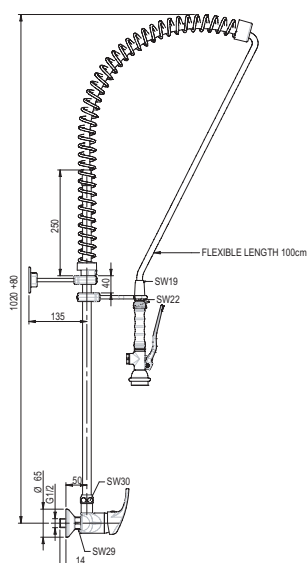

REF

PVP (€)

IDG03020

330

Grifo ducha mezclador 2 aguas MURAL.  
Cartucho recambio: IDG33362

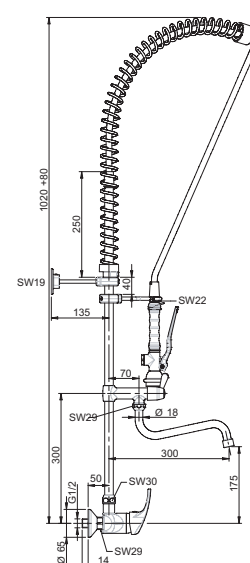

REF

PVP (€)

IDG03021

360

Grifo ducha mezclador monomando 2 aguas con grifo MURAL.  
Cartucho recambio: IDG33363 + IDG33362

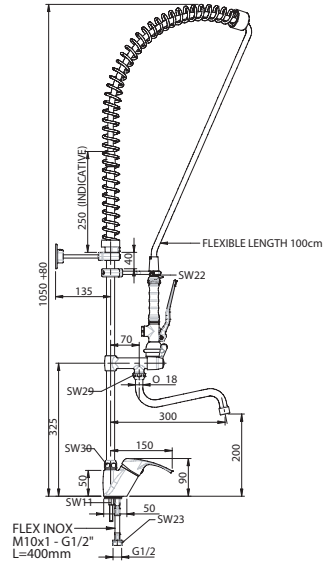
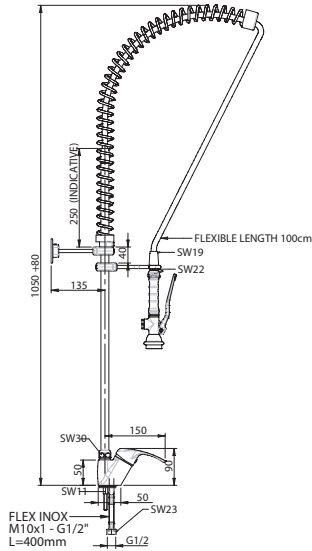

REF

PVP (€)

IDG03010

306

Grifo ducha mezclador monomando 2 aguas.  
Cartucho recambio: IDG33361

REF

PVP (€)

IDG03011

366

Grifo ducha mezclador monomando 2 aguas con grifo.  
Cartucho recambio: IDG33363 + IDG33361

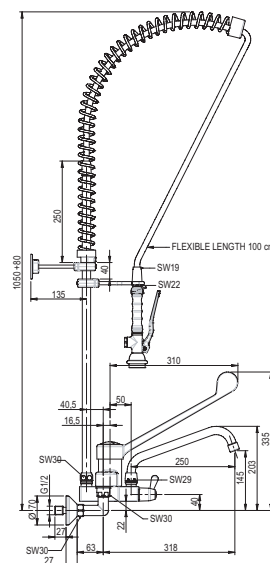
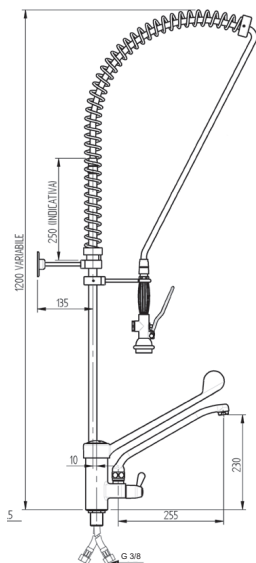

REF

PVP (€)

IDG03016

468

Grifo ducha mezclador monomando gerontológico 2 aguas.  
Cartucho recambio: IDG33363 + IDG33362

REF

PVP (€)

IDG03027

504

Grifo ducha mezclador monomando gerontológico 2 aguas MURAL.  
Cartucho recambio: IDG33363 + IDG33365

## MODELOS RENOVADOS

GRIFOS DUCHA  
ALTURA REDUCIDA

Grifería industrial para profesionales, gran rendimiento y durabilidad.

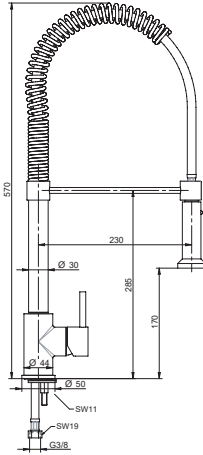

REF

PVP (€)

IDG33510

414

Grifo monomando caño muelle flexible.  
Recambio cartucho: IDG33367

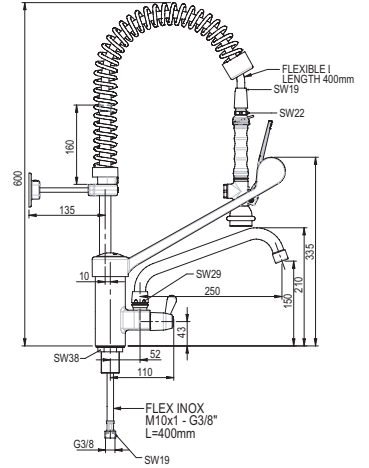

REF

PVP (€)

IDG3025

384

Grifo 2 aguas monom. Gerontológico ducha posterior altura 600mm.  
Cartucho recambio: IDG33363 + IDG33362

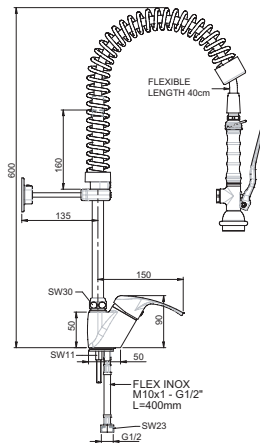

REF

PVP (€)

IDG03106

330

Grifo ducha mezclador monomando 2 aguas altura 600mm.  
Cartucho recambio: IDG33361

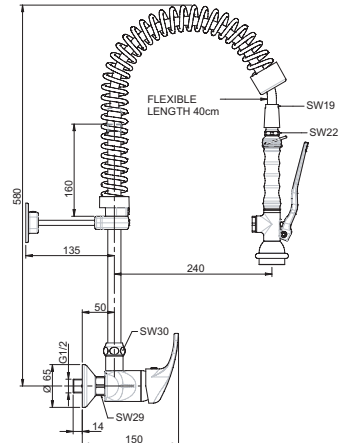

REF

PVP (€)

IDG03107

354

Grifo ducha mezclador monomando 2 aguas, altura 600mm MURAL.  
Cartucho recambio: IDG33362

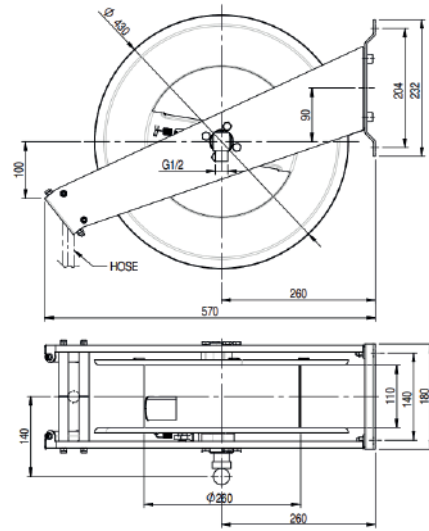

REF	PVP (€)
IDG03510	1416
Manguera para lavado ABIERTA en acero inox 10m + PISTOLA NITO	
IDG03515	1506
Manguera para lavado ABIERTA en acero inox 15m + PISTOLA NITO	

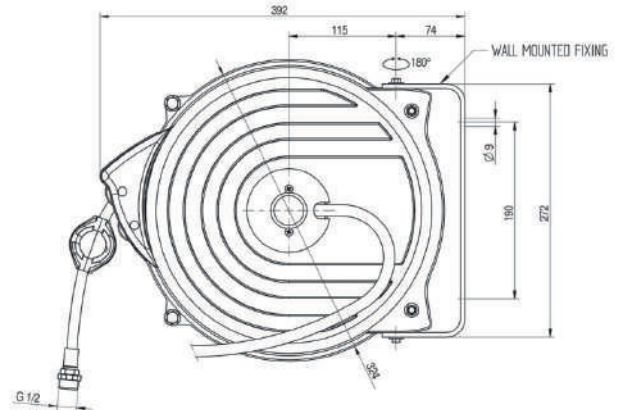

REF	PVP (€)
IDG03410	588
Manguera para lavado CERRADA en acero inox 10m + DUCHA	
IDG03415	654
Manguera para lavado CERRADA en acero inox 15m + DUCHA	

## CAÑOS Y RECAMBIOS

Grifería industrial para profesionales, gran rendimiento y durabilidad.

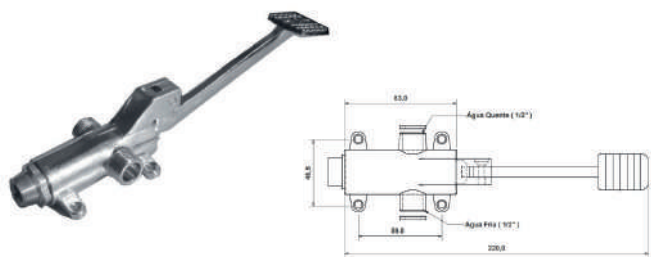

REF

PVP (€)

IDG03050

120

Grifo pedal automezclador 2 aguas económico

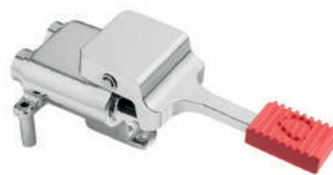

NUEVO MODELO

REF

PVP (€)

IDG03051

192

Grifo pedal automezclador 2 aguas

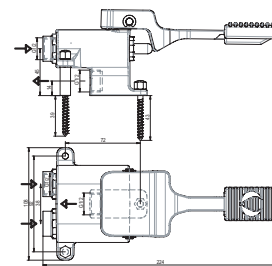

REF

PVP (€)

IDG03055

228

Grifo pedal doble 2 aguas



REF

PVP (€)

IDG03053

132

Pulsador palanca de rodilla

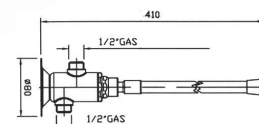

REF

PVP (€)

IDG03052

66

Pulsador temporizado 1 agua

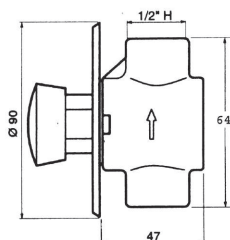

REF

PVP (€)

IDG03054

36

Escuadra mezcladora/reguladora agua caliente/fría

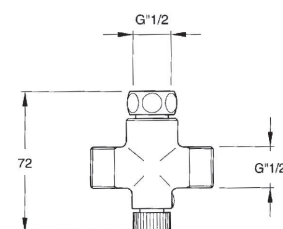

REF

PVP (€)

IDG03058

12

Válvula anti-retorno 1/2 conexión M/H



REF

PVP (€)

IDG03338

Tubo malla flexible 1000mm 1/2 conexión H/H

16

IDG03339

Tubo malla flexible 1000mm 1/2 conexión M/H

16





# 04.

## CAÑOS Y RECAMBIOS

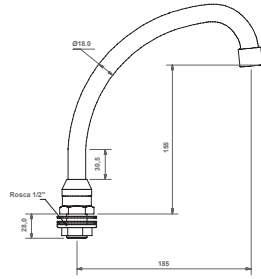

**REF** **PVP (€)**

IDG03001 **30**

Caño orientable económico

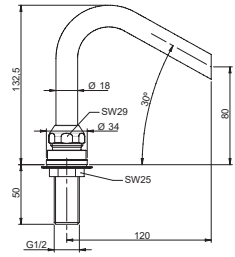

**REF** **PVP (€)**

IDG033010 **42**

Caño orientable pequeño

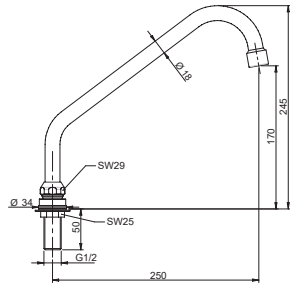

**REF** **PVP (€)**

IDG33020 **66**

Caño orientable mediano

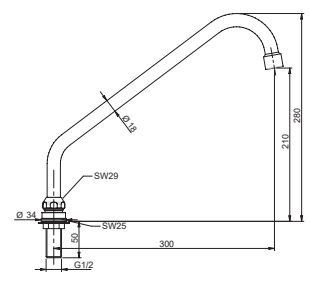

**REF** **PVP (€)**

IDG03330 **84**

Caño orientable grande



**REF** **PVP (€)**

IDG33331 **72**

Muelle inox para grifo ducha



**NUEVO MODELO**

**REF** **PVP (€)**

IDG33330 **84**

Cabezal grifo ducha G1/2



**REF** **PVP (€)**

Cartucho 1: IDG33361 **24**

Cartucho 2: IDG33362 **24**

Cartucho 3: IDG33363 **24**

Cartucho 4: IDG33364 **24**

Cartucho 5: IDG33365 **24**

Cartucho 6: IDG33366 **24**

Cartucho 7: IDG33367 **24**

**REF** **PVP (€)**

IDG33334 **32**  
Manguera flexible 400mm para grifo ducha

IDG33332 **36**  
Manguera flexible 1100mm para grifo ducha



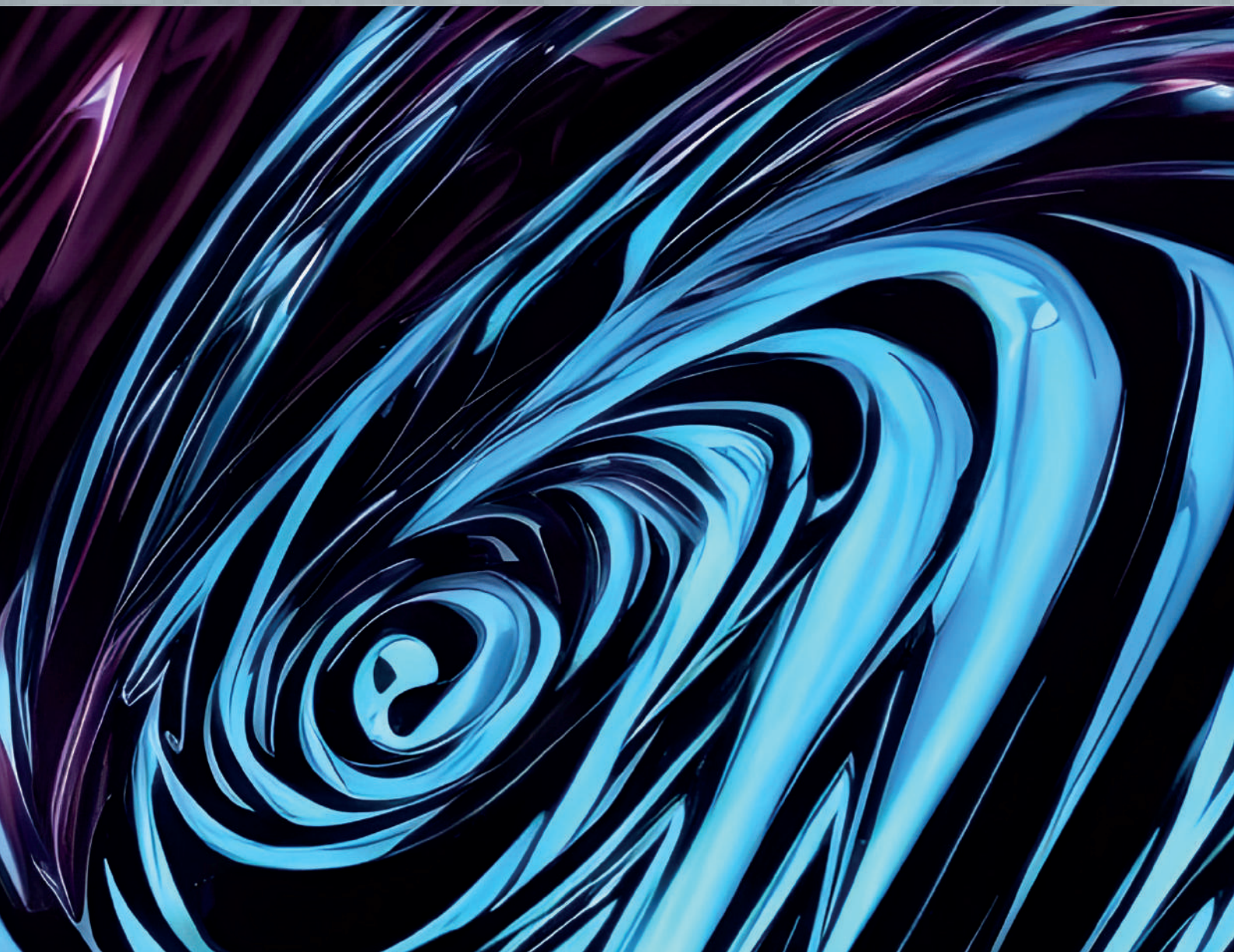



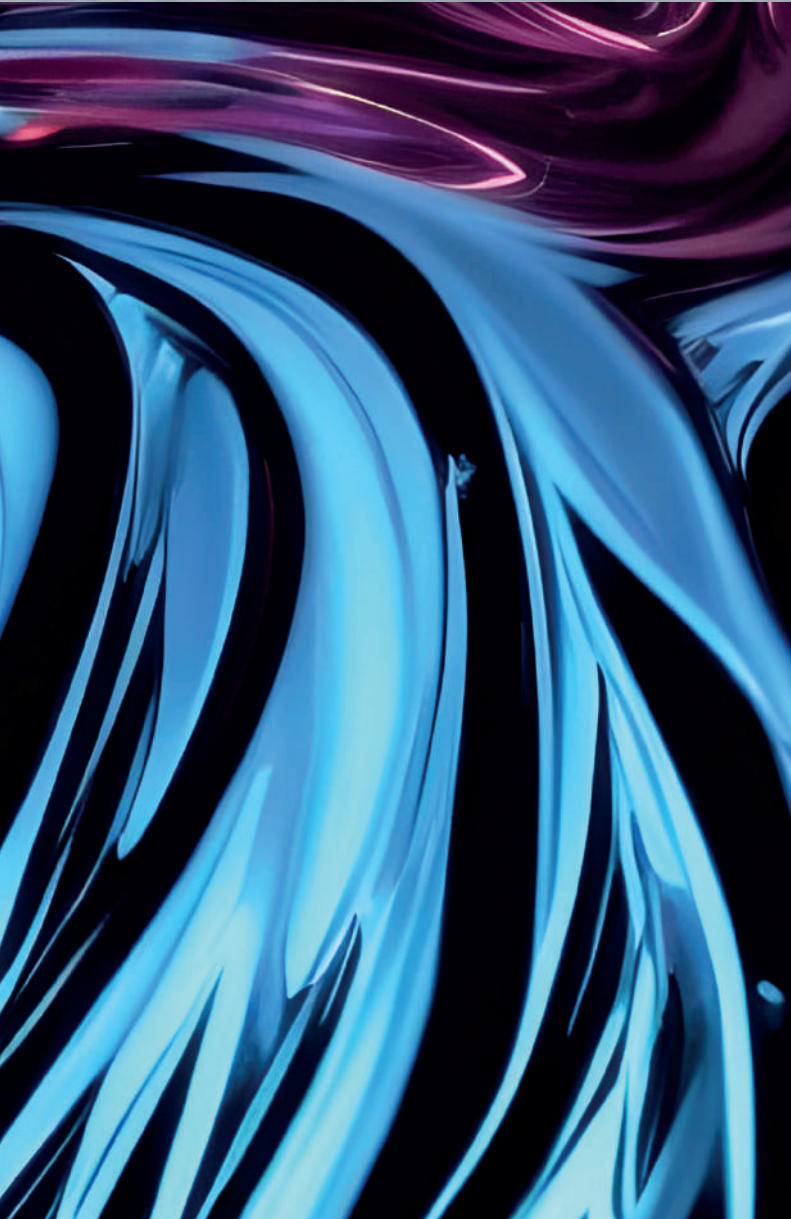

# 05.

- Cintas cordones
- Cintas tapiz
- Accesorios

## GAMA RENOVADA

## CINTAS CORDONES

- **Cordones** termosoldados.
- Motor-reductor con **velocidad regulable** 2.5-12m/min, sistema de paro automático.
- **Pulsador** emergencia incorporado.
- **Paragolpes** lateral de caucho.



DIM (mm)	CONSUMO / TENSIÓN	REF	PVP (€)
2000x500x850	330w 230v/50-60hz	IDLMC020	10219
2500x500x850	330w 230v/50-60hz	IDLMC025	10395
3000x500x850	330w 230v/50-60hz	IDLMC030	10560
3500x500x850	330w 230v/50-60hz	IDLMC035	10736
4000x500x850	330w 230v/50-60hz	IDLMC040	10962
4500x500x850	330w 230v/50-60hz	IDLMC045	11451
5000x500x850	330w 230v/50-60hz	IDLMC050	11688
5500x500x850	330w 230v/50-60hz	IDLMC055	11875
6000x500x850	330w 230v/50-60hz	IDLMC060	12111
6500x500x850	370w 230v/50-60hz	IDLMC065	12606
7000x500x850	370w 230v/50-60hz	IDLMC070	12859
7500x500x850	370w 230v/50-60hz	IDLMC075	13057
8000x500x850	370w 230v/50-60hz	IDLMC080	13360
8500x500x850	370w 230v/50-60hz	IDLMC085	13844
9000x500x850	370w 230v/50-60hz	IDLMC090	14201
9500x500x850	370w 230v/50-60hz	IDLMC095	14413
10000x500x850	370w 230v/50-60hz	IDLMC100	14630

## CINTA CORDONES ANGULAR

- **Cordones** termosoldados.
- Motor-reductor con **velocidad regulable** 2.5-12m/ min, sistema de paro automático.
- **Pulsador** emergencia incorporado.

DIM (mm)	CONSUMO / TENSIÓN	REF	PVP (€)
700x700x850	330w 230v/50-60hz	IDLMC003	4692



## ENCIMERA APOYO PLEGABLE

- **Cartelas** abatibles de acero inox.

DIM (mm)	REF.	PVP (€)
600x400x40mm	IDLMA005	429



# 05.

GAMA RENOVADA

## CINTAS TAPIZ

- **Tapiz** de poliuretano.
- Motor-reductor con **velocidad regulable** 2.5/12m/min, sistema de paro automático.
- **Pulsador** emergencia incorporado.
- **Paragolpes** lateral de caucho.



DIM (mm)	CONSUMO / TENSIÓN	REF	PVP (€)
2000x500x850	330w 230v/50-60hz	IDLMT020	<b>11022</b>
2500x500x850	330w 230v/50-60hz	IDLMT025	<b>11209</b>
3000x500x850	330w 230v/50-60hz	IDLMT030	<b>11363</b>
3500x500x850	330w 230v/50-60hz	IDLMT035	<b>11495</b>
4000x500x850	330w 230v/50-60hz	IDLMT040	<b>11677</b>
4500x500x850	330w 230v/50-60hz	IDLMT045	<b>12232</b>
5000x500x850	330w 230v/50-60hz	IDLMT050	<b>12381</b>
5500x500x850	330w 230v/50-60hz	IDLMT055	<b>12645</b>
6000x500x850	330w 230v/50-60hz	IDLMT060	<b>12936</b>
6500x500x850	370w 230v/50-60hz	IDLMT065	<b>13206</b>
7000x500x850	370w 230v/50-60hz	IDLMT070	<b>13415</b>
7500x500x850	370w 230v/50-60hz	IDLMT075	<b>13954</b>
8000x500x850	370w 230v/50-60hz	IDLMT080	<b>14185</b>
8500x500x850	370w 230v/50-60hz	IDLMT085	<b>14471</b>
9000x500x850	370w 230v/50-60hz	IDLMT090	<b>14619</b>
9500x500x850	370w 230v/50-60hz	IDLMT095	<b>14762</b>
10000x500x850	370w 230v/50-60hz	IDLMT100	<b>15065</b>

## ENCHUFE ADICIONAL

- Con **soporte** de acero inox para montar en cintas.

CARACTERÍSTICAS	REF	PVP (€)
230 V / 16A / 2P+T	IDLMA001	<b>176</b>



## ENCHUFE SCHUKO

- Con **soporte** de acero inox para montar en cintas.

CARACTERÍSTICAS	REF	PVP (€)
400V / 16A / 3P+N+T	IDLMA003	<b>165</b>



## PULSADOR EMERGENCIA

- Con **soporte** de acero inox para montar en cintas.

CARACTERÍSTICAS	REF	PVP (€)
230V	IDLMA004	<b>341</b>







# 06.

- Mesas desmontadas
- Mesas soldadas
- Mesas reciclaje
- Mesas preparación
- Encimeras
- Mesas angulares
- Pilonas de corte
- Mesas soporte con guías
- Soportes y cartelas
- Accesorios



## GAMA AMPLIADA

MESAS CENTRALES ESTÁNDAR  
DESMONTADAS

- **Reforzadas** con omegas.
- **Frontal** soldado de 60mm en punto redondo.
- **Estante** reforzado con omega central.
- **Patas** de tubo 40x40 con taco regulable 60mm, 6 patas a partir de 2000mm.

Mesas soldadas consultar páginas 70-71.



Se suministran desmontadas  
Rápido y fácil montaje.

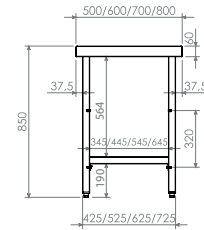

## Marco refuerzo h850

LARGO	FONDO 500	PVP (€)	FONDO 600	PVP (€)	FONDO 700	PVP (€)	FONDO 800	PVP (€)
600	IDC5006D	403	IDC6006D	443	IDC7006D	454	IDC8006D	497
800	IDC5008D	420	IDC6008D	460	IDC7008D	472	IDC8008D	510
1000	IDC5010D	437	IDC6010D	477	IDC7010D	489	IDC8010D	528
1200	IDC5012D	460	IDC6012D	500	IDC7012D	512	IDC8012D	558
1400	IDC5014D	495	IDC6014D	535	IDC7014D	546	IDC8014D	594
1500	IDC5015D	518	IDC6015D	558	IDC7015D	569	IDC8015D	625
1600	IDC5016D	541	IDC6016D	581	IDC7016D	592	IDC8016D	649
1800	IDC5018D	610	IDC6018D	650	IDC7018D	661	IDC8018D	740
2000	IDC5020D	633	IDC6020D	684	IDC7020D	702	IDC8020D	801
2200	IDC5022D	742	IDC6022D	811	IDC7022D	828	IDC8022D	922
2400	IDC5024D	782	IDC6024D	834	IDC7024D	851	IDC8024D	971

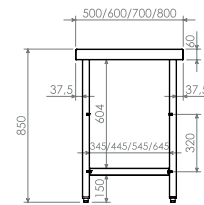

## 1 Estante inferior h850

LARGO	FONDO 500	PVP (€)	FONDO 600	PVP (€)	FONDO 700	PVP (€)	FONDO 800	PVP (€)
600	IDC5106D	431	IDC6106D	460	IDC7106D	472	IDC8106D	510
800	IDC5108D	449	IDC6108D	477	IDC7108D	500	IDC8108D	528
1000	IDC5110D	466	IDC6110D	495	IDC7110D	512	IDC8110D	552
1200	IDC5112D	489	IDC6112D	518	IDC7112D	529	IDC8112D	582
1400	IDC5114D	523	IDC6114D	552	IDC7114D	575	IDC8114D	631
1500	IDC5115D	546	IDC6115D	575	IDC7115D	610	IDC8115D	655
1600	IDC5116D	581	IDC6116D	598	IDC7116D	633	IDC8116D	685
1800	IDC5118D	638	IDC6118D	667	IDC7118D	725	IDC8118D	770
2000	IDC5120D	667	IDC6120D	707	IDC7120D	753	IDC8120D	837
2200	IDC5122D	782	IDC6122D	834	IDC7122D	857	IDC8122D	946
2400	IDC5124D	822	IDC6124D	857	IDC7124D	880	IDC8124D	1007

## Estante adicional



LARGO	FONDO 500	PVP (€)	FONDO 600	PVP (€)	FONDO 700	PVP (€)	FONDO 800	PVP (€)
600	IDP5906D	132	IDP6906D	144	IDP7906D	155	IDP8906D	173
800	IDP5908D	138	IDP6908D	150	IDP7908D	161	IDP8908D	178
1000	IDP5910D	144	IDP6910D	155	IDP7910D	167	IDP8910D	184
1200	IDP5912D	155	IDP6912D	167	IDP7912D	178	IDP8912D	201
1400	IDP5914D	173	IDP6914D	190	IDP7914D	201	IDP8914D	224
1500	IDP5915D	190	IDP6915D	207	IDP7915D	219	IDP8915D	247
1600	IDP5916D	201	IDP6916D	224	IDP7916D	236	IDP8916D	265
1800	IDP5918D	219	IDP6918D	242	IDP7918D	253	IDP8918D	288
2000	IDP5920D	236	IDP6920D	259	IDP7920D	270	IDP8920D	305
2200	IDP5922D	253	IDP6922D	276	IDP7922D	288	IDP8922D	328
2400	IDP5924D	270	IDP6924D	293	IDP7924D	305	IDP8924D	351

## Marco refuerzo h600

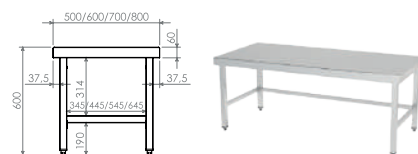

LARGO	FONDO 500	PVP (€)	FONDO 600	PVP (€)	FONDO 700	PVP (€)	FONDO 800	PVP (€)
600	IDC5706D	403	IDC6706D	443	IDC7706D	454	IDC8706D	497
800	IDC5708D	420	IDC6708D	460	IDC7708D	472	IDC8708D	510
1000	IDC5710D	437	IDC6710D	477	IDC7710D	489	IDC8710D	528
1200	IDC5712D	460	IDC6712D	500	IDC7712D	512	IDC8712D	558
1400	IDC5714D	495	IDC6714D	535	IDC7714D	546	IDC8714D	594
1500	IDC5715D	518	IDC6715D	558	IDC7715D	569	IDC8715D	625
1600	IDC5716D	541	IDC6716D	581	IDC7716D	592	IDC8716D	649
1800	IDC5718D	610	IDC6718D	650	IDC7718D	661	IDC8718D	740
2000	IDC5720D	633	IDC6720D	684	IDC7720D	702	IDC8720D	801
2200	IDC5722D	742	IDC6722D	811	IDC7722D	828	IDC8722D	922
2400	IDC5724D	782	IDC6724D	834	IDC7724D	851	IDC8724D	971

## 1 Estante inferior h600

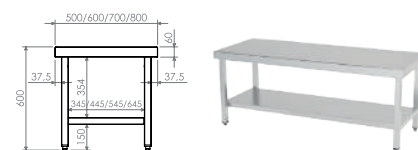

LARGO	FONDO 500	PVP (€)	FONDO 600	PVP (€)	FONDO 700	PVP (€)	FONDO 800	PVP (€)
600	IDC5506D	431	IDC6506D	460	IDC7506D	472	IDC8506D	510
800	IDC5508D	449	IDC6508D	477	IDC7508D	489	IDC8508D	528
1000	IDC5510D	466	IDC6510D	495	IDC7510D	512	IDC8510D	552
1200	IDC5512D	489	IDC6512D	518	IDC7512D	529	IDC8512D	582
1400	IDC5514D	523	IDC6514D	552	IDC7514D	575	IDC8514D	631
1500	IDC5515D	546	IDC6515D	575	IDC7515D	610	IDC8515D	655
1600	IDC5516D	581	IDC6516D	598	IDC7516D	633	IDC8516D	685
1800	IDC5518D	638	IDC6518D	667	IDC7518D	725	IDC8518D	770
2000	IDC5520D	667	IDC6520D	707	IDC7520D	753	IDC8520D	837
2200	IDC5522D	782	IDC6522D	834	IDC7522D	857	IDC8522D	946
2400	IDC5524D	822	IDC6524D	857	IDC7524D	880	IDC8524D	1007



## GAMA AMPLIADA

MESAS MURALES ESTÁNDAR  
DESMONTADAS

- **Reforzadas** con omegas.
- **Frontal** soldado de 60mm en punto redondo, **peto** posterior soldado de 100mm con radio sanitario.
- **Estante** reforzado con omega central.
- **Patas** de tubo 40x40 con taco regulable 60mm, 6 patas a partir de 2000mm.

Mesas soldadas consultar páginas 72-73.



Se suministran desmontadas  
Rápido y fácil montaje.

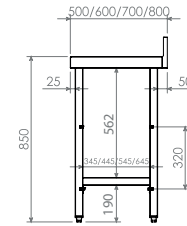

## Marco refuerzo h850

LARGO	FONDO 500	PVP (€)	FONDO 600	PVP (€)	FONDO 700	PVP (€)	FONDO 800	PVP (€)
600	IDM5006D	427	IDM6006D	449	IDM7006D	472	IDM8006D	506
800	IDM5008D	444	IDM6008D	472	IDM7008D	483	IDM8008D	523
1000	IDM5010D	461	IDM6010D	489	IDM7010D	500	IDM8010D	564
1200	IDM5012D	483	IDM6012D	518	IDM7012D	529	IDM8012D	587
1400	IDM5014D	516	IDM6014D	552	IDM7014D	564	IDM8014D	679
1500	IDM5015D	538	IDM6015D	575	IDM7015D	592	IDM7015D	696
1600	IDM5016D	560	IDM6016D	598	IDM7016D	615	IDM7016D	713
1800	IDM5018D	627	IDM6018D	684	IDM7018D	702	IDM7018D	805
2000	IDM5020D	660	IDM6020D	713	IDM7020D	759	IDM7020D	840
2200	IDM5022D	782	IDM6022D	828	IDM7022D	874	IDM7022D	966
2400	IDM5024D	805	IDM6024D	886	IDM7024D	920	IDM7024D	1001

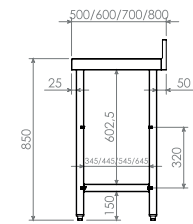

## 1 Estante inferior h850

LARGO	FONDO 500	PVP (€)	FONDO 600	PVP (€)	FONDO 700	PVP (€)	FONDO 800	PVP (€)
600	IDM5106D	444	IDM6106D	477	IDM7106D	483	IDM8106D	535
800	IDM5108D	461	IDM6108D	489	IDM7108D	500	IDM8108D	564
1000	IDM5110D	477	IDM6110D	500	IDM7110D	523	IDM8110D	604
1200	IDM5112D	499	IDM6112D	529	IDM7112D	552	IDM8112D	633
1400	IDM5114D	533	IDM6114D	564	IDM7114D	598	IDM8114D	719
1500	IDM5115D	555	IDM6115D	587	IDM7115D	621	IDM8115D	736
1600	IDM5116D	577	IDM6116D	610	IDM7116D	650	IDM8116D	753
1800	IDM5118D	644	IDM6118D	696	IDM7118D	730	IDM8118D	874
2000	IDM5120D	682	IDM6120D	725	IDM7120D	794	IDM8120D	897
2200	IDM5122D	805	IDM6122D	863	IDM7122D	897	IDM8122D	1006
2400	IDM5124D	827	IDM6124D	920	IDM7124D	955	IDM8124D	1035



## Estante adicional



LARGO	FONDO 500	PVP (€)	FONDO 600	PVP (€)	FONDO 700	PVP (€)	FONDO 800	PVP (€)
600	IDP5906D	132	IDP6906D	144	IDP7906D	155	IDP8906D	173
800	IDP5908D	138	IDP6908D	150	IDP7908D	161	IDP8908D	178
1000	IDP5910D	144	IDP6910D	155	IDP7910D	167	IDP8910D	184
1200	IDP5912D	155	IDP6912D	167	IDP7912D	178	IDP8912D	201
1400	IDP5914D	173	IDP6914D	190	IDP7914D	201	IDP8914D	224
1500	IDP5915D	190	IDP6915D	207	IDP7915D	219	IDP8915D	247
1600	IDP5916D	201	IDP6916D	224	IDP7916D	236	IDP8916D	265
1800	IDP5918D	219	IDP6918D	242	IDP7918D	253	IDP8918D	288
2000	IDP5920D	236	IDP6920D	259	IDP7920D	270	IDP8920D	305
2200	IDP5922D	253	IDP6922D	276	IDP7922D	288	IDP8922D	328
2400	IDP5924D	270	IDP6924D	293	IDP7924D	305	IDP8924D	351

## Marco refuerzo h600

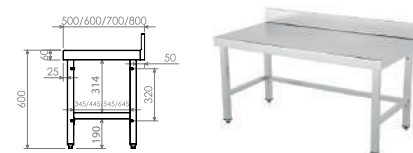

LARGO	FONDO 500	PVP (€)	FONDO 600	PVP (€)	FONDO 700	PVP (€)	FONDO 800	PVP (€)
600	IDM5806D	427	IDM6806D	449	IDM7806D	472	IDM8806D	506
800	IDM5808D	444	IDM6808D	472	IDM7808D	483	IDM8808D	523
1000	IDM5810D	461	IDM6810D	489	IDM7810D	500	IDM8810D	564
1200	IDM5812D	483	IDM6812D	518	IDM7812D	529	IDM8812D	587
1400	IDM5814D	516	IDM6814D	552	IDM7814D	564	IDM8814D	679
1500	IDM5815D	538	IDM6815D	575	IDM7815D	592	IDM8815D	696
1600	IDM5816D	560	IDM6816D	598	IDM7816D	615	IDM8816D	713
1800	IDM5818D	627	IDM6818D	684	IDM7818D	702	IDM8818D	805
2000	IDM5820D	660	IDM6820D	713	IDM7820D	759	IDM8820D	840
2200	IDM5822D	782	IDM6822D	828	IDM7822D	874	IDM8822D	966
2400	IDM5824D	805	IDM6824D	886	IDM7824D	920	IDM8824D	1001

## 1 Estante inferior h600

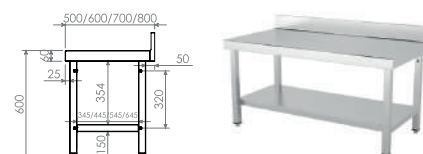

LARGO	FONDO 500	PVP (€)	FONDO 600	PVP (€)	FONDO 700	PVP (€)	FONDO 800	PVP (€)
600	IDM5606D	444	IDM6606D	477	IDM7606D	483	IDM8606D	535
800	IDM5608D	461	IDM6608D	489	IDM7608D	500	IDM8608D	564
1000	IDM5610D	477	IDM6610D	500	IDM7610D	523	IDM8610D	604
1200	IDM5612D	499	IDM6612D	529	IDM7612D	552	IDM8612D	633
1400	IDM5614D	533	IDM6614D	564	IDM7614D	598	IDM8614D	719
1500	IDM5615D	555	IDM6615D	587	IDM7615D	621	IDM8615D	736
1600	IDM5616D	577	IDM6616D	610	IDM7616D	650	IDM8616D	753
1800	IDM5618D	644	IDM6618D	696	IDM7618D	730	IDM8618D	863
2000	IDM5620D	682	IDM6620D	725	IDM7620D	794	IDM8620D	897
2200	IDM5622D	805	IDM6622D	863	IDM7622D	897	IDM8622D	1006
2400	IDM5624D	827	IDM6624D	920	IDM7624D	955	IDM8624D	1035

## MESAS MURALES CHEF ESTÁNDAR DESMONTADAS MARCO REFUERZO

06.

- **Reforzadas** con omegas.
- **Frontal** soldado de 60mm en punto redondo, **peto** posterior soldado de 100mm con radio sanitario.
- **Cuba** soldada 400x340x200mm en mesas fondo 500mm. Cuba soldada 400x400x200mm en mesas fondo 600mm y 700mm.
- **Estante** reforzado con omega central.
- **Patas** de tubo 40x40 con taco regulable 60mm, 6 patas a partir de 2000mm.

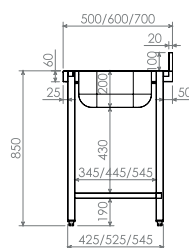

Se suministran desmontadas  
Rápido y fácil montaje.



Mesas soldadas consultar página 74.



Cuba derecha



Cuba izquierda



Cuba central



### Fondo 500

DIM (mm)	CUBA DCHA.	PVP (€)	CUBA IZQ.	PVP (€)
1200x500x850	IDX5012D	627	IDX5012I	627
1500x500x850	IDX5015D	702	IDX5015I	702
1800x500x850	IDX5018D	782	IDX5018I	782

### Fondo 600

DIM (mm)	CUBA DCHA.	PVP (€)	CUBA IZQ.	PVP (€)	CUBA CENT.	PVP (€)
1000x600x850	IDX6010D	592	IDX6010I	592		
1200x600x850	IDX6012D	621	IDX6012I	621		
1400x600x850	IDX6014D	679	IDX6014I	679		
1500x600x850	IDX6015D	696	IDX6015I	696		
1600x600x850	IDX6016D	736	IDX6016I	736	IDX6016C	765
1800x600x850	IDX6018D	776	IDX6018I	776	IDX6018C	805
2000x600x850	IDX6020D	828	IDX6020I	828	IDX6020C	874

### Fondo 700

DIM (mm)	CUBA DCHA.	PVP (€)	CUBA IZQ.	PVP (€)	CUBA CENT.	PVP (€)
1000x700x850	IDX7010D	690	IDX7010I	690		
1200x700x850	IDX7012D	730	IDX7012I	730		
1400x700x850	IDX7014D	776	IDX7014I	776		
1500x700x850	IDX7015D	805	IDX7015I	805		
1600x700x850	IDX7016D	840	IDX7016I	840	IDX7016C	891
1800x700x850	IDX7018D	920	IDX7018I	920	IDX7018C	966
2000x700x850	IDX7020D	966	IDX7020I	966	IDX7020C	1024



**Se suministran desmontadas**  
Rápido y fácil montaje.

Mesas soldadas consultar página 75.

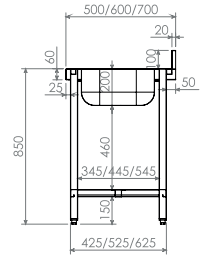

Cuba derecha



Cuba izquierda



Cuba central

## Fondo 500

DIM (mm)	CUBA DCHA.	PVP (€)	CUBA IZQ.	PVP (€)
1200x500x850	IDX5112D	<b>690</b>	IDX5112I	<b>690</b>
1500x500x850	IDX5115D	<b>771</b>	IDX5115I	<b>771</b>
1800x500x850	IDX5118D	<b>845</b>	IDX5118I	<b>845</b>

## Fondo 600

DIM (mm)	CUBA DCHA.	PVP (€)	CUBA IZQ.	PVP (€)	CUBA CENT.	PVP (€)
1000x600x850	IDX6110D	<b>707</b>	IDX6110I	<b>707</b>		
1200x600x850	IDX6112D	<b>736</b>	IDX6112I	<b>736</b>		
1400x600x850	IDX6114D	<b>771</b>	IDX6114I	<b>771</b>		
1500x600x850	IDX6115D	<b>788</b>	IDX6115I	<b>788</b>		
1600x600x850	IDX6116D	<b>822</b>	IDX6116I	<b>822</b>	IDX6116C	<b>840</b>
1800x600x850	IDX6118D	<b>863</b>	IDX6118I	<b>863</b>	IDX6118C	<b>874</b>
2000x600x850	IDX6120D	<b>949</b>	IDX6120I	<b>949</b>	IDX6120C	<b>972</b>

## Fondo 700

DIM (mm)	CUBA DCHA.	PVP (€)	CUBA IZQ.	PVP (€)	CUBA CENT.	PVP (€)
1000x700x850	IDX7110D	<b>776</b>	IDX7110I	<b>776</b>		
1200x700x850	IDX7112D	<b>817</b>	IDX7112I	<b>817</b>		
1400x700x850	IDX7114D	<b>851</b>	IDX7114I	<b>851</b>		
1500x700x850	IDX7115D	<b>868</b>	IDX7115I	<b>868</b>		
1600x700x850	IDX7116D	<b>891</b>	IDX7116I	<b>891</b>	IDX7116C	<b>914</b>
1800x700x850	IDX7118D	<b>949</b>	IDX7118I	<b>949</b>	IDX7118C	<b>966</b>
2000x700x850	IDX7120D	<b>1012</b>	IDX7120I	<b>1012</b>	IDX7120C	<b>1041</b>

## GAMA AMPLIADA

MESAS CENTRALES ESTÁNDAR  
SOLDADAS

- **Reforzadas** con omegas.
- **Frontal** soldado de 60mm en punto redondo.
- **Estante** reforzado con omega central.
- **Patas** de tubo 40x40 con taco regulable 60mm, 6 patas a partir de 2000mm.

Mesas desmontadas consultar páginas 64-65.

Medidas especiales en gama flexi estándar página 202.



**Totalmente soldadas**  
Se suministran montadas y soldadas.



## Marco refuerzo h850

LARGO	FONDO 500	PVP (€)	FONDO 600	PVP (€)	FONDO 700	PVP (€)	FONDO 800	PVP (€)
600	IDC05006	461	IDC06006	477	IDC07006	489	IDC08006	546
800	IDC05008	477	IDC06008	495	IDC07008	506	IDC08008	575
1000	IDC05010	494	IDC06010	512	IDC07010	535	IDC08010	615
1200	IDC05012	516	IDC06012	535	IDC07012	558	IDC08012	650
1400	IDC05014	549	IDC06014	569	IDC07014	644	IDC08014	730
1500	IDC05015	572	IDC06015	592	IDC07015	661	IDC08015	748
1600	IDC05016	594	IDC06016	615	IDC07016	679	IDC08016	765
1800	IDC05018	660	IDC06018	684	IDC07018	771	IDC08018	886
2000	IDC05020	694	IDC06020	719	IDC07020	794	IDC08020	903
2200	IDC05022	816	IDC06022	845	IDC07022	897	IDC08022	1029
2400	IDC05024	838	IDC06024	868	IDC07024	926	IDC08024	1064

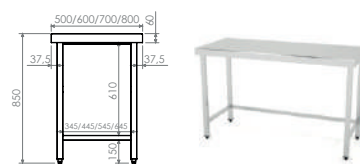

## 1 Estante inferior h850

LARGO	FONDO 500	PVP (€)	FONDO 600	PVP (€)	FONDO 700	PVP (€)	FONDO 800	PVP (€)
600	IDC05106	488	IDC06106	506	IDC07106	518	IDC08106	575
800	IDC05108	505	IDC06108	523	IDC07108	535	IDC08108	604
1000	IDC05110	522	IDC06110	541	IDC07110	564	IDC08110	644
1200	IDC05112	544	IDC06112	564	IDC07112	587	IDC08112	667
1400	IDC05114	577	IDC06114	598	IDC07114	673	IDC08114	759
1500	IDC05115	599	IDC06115	621	IDC07115	690	IDC08115	776
1600	IDC05116	621	IDC06116	644	IDC07116	707	IDC08116	794
1800	IDC05118	688	IDC06118	713	IDC07118	799	IDC08118	914
2000	IDC05120	727	IDC06120	753	IDC07120	828	IDC08120	943
2200	IDC05122	849	IDC06122	880	IDC07122	932	IDC08122	1075
2400	IDC05124	871	IDC06124	903	IDC07124	960	IDC08124	1110

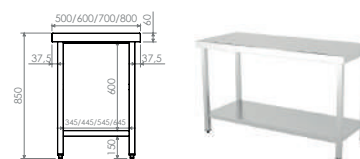

## 2 Estantes inferiores h850

LARGO	FONDO 500	PVP (€)	FONDO 600	PVP (€)	FONDO 700	PVP (€)	FONDO 800	PVP (€)
600	IDC05206	618	IDC06206	644	IDC07206	667	IDC08206	742
800	IDC05208	640	IDC06208	667	IDC07208	690	IDC08208	776
1000	IDC05210	662	IDC06210	690	IDC07210	725	IDC08210	822
1200	IDC05212	696	IDC06212	725	IDC07212	759	IDC08212	863
1400	IDC05214	751	IDC06214	782	IDC07214	868	IDC08214	978
1500	IDC05215	789	IDC06215	822	IDC07215	903	IDC08215	1018
1600	IDC05216	828	IDC06216	863	IDC07216	937	IDC08216	1052
1800	IDC05218	911	IDC06218	949	IDC07218	1064	IDC08218	1208
2000	IDC05220	966	IDC06220	1006	IDC07220	1104	IDC08220	1254
2200	IDC05222	1110	IDC06222	1156	IDC07222	1225	IDC08222	1409
2400	IDC05224	1137	IDC06224	1185	IDC07224	1271	IDC08224	1466

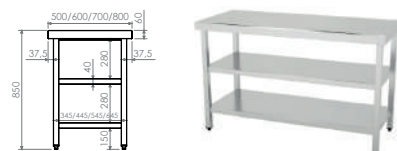

## Marco refuerzo h600

LARGO	FONDO 500	PVP (€)	FONDO 600	PVP (€)	FONDO 700	PVP (€)	FONDO 800	PVP (€)
600	IDC50506	461	IDC60506	477	IDC70506	489	IDC80506	546
800	IDC50508	477	IDC60508	495	IDC70508	506	IDC80508	575
1000	IDC50510	494	IDC60510	512	IDC70510	535	IDC80510	615
1200	IDC50512	516	IDC60512	535	IDC70512	558	IDC80512	650
1400	IDC50514	549	IDC60514	569	IDC70514	644	IDC80514	730
1500	IDC50515	572	IDC60515	592	IDC70515	661	IDC80515	748
1600	IDC50516	594	IDC60516	615	IDC70516	679	IDC80516	765
1800	IDC50518	660	IDC60518	684	IDC70518	771	IDC80518	886
2000	IDC50520	694	IDC60520	719	IDC70520	794	IDC80520	903
2200	IDC50522	816	IDC60522	845	IDC70522	897	IDC80522	1029
2400	IDC50524	838	IDC60524	868	IDC70524	926	IDC80524	1064

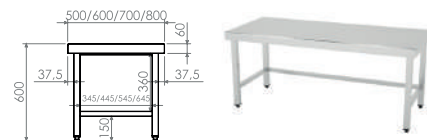

## 1 Estante inferior h600

LARGO	FONDO 500	PVP (€)	FONDO 600	PVP (€)	FONDO 700	PVP (€)	FONDO 800	PVP (€)
600	IDC51506	488	IDC61506	506	IDC71506	518	IDC81506	575
800	IDC51508	505	IDC61508	523	IDC71508	535	IDC81508	604
1000	IDC51510	522	IDC61510	541	IDC71510	564	IDC81510	644
1200	IDC51512	544	IDC61512	564	IDC71512	587	IDC81512	667
1400	IDC51514	577	IDC61514	598	IDC71514	673	IDC81514	759
1500	IDC51515	599	IDC61515	621	IDC71515	690	IDC81515	776
1600	IDC51516	621	IDC61516	644	IDC71516	707	IDC81516	794
1800	IDC51518	688	IDC61518	713	IDC71518	799	IDC81518	914
2000	IDC51520	727	IDC61520	753	IDC71520	828	IDC81520	943
2200	IDC51522	849	IDC61522	880	IDC71522	932	IDC81522	1075
2400	IDC51524	871	IDC61524	903	IDC71524	960	IDC81524	1110

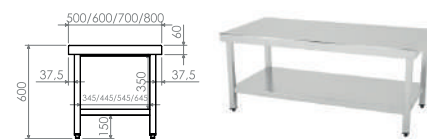



## GAMA AMPLIADA

MESAS MURALES ESTÁNDAR  
SOLDADAS

- **Reforzadas** con omegas.
- **Frontal** soldado de 60mm en punto redondo, **peto** posterior de 100mm con radio sanitario.
- **Estante** reforzado con omega central.
- **Patas** de tubo 40x40 con taco regulable 60mm, 6 patas a partir de 2000mm.

Mesas desmontadas consultar páginas 66-67.

Medidas especiales en gama flexi estándar página 203.



**Totalmente soldadas**  
Se suministran montadas y soldadas.

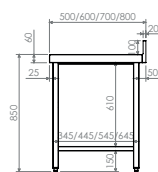

## Marco refuerzo h850

LARGO	FONDO 500	PVP (€)	FONDO 600	PVP (€)	FONDO 700	PVP (€)	FONDO 800	PVP (€)
600	IDM50006	466	IDM60006	489	IDM70006	506	IDM80006	582
800	IDM50008	483	IDM60008	512	IDM70008	541	IDM80008	622
1000	IDM50010	500	IDM60010	529	IDM70010	558	IDM70010	641
1200	IDM50012	523	IDM60012	558	IDM70012	592	IDM70012	681
1400	IDM50014	558	IDM60014	575	IDM70014	673	IDM70014	774
1500	IDM50015	581	IDM60015	604	IDM70015	696	IDM70015	800
1600	IDM50016	604	IDM60016	621	IDM70016	719	IDM70016	827
1800	IDM50018	673	IDM60018	725	IDM70018	799	IDM70018	919
2000	IDM50020	696	IDM60020	748	IDM70020	834	IDM70020	959
2200	IDM50022	805	IDM60022	886	IDM70022	932	IDM70022	1071
2400	IDM50024	845	IDM60024	914	IDM70024	960	IDM70024	1104

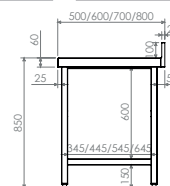

## 1 Estante inferior h850

LARGO	FONDO 500	PVP (€)	FONDO 600	PVP (€)	FONDO 700	PVP (€)	FONDO 800	PVP (€)
600	IDM51006	495	IDM61006	518	IDM71006	535	IDM81006	615
800	IDM51008	512	IDM61008	541	IDM71008	569	IDM81008	655
1000	IDM51010	529	IDM61010	558	IDM71010	587	IDM81010	674
1200	IDM51012	552	IDM61012	587	IDM71012	621	IDM81012	714
1400	IDM51014	587	IDM61014	615	IDM71014	702	IDM81014	807
1500	IDM51015	610	IDM61015	633	IDM71015	725	IDM81015	833
1600	IDM51016	644	IDM61016	650	IDM71016	748	IDM81016	860
1800	IDM51018	702	IDM61018	753	IDM71018	828	IDM81018	952
2000	IDM51020	730	IDM61020	782	IDM71020	868	IDM81020	998
2200	IDM51022	845	IDM61022	949	IDM71022	989	IDM81022	1137
2400	IDM51024	886	IDM61024	972	IDM71024	1012	IDM81024	1164

## 2 Estantes inferiores h850

LARGO	FONDO 500	PVP (€)	FONDO 600	PVP (€)	FONDO 700	PVP (€)	FONDO 800	PVP (€)
600	IDM52006	629	IDM62006	656	IDM72006	684	IDM82006	798
800	IDM52008	657	IDM62008	684	IDM72008	725	IDM82008	833
1000	IDM52010	679	IDM62010	707	IDM72010	748	IDM82010	860
1200	IDM52012	718	IDM62012	748	IDM72012	794	IDM82012	913
1400	IDM52014	767	IDM62014	799	IDM72014	897	IDM82014	1032
1500	IDM52015	800	IDM62015	834	IDM72015	937	IDM82015	1078
1600	IDM52016	834	IDM62016	868	IDM72016	978	IDM82016	1124
1800	IDM52018	949	IDM62018	989	IDM72018	1087	IDM82018	1250
2000	IDM52020	1005	IDM62020	1047	IDM72020	1144	IDM82020	1316
2200	IDM52022	1181	IDM62022	1231	IDM72022	1271	IDM82022	1461
2400	IDM52024	1220	IDM62024	1271	IDM72024	1323	IDM82024	1521

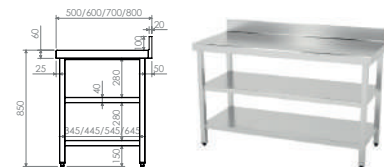

## Marco refuerzo h600

LARGO	FONDO 500	PVP (€)	FONDO 600	PVP (€)	FONDO 700	PVP (€)	FONDO 800	PVP (€)
600	IDM50506	466	IDM60506	489	IDM70506	506	IDM80506	582
800	IDM50508	483	IDM60508	512	IDM70508	541	IDM80508	622
1000	IDM50510	500	IDM60510	529	IDM70510	558	IDM80510	641
1200	IDM50512	523	IDM60512	558	IDM70512	592	IDM80512	681
1400	IDM50514	558	IDM60514	575	IDM70514	673	IDM80514	774
1500	IDM50515	581	IDM60515	604	IDM70515	696	IDM80515	800
1600	IDM50516	604	IDM60516	621	IDM70516	719	IDM80516	827
1800	IDM50518	673	IDM60518	725	IDM70518	799	IDM80518	919
2000	IDM50520	696	IDM60520	748	IDM70520	834	IDM80520	959
2200	IDM50522	805	IDM60522	886	IDM70522	932	IDM80522	1071
2400	IDM50524	845	IDM60524	914	IDM70524	960	IDM80524	1104

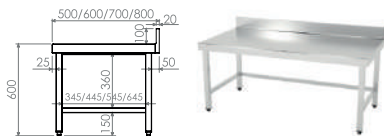

## 1 Estante inferior h600

LARGO	FONDO 500	PVP (€)	FONDO 600	PVP (€)	FONDO 700	PVP (€)	FONDO 800	PVP (€)
600	IDM51506	495	IDM61506	518	IDM71506	535	IDM81506	615
800	IDM51508	512	IDM61508	541	IDM71508	569	IDM81508	655
1000	IDM51510	529	IDM61510	558	IDM71510	587	IDM81510	674
1200	IDM51512	552	IDM61512	587	IDM71512	621	IDM81512	714
1400	IDM51514	587	IDM61514	615	IDM71514	702	IDM81514	807
1500	IDM51515	610	IDM61515	633	IDM71515	725	IDM81515	833
1600	IDM51516	644	IDM61516	650	IDM71516	748	IDM81516	860
1800	IDM51518	702	IDM61518	753	IDM71518	828	IDM81518	952
2000	IDM51520	730	IDM61520	782	IDM71520	868	IDM81520	998
2200	IDM51522	845	IDM61522	949	IDM71522	989	IDM81522	1137
2400	IDM51524	886	IDM61524	972	IDM71524	1012	IDM81524	1164

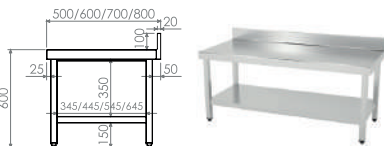

## MESAS MURALES CHEF ESTÁNDAR SOLDADAS MARCO REFUERZO

06.

- **Reforzadas** con omegas.
- **Frontal** soldado de 60mm en punto redondo y **peto** posterior soldado de 100mm con radio sanitario.
- **Cuba** soldada 400x340x200mm en mesas fondo 500mm. Cuba soldada 400x400x200mm en mesas fondo 600mm y 700mm.
- **Estante** reforzado con omega central.
- **Patas** de tubo 40x40 con taco regulable de 60mm.

**Totalmente soldadas**  
Se suministran montadas y soldadas.

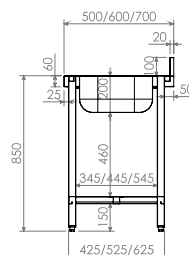

Mesas desmontadas consultar página 68.



Cuba derecha



Cuba izquierda



Cuba central

### Fondo 500

DIM (mm)	CUBA DCHA.	PVP (€)	CUBA IZQ.	PVP (€)
1200x500x850	IDX5812D	<b>633</b>	IDX5812I	<b>633</b>
1500x500x850	IDX5815D	<b>707</b>	IDX5815I	<b>707</b>
1800x500x850	IDX5818D	<b>788</b>	IDX5818I	<b>788</b>

### Fondo 600

DIM (mm)	CUBA DCHA.	PVP (€)	CUBA IZQ.	PVP (€)	CUBA CENT.	PVP (€)
1000x600x850	IDX6810D	<b>621</b>	IDX6810I	<b>621</b>		
1200x600x850	IDX6812D	<b>650</b>	IDX6812I	<b>650</b>		
1400x600x850	IDX6814D	<b>707</b>	IDX6814I	<b>707</b>		
1500x600x850	IDX6815D	<b>725</b>	IDX6815I	<b>725</b>		
1600x600x850	IDX6816D	<b>765</b>	IDX6816I	<b>765</b>	IDX6816C	<b>771</b>
1800x600x850	IDX6818D	<b>805</b>	IDX6818I	<b>805</b>	IDX6818C	<b>811</b>
2000x600x850	IDX6820D	<b>868</b>	IDX6820I	<b>868</b>	IDX6820C	<b>880</b>

### Fondo 700

DIM (mm)	CUBA DCHA.	PVP (€)	CUBA IZQ.	PVP (€)	CUBA CENT.	PVP (€)
1000x700x850	IDX7810D	<b>673</b>	IDX7810I	<b>673</b>		
1200x700x850	IDX7812D	<b>713</b>	IDX7812I	<b>713</b>		
1400x700x850	IDX7814D	<b>788</b>	IDX7814I	<b>788</b>		
1500x700x850	IDX7815D	<b>834</b>	IDX7815I	<b>834</b>		
1600x700x850	IDX7816D	<b>874</b>	IDX7816I	<b>874</b>	IDX7816C	<b>897</b>
1800x700x850	IDX7818D	<b>949</b>	IDX7818I	<b>949</b>	IDX7818C	<b>972</b>
2000x700x850	IDX7820D	<b>995</b>	IDX7820I	<b>995</b>	IDX7820C	<b>1029</b>



**Totalmente soldadas**  
Se suministran montadas y soldadas.

Mesas desmontadas consultar página 69.



Cuba derecha



Cuba izquierda



Cuba central

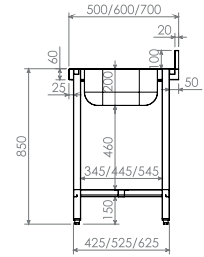

### Fondo 500

DIM (mm)	CUBA DCHA.	PVP (€)	CUBA IZQ.	PVP (€)
1200x500x850	IDX5912D	<b>696</b>	IDX5912I	<b>696</b>
1500x500x850	IDX5915D	<b>776</b>	IDX5915I	<b>776</b>
1800x500x850	IDX5918D	<b>851</b>	IDX5918I	<b>851</b>

### Fondo 600

DIM (mm)	CUBA DCHA.	PVP (€)	CUBA IZQ.	PVP (€)	CUBA CENT.	PVP (€)
1000x600x850	IDX6910D	<b>713</b>	IDX6910I	<b>713</b>		
1200x600x850	IDX6912D	<b>742</b>	IDX6912I	<b>742</b>		
1400x600x850	IDX6914D	<b>776</b>	IDX6914I	<b>776</b>		
1500x600x850	IDX6915D	<b>794</b>	IDX6915I	<b>794</b>		
1600x600x850	IDX6916D	<b>828</b>	IDX6916I	<b>828</b>	IDX6916C	<b>845</b>
1800x600x850	IDX6918D	<b>868</b>	IDX6918I	<b>868</b>	IDX6918C	<b>880</b>
2000x600x850	IDX6920D	<b>955</b>	IDX6920I	<b>955</b>	IDX6920C	<b>978</b>

### Fondo 700

DIM (mm)	CUBA DCHA.	PVP (€)	CUBA IZQ.	PVP (€)	CUBA CENT.	PVP (€)
1000x700x850	IDX7910D	<b>782</b>	IDX7910I	<b>782</b>		
1200x700x850	IDX7912D	<b>822</b>	IDX7912I	<b>822</b>		
1400x700x850	IDX7914D	<b>857</b>	IDX7914I	<b>857</b>		
1500x700x850	IDX7915D	<b>874</b>	IDX7915I	<b>874</b>		
1600x700x850	IDX7916D	<b>897</b>	IDX7916I	<b>897</b>	IDX7916C	<b>920</b>
1800x700x850	IDX7918D	<b>955</b>	IDX7918I	<b>955</b>	IDX7918C	<b>972</b>
2000x700x850	IDX7920D	<b>1018</b>	IDX7920I	<b>1018</b>	IDX7920C	<b>1047</b>

## MESAS CENTRALES RECICLAJE ESTÁNDAR SOLDADAS H.850

- **Reforzadas** con omegas.
- **Frontal** soldado de 60mm en punto redondo.
- **Patas** de tubo 40x40 con taco regulable de 60mm. 6 patas a partir de 2000mm, 8 patas en 2400mm.



**Totalmente soldadas**  
Se suministran montadas y soldadas.

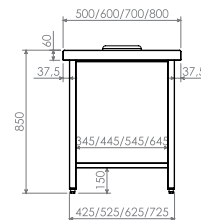

### Abiertas

LARGO (mm)	FONDO 500	PVP (€)	FONDO 600	PVP (€)	FONDO 700	PVP (€)	FONDO 800	PVP (€)
600 1 aro	IDC05306	511	IDC06306	527	IDC07306	539	IDC08306	584
800 2 aros	IDC05308	577	IDC06308	595	IDC07308	606	IDC08308	670
1000 2 aros	IDC05310	594	IDC06310	612	IDC07310	635	IDC08310	688
1200 2 aros	IDC05312	616	IDC06312	635	IDC07312	658	IDC08312	725
1400 3 aros	IDC05314	699	IDC06314	719	IDC07314	794	IDC08314	860
1500 3 aros	IDC05315	722	IDC06315	742	IDC07315	811	IDC08315	884
1600 3 aros	IDC05316	744	IDC06316	765	IDC07316	829	IDC08316	908
1800 4 aros	IDC05318	860	IDC06318	884	IDC07318	971	IDC08318	1043
2000 4 aros	IDC05320	894	IDC06320	919	IDC07320	994	IDC08320	1080
2200 4 aros	IDC05322	1016	IDC06322	1045	IDC07322	1097	IDC08322	1183
2400 5 aros	IDC05324	1088	IDC06324	1118	IDC07324	1176	IDC08324	1263

### Cerradas

- **Trasera y laterales** cerrados con chapa.
- **Puertas batientes** con bisagra pivotante.

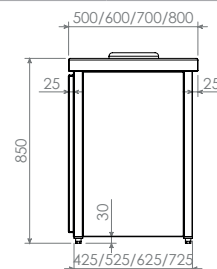

LARGO (mm)	FONDO 500	PVP (€)	FONDO 600	PVP (€)	FONDO 700	PVP (€)	FONDO 800	PVP (€)
600 1 P. / 1 aro	IDC05406	961	IDC06406	987	IDC07406	1009	IDC08406	1055
800 2 P. / 2 aros	IDC05408	1259	IDC06408	1289	IDC07408	1314	IDC08408	1379
1000 2 P. / 2 aros	IDC05410	1309	IDC06410	1341	IDC07410	1378	IDC08410	1432
1200 2 P. / 2 aros	IDC05412	1365	IDC06412	1398	IDC07412	1436	IDC08412	1504
1400 3 P. / 3 aros	IDC05414	1679	IDC06414	1717	IDC07414	1811	IDC08414	1878
1500 3 P. / 3 aros	IDC05415	1719	IDC06415	1757	IDC07415	1845	IDC08415	1920
1600 3 P. / 3 aros	IDC05416	1758	IDC06416	1797	IDC07416	1881	IDC08416	1961
1800 4 P. / 4 aros	IDC05418	2106	IDC06418	2151	IDC07418	2262	IDC08418	2335
2000 4 P. / 4 aros	IDC05420	2173	IDC06420	2220	IDC07420	2320	IDC08420	2407
2200 4 P. / 4 aros	IDC05422	2329	IDC06422	2382	IDC07422	2459	IDC08422	2547
2400 5 P. / 5 aros	IDC05424	2632	IDC06424	2689	IDC07424	2776	IDC08424	2865

### AROS Y TAPAS DESBARACE



DIM (mm)	REF	PVP (€)
Goma para aro desbarace 200Ø NEGRO	IDL45000	24
Goma para aro desbarace 200Ø AMARILLO	IDL45002	24
Goma para aro desbarace 200Ø VERDE	IDL45003	24
Goma para aro desbarace 200Ø AZUL	IDL45004	24
Goma para aro desbarace 200Ø ROJO	IDL45007	24
Tapa para aro desbarace 200Ø	IDL45001	46



**NOVEDAD**

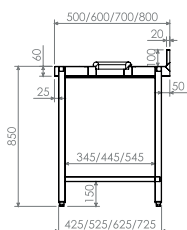

## MESAS MURALES **RECICLAJE** ESTÁNDAR **SOLDADAS** H.850

- **Reforzadas** con omegas.
- **Frontal** soldado de 60mm en punto redondo, **peto** posterior soldado de 100mm con radio sanitario.
- **Patas** de tubo 40x40 con taco regulable de 60mm. 6 patas a partir de 2000mm, 8 patas en 2400mm.



**Totalmente soldadas**  
Se suministran montadas y soldadas.

### Abiertas

LARGO (mm)	FONDO 500	PVP (€)	FONDO 600	PVP (€)	FONDO 700	PVP (€)	FONDO 800	PVP (€)
600 1 aro	IDM53006	<b>516</b>	IDM63006	<b>539</b>	IDM73006	<b>556</b>	IDM83006	<b>596</b>
800 2 aros	IDM53008	<b>583</b>	IDM63008	<b>612</b>	IDM73008	<b>641</b>	IDM83008	<b>675</b>
1000 2 aros	IDM53010	<b>600</b>	IDM63010	<b>629</b>	IDM73010	<b>658</b>	IDM83010	<b>715</b>
1200 2 aros	IDM53012	<b>623</b>	IDM63012	<b>658</b>	IDM73012	<b>692</b>	IDM83012	<b>750</b>
1400 3 aros	IDM53014	<b>708</b>	IDM63014	<b>725</b>	IDM73014	<b>823</b>	IDM83014	<b>880</b>
1500 3 aros	IDM53015	<b>731</b>	IDM63015	<b>754</b>	IDM73015	<b>846</b>	IDM83015	<b>898</b>
1600 3 aros	IDM53016	<b>754</b>	IDM63016	<b>771</b>	IDM73016	<b>869</b>	IDM83016	<b>915</b>
1800 4 aros	IDM53018	<b>873</b>	IDM63018	<b>925</b>	IDM73018	<b>999</b>	IDM83018	<b>1086</b>
2000 4 aros	IDM53020	<b>896</b>	IDM63020	<b>948</b>	IDM73020	<b>1034</b>	IDM83020	<b>1103</b>
2200 4 aros	IDM53022	<b>1005</b>	IDM63022	<b>1086</b>	IDM73022	<b>1132</b>	IDM83022	<b>1229</b>
2400 5 aros	IDM53024	<b>1095</b>	IDM63024	<b>1164</b>	IDM73024	<b>1210</b>	IDM83024	<b>1314</b>

### Cerradas

- **Trasera y laterales** cerrados con chapa.
- **Puertas batientes** con bisagra pivotante.

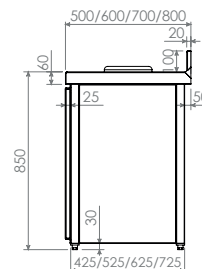

LARGO (mm)	FONDO 500	PVP (€)	FONDO 600	PVP (€)	FONDO 700	PVP (€)	FONDO 800	PVP (€)
600 1 P. / 1 aro	IDM54006	<b>966</b>	IDM64006	<b>1009</b>	IDM74006	<b>1027</b>	IDM84006	<b>1067</b>
800 2 P. / 2 aros	IDM54008	<b>1265</b>	IDM64008	<b>1320</b>	IDM74008	<b>1350</b>	IDM84008	<b>1384</b>
1000 2 P. / 2 aros	IDM54010	<b>1315</b>	IDM64010	<b>1372</b>	IDM74010	<b>1401</b>	IDM84010	<b>1459</b>
1200 2 P. / 2 aros	IDM54012	<b>1372</b>	IDM64012	<b>1436</b>	IDM74012	<b>1470</b>	IDM84012	<b>1529</b>
1400 3 P. / 3 aros	IDM54014	<b>1688</b>	IDM64014	<b>1740</b>	IDM74014	<b>1840</b>	IDM84014	<b>1898</b>
1500 3 P. / 3 aros	IDM54015	<b>1728</b>	IDM64015	<b>1787</b>	IDM74015	<b>1881</b>	IDM84015	<b>1934</b>
1600 3 P. / 3 aros	IDM54016	<b>1768</b>	IDM64016	<b>1821</b>	IDM74016	<b>1921</b>	IDM84016	<b>1968</b>
1800 4 P. / 4 aros	IDM54018	<b>2119</b>	IDM64018	<b>2215</b>	IDM74018	<b>2290</b>	IDM84018	<b>2379</b>
2000 4 P. / 4 aros	IDM54020	<b>2175</b>	IDM64020	<b>2273</b>	IDM74020	<b>2360</b>	IDM84020	<b>2431</b>
2200 4 P. / 4 aros	IDM54022	<b>2318</b>	IDM64022	<b>2448</b>	IDM74022	<b>2495</b>	IDM84022	<b>2594</b>
2400 5 P. / 5 aros	IDM54024	<b>2639</b>	IDM64024	<b>2764</b>	IDM74024	<b>2811</b>	IDM84024	<b>2917</b>



## MESAS PREPARACIÓN ESTÁNDAR SOLDADAS

- **Reforzadas** con omegas.
- **Frontal** soldado de 60mm en punto redondo, **peto** posterior soldado de 100mm con radio sanitario.
- **Cubas** soldadas radio sanitario.
- **Aro** desbarace de chapa embutida.
- **Polietileno** 20mm para corte.
- **Patas** de tubo 40x40 con taco regulable de 60mm.

**Totalmente soldadas**  
Se suministran montadas y soldadas.



### Mesas preparación verdura 1 cuba

DIM (mm)	CUBA	REF	PVP (€)
1200x700x850	1000x300x200	IDM712PV	<b>1277</b>
1400x700x850	1200x300x200	IDM714PV	<b>1323</b>

### Mesas preparación verdura 2 cubas

DIM (mm)	CUBAS	REF	PVP (€)
1600x700x850	700x300x200	IDM716PV	<b>1438</b>
1800x700x850	800x300x200	IDM718PV	<b>1507</b>

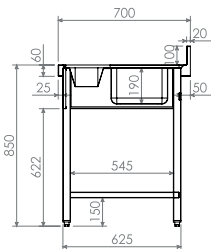

### Mesas preparación carnes/pescados

DIM (mm)	CUBA	REF	PVP (€)
1200x700x850	no	IDM712PC	<b>1156</b>
1400x700x850	no	IDM714PC	<b>1271</b>

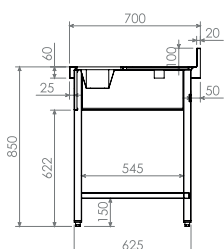

## Mesas preparación y lavado carnes/pescados

DIM (mm)	CUBA	POLIETILENO	REF	PVP (€)
1000x500x850	Ø380mm IZQ	AZUL	IDM0510A	<b>920</b>
1000x500x850	Ø380mm DCHA	AZUL	IDM1510A	<b>920</b>
1500x500x850	Ø380mm CENT	AZUL	IDM0515A	<b>1115</b>
1000x500x850	Ø380mm IZQ	ROJO	IDM0510R	<b>920</b>
1000x500x850	Ø380mm DCHA	ROJO	IDM1510R	<b>920</b>
1500x500x850	Ø380mm CENT	ROJO	IDM0515R	<b>1115</b>

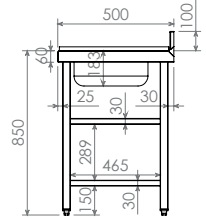

## Complementos mesa chef/preparación

CARACTERÍSTICAS	REF	PVP (€)
Delantal frontal derecho mesa mural chef estándar con cuba	IDL45620D	<b>109</b>
Delantal frontal izquierdo mesa mural chef estándar con cuba	IDL45620I	<b>109</b>
Delantal frontal central mesa mural chef estándar con cuba	IDL45620C	<b>109</b>
Delantal frontal derecho con pulsador temporizado + mezclador 2 aguas + caño	IDL45630D	<b>316</b>
Delantal frontal izquierdo con pulsador temporizado + mezclador 2 aguas + caño	IDL45630I	<b>316</b>
Delantal frontal central con pulsador temporizado + mezclador 2 aguas + caño	IDL45630C	<b>316</b>
Adaptación de sensor + electro-válvula + mezclador 2 aguas + caño.	IDL45700	<b>604</b>



## ENCIMERAS CENTRALES ESTÁNDAR

- **Reforzadas** con omegas.
- **Frontal** soldado de 60mm en punto redondo.

\*Posibilidad de incorporar cartelas de sujeción.

Medidas especiales en gama flexi estándar página 211.

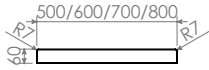

LARGO (mm)	FONDO 500	PVP (€)	FONDO 600	PVP (€)	FONDO 700	PVP (€)	FONDO 800	PVP (€)
600	IDE05106	261	IDE06106	270	IDE07106	322	IDE08106	368
800	IDE05108	272	IDE06108	282	IDE07108	334	IDE08108	374
1000	IDE05110	283	IDE06110	293	IDE07110	345	IDE08110	385
1200	IDE05112	305	IDE06112	316	IDE07112	368	IDE08112	426
1400	IDE05114	333	IDE06114	345	IDE07114	403	IDE08114	443
1500	IDE05115	361	IDE06115	374	IDE07115	431	IDE08115	460
1600	IDE05116	394	IDE06116	408	IDE07116	466	IDE08116	518
1800	IDE05118	438	IDE06118	454	IDE07118	512	IDE08118	569
2000	IDE05120	466	IDE06120	483	IDE07120	546	IDE08120	598
2200	IDE05122	494	IDE06122	512	IDE07122	575	IDE08122	638
2400	IDE05124	527	IDE06124	546	IDE07124	610	IDE08124	667

## ENCIMERAS MURALES ESTÁNDAR

- **Reforzadas** con omegas.
- **Frontal** soldado de 60mm en punto redondo,  
**peto posterior** soldado de 100mm con radio sanitario.

\*Posibilidad de incorporar cartelas de sujeción.

Medidas especiales en gama flexi estándar página 211.

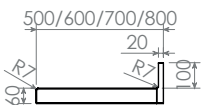

LARGO (mm)	FONDO 500	PVP (€)	FONDO 600	PVP (€)	FONDO 700	PVP (€)	FONDO 800	PVP (€)
600	IDE05006	270	IDE06006	293	IDE07006	345	IDE08006	386
800	IDE05008	276	IDE06008	305	IDE07008	357	IDE08008	400
1000	IDE05010	293	IDE06010	316	IDE07010	368	IDE08010	412
1200	IDE05012	322	IDE06012	339	IDE07012	397	IDE08012	445
1400	IDE05014	351	IDE06014	368	IDE07014	437	IDE08014	489
1500	IDE05015	385	IDE06015	397	IDE07015	454	IDE08015	509
1600	IDE05016	414	IDE06016	431	IDE07016	477	IDE08016	535
1800	IDE05018	460	IDE06018	477	IDE07018	535	IDE08018	599
2000	IDE05020	483	IDE06020	506	IDE07020	569	IDE08020	638
2200	IDE05022	512	IDE06022	535	IDE07022	598	IDE08022	670
2400	IDE05024	541	IDE06024	569	IDE07024	633	IDE08024	709



- **Reforzadas** con omegas.
- **Frontal** soldado de 60mm en punto redondo, **peto posterior** soldado de 100mm con radio sanitario.
- **Cuba** soldada 400x340x200mm en encimeras fondo 500. Cuba soldada 400x400x200mm en encimeras fondo 600 y 700mm.

Posibilidad de sujeción mediante cartelas.



Cuba derecha



Cuba izquierda



Cuba central

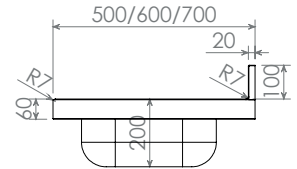

### Fondo 500

DIM (mm)	CUBA DCHA.	PVP (€)	CUBA IZQ.	PVP (€)
1200x500x60	IDXE512D	<b>454</b>	IDXE512I	<b>454</b>
1500x500x60	IDXE515D	<b>546</b>	IDXE515I	<b>546</b>
1800x500x60	IDXE518D	<b>650</b>	IDXE518I	<b>650</b>

### Fondo 600

DIM (mm)	CUBA DCHA.	PVP (€)	CUBA IZQ.	PVP (€)	CUBA CENT.	PVP (€)
1000x600x60	IDXE610D	<b>443</b>	IDXE610I	<b>443</b>		
1200x600x60	IDXE612D	<b>472</b>	IDXE612I	<b>472</b>		
1400x600x60	IDXE614D	<b>518</b>	IDXE614I	<b>518</b>		
1500x600x60	IDXE615D	<b>564</b>	IDXE615I	<b>564</b>		
1600x600x60	IDXE616D	<b>615</b>	IDXE616I	<b>615</b>	IDXE616C	<b>627</b>
1800x600x60	IDXE618D	<b>667</b>	IDXE618I	<b>667</b>	IDXE618C	<b>679</b>
2000x600x60	IDXE620D	<b>719</b>	IDXE620I	<b>719</b>	IDXE620C	<b>730</b>

### Fondo 700

DIM (mm)	CUBA DCHA.	PVP (€)	CUBA IZQ.	PVP (€)	CUBA CENT.	PVP (€)
1000x700x60	IDXE710D	<b>489</b>	IDXE710I	<b>489</b>		
1200x700x60	IDXE712D	<b>523</b>	IDXE712I	<b>523</b>		
1400x700x60	IDXE714D	<b>569</b>	IDXE714I	<b>569</b>		
1500x700x60	IDXE715D	<b>610</b>	IDXE715I	<b>610</b>		
1600x700x60	IDXE716D	<b>661</b>	IDXE716I	<b>661</b>	IDXE716C	<b>684</b>
1800x700x60	IDXE718D	<b>713</b>	IDXE718I	<b>713</b>	IDXE718C	<b>725</b>
2000x700x60	IDXE720D	<b>771</b>	IDXE720I	<b>771</b>	IDXE720C	<b>794</b>



## MESAS/ENCIMERAS ANGULARES ESTÁNDAR DESMONTADAS/SOLDADAS

- **Reforzadas** con omegas.
- **Frontal** soldado de 60mm en punto redondo, peto **posterior** y **lateral** soldados de 100mm con radio sanitario.
- **Patas** de tubo 40x40mm con taco regulable de 60mm.

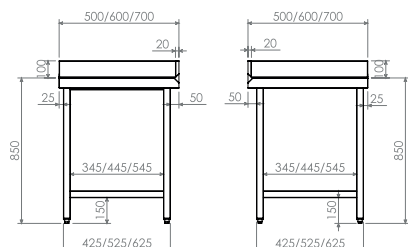

DIM (mm)	MESA DESMONTADA	PVP (€)	MESA SOLDADA	PVP (€)	ENCIMERA	PVP (€)
500x500x850	IDM5050D	529	IDM50050	558	IDE50050	368
500x600x850	IDM5060D	552	IDM50060	581	IDE50060	385
500x700x850	IDM5070D	598	IDM50070	627	IDE50070	408
600x500x850	IDM6050D	552	IDM60050	581	IDE60050	385
600x600x850	IDM6060D	575	IDM60060	604	IDE60060	414
600x700x850	IDM6070D	610	IDM60070	638	IDE60070	431
700x500x850	IDM7050D	598	IDM70050	627	IDE70050	408
700x600x850	IDM7060D	610	IDM70060	638	IDE70060	431
700x700x850	IDM7070D	627	IDM70070	661	IDE70070	472

## PILONAS DE CORTE

- Estante opcional **reforzado** con omega.
- Taco de **polietileno** blanco superior de 50mm de espesor reversible.
- **Estructura y patas** de tubo 40x40mm.

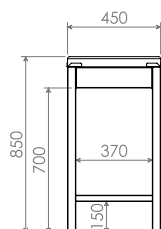

**Totalmente soldadas**  
Se suministran montadas y soldadas.



DIM (mm)		REF	PVP (€)
450x450x850	Marco refuerzo	IDC04545	431
450x450x850	1 estante	IDC14545	506
395x65x275	cuchillero	IDH04595	127



## MESAS SOPORTE HORNO CON GUÍAS ESTÁNDAR **SOLDADAS**



- **Reforzadas** con omegas.
- **Frontal** soldado de 60mm en punto redondo.
- Cuerpos de **guía** de chapa 1.5mm de espesor.
- **Patas** de tubo 40x40mm con taco regulable de 60mm.



**Totalmente soldadas**  
Se suministran montadas y soldadas.

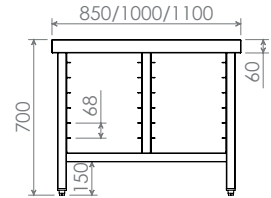

DIM (mm)		REF	PVP (€)
850x750x700	2 cuerpos de guía para 6 GN 1/1	IDC75090	<b>792</b>
850x950x700	2 cuerpos de guía para 6 GN 1/1	IDC95090	<b>840</b>
1000x750x700	2 cuerpos de guía para 6 bandejas 600x400mm	IDC75100	<b>828</b>
1000x950x700	2 cuerpos de guía para 6 bandejas 600x400mm	IDC95100	<b>942</b>
1100x750x700	2 cuerpos de guía para 12 GN 1/1 o 6 GN 2/1	IDC75110	<b>954</b>
1100x950x700	2 cuerpos de guía para 12 GN 1/1 o 6 GN 2/1	IDC95110	<b>1020</b>



## SOPORTES Y CARTELAS DE SUJECIÓN PARA ENCIMERAS ESTÁNDAR

REF	CARACTERÍSTICAS	PVP (€)
IDH04565	Soporte con pata para encimera fondo 500mm	<b>132</b>
IDH04566	Soporte con pata para encimera fondo 600mm	<b>144</b>
IDH04567	Soporte con pata para encimera fondo 700mm	<b>155</b>
IDH04575	Soporte central de tubo para encimera fondo 500mm	<b>109</b>
IDH04576	Soporte central de tubo para encimera fondo 600mm	<b>115</b>
IDH04577	Soporte central de tubo para encimera fondo 700mm	<b>121</b>
IDH04585D	Cartela de sujeción derecha en chapa de 1,5 mm para encimera fondo 500mm	<b>46</b>
IDH04585I	Cartela de sujeción izquierda en chapa de 1,5 mm para encimera fondo 500mm	<b>46</b>
IDH04586D	Cartela de sujeción derecha en chapa de 1,5 mm para encimera fondo 600mm	<b>52</b>
IDH04586I	Cartela de sujeción izquierda en chapa de 1,5 mm para encimera fondo 600mm	<b>52</b>
IDH04587D	Cartela de sujeción derecha en chapa de 1,5 mm para encimera fondo 700mm	<b>58</b>
IDH04587I	Cartela de sujeción izquierda en chapa de 1,5 mm para encimera fondo 700mm	<b>58</b>

## ACCESORIOS MESAS Y ENCIMERAS ESTÁNDAR

- Se suministran con todo lo necesario para su montaje.

Medidas especiales en gama flexi estándar página 205.

Se suministran desmontados  
Rápido y fácil montaje en mesas.



### Cajones individuales para mesa

DIM (mm)	REF	PVP (€)
400x450x165	IDH04500	207
450x450x165	IDH04501	219

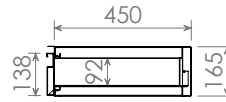

### Módulos tolva

DIM (mm)	REF	PVP (€)
450x415x600 mesa fondo 500	IDH04515	575
450x515x600 mesa fondo 600	IDH04516	587
450x615x600 mesa fondo 700/800	IDH04517	598

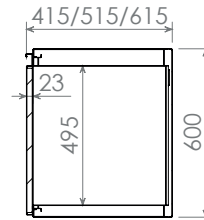

### Módulos 2 cajones simétricos

DIM (mm)	REF	PVP (€)
450x415x600 mesa fondo 500	IDH04525	592
450x515x600 mesa fondo 600	IDH04526	604
450x615x600 mesa fondo 700/800	IDH04527	621

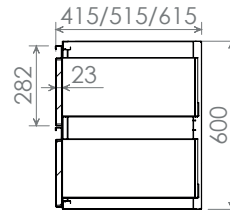

### NOVEDAD

### Módulos 2 cajones asimétricos

DIM (mm)	REF	PVP (€)
450x415x600 mesa fondo 500	IDH04585	603
450x515x600 mesa fondo 600	IDH04586	620
450x615x600 mesa fondo 700/800	IDH04587	640

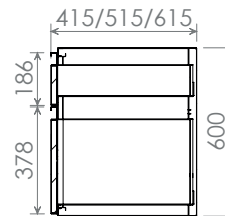

### Módulos 3 cajones

DIM (mm)	REF	PVP (€)
450x415x600 mesa fondo 500	IDH04535	610
450x515x600 mesa fondo 600	IDH04536	627
450x615x600 mesa fondo 700/800	IDH04537	644

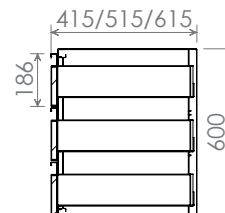

## Módulos 4 cajones

DIM (mm)		REF	PVP (€)
450x415x600	mesa fondo 500	IDH04545	<b>656</b>
450x515x600	mesa fondo 600	IDH04546	<b>679</b>
450x615x600	mesa fondo 700/800	IDH04547	<b>702</b>

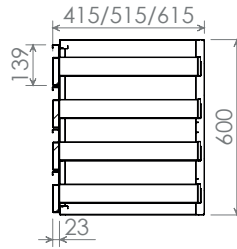

## Módulos cuerpo guías plafonados

DIM (mm)		REF	PVP (€)
420x550x600	mesas fondo 600/700-GN1/1	IDH04511	<b>541</b>
625x670x600	mesas fondo 700/800-GN2/1	IDH04521	<b>564</b>
495x620x600	mesas fondo 700/800-600x400mm	IDH04564	<b>587</b>

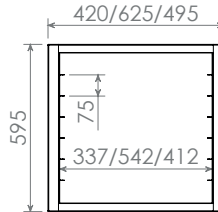

## Módulos cuerpo guías abiertos

DIM (mm)		REF	PVP (€)
420x550x600	mesas fondo 600/700-GN1/1	IDH04611	<b>357</b>
625x670x600	mesas fondo 700/800-GN2/1	IDH04621	<b>414</b>
495x620x600	mesas fondo 700/800-600x400mm	IDH04664	<b>391</b>

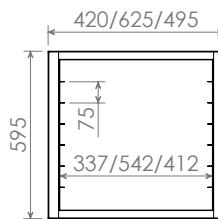

## Cuchilleros

DIM (mm)		REF	PVP (€)
395x65x275	mesa fondo 500	IDH04595	<b>127</b>
495x65x275	mesa fondo 600	IDH04596	<b>132</b>
595x65x275	mesa fondo 700	IDH04597	<b>138</b>
695x65x275	mesa fondo 800	IDH04598	<b>150</b>

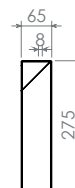

### Plafones laterales para mesa h850mm

DIM (mm)		REF	PVP (€)
345x30x650	mesa fondo 500	IDH90500	<b>109</b>
445x30x650	mesa fondo 600	IDH90600	<b>115</b>
545x30x650	mesa fondo 700	IDH90700	<b>127</b>
645x30x650	mesa fondo 800	IDH90800	<b>138</b>



### Plafones traseros para mesa h850mm

DIM (mm)		REF	PVP (€)
470x30x650	mesa largo 600	IDH90806	<b>121</b>
570x30x650	mesa largo 800	IDH90808	<b>132</b>
770x30x650	mesa largo 1000	IDH90810	<b>144</b>
970x30x650	mesa largo 1200	IDH90812	<b>155</b>
1170x30x650	mesa largo 1400	IDH90814	<b>178</b>
1270x30x650	mesa largo 1500	IDH90815	<b>201</b>
1370x30x650	mesa largo 1600	IDH90816	<b>219</b>
1570x30x650	mesa largo 1800	IDH90818	<b>230</b>
1770x30x650	mesa largo 2000	IDH90820	<b>242</b>
1970x30x650	mesa largo 2200 (2 partes)	IDH90822	<b>265</b>
2170x30x650	mesa largo 2400 (2 partes)	IDH90824	<b>276</b>



### Plafones laterales para mesa h600mm

DIM (mm)		REF	PVP (€)
345x30x400	mesa fondo 500	IDH96500	<b>81</b>
445x30x400	mesa fondo 600	IDH96600	<b>86</b>
545x30x400	mesa fondo 700	IDH96700	<b>98</b>
645x30x400	mesa fondo 800	IDH96800	<b>109</b>



### Plafones traseros para mesa h600mm

DIM (mm)		REF	PVP (€)
470x30x400	mesa largo 600	IDH90606	<b>98</b>
570x30x400	mesa largo 800	IDH90608	<b>109</b>
770x30x400	mesa largo 1000	IDH90610	<b>115</b>
970x30x400	mesa largo 1200	IDH90612	<b>127</b>
1170x30x400	mesa largo 1400	IDH90614	<b>144</b>
1270x30x400	mesa largo 1500	IDH90615	<b>161</b>
1370x30x400	mesa largo 1600	IDH90616	<b>178</b>
1570x30x400	mesa largo 1800	IDH90618	<b>184</b>
1770x30x400	mesa largo 2000	IDH90620	<b>196</b>
1970x30x400	mesa largo 2200 (2 partes)	IDH90622	<b>213</b>
2170x30x400	mesa largo 2400 (2 partes)	IDH90624	<b>224</b>





## Peto lateral postizo

DIM (mm)		REF	PVP (€)
480x20x100	mesa fondo 500	IDH9050D	121
480x20x100	mesa fondo 500	IDH9050I	121
580x20x100	mesa fondo 600	IDH9060D	127
580x20x100	mesa fondo 600	IDH9060I	127
680x20x100	mesa fondo 700	IDH9070D	132
680x20x100	mesa fondo 700	IDH9070I	132
780x20x100	mesa fondo 800	IDH9080D	138
780x20x100	mesa fondo 800	IDH9080I	138

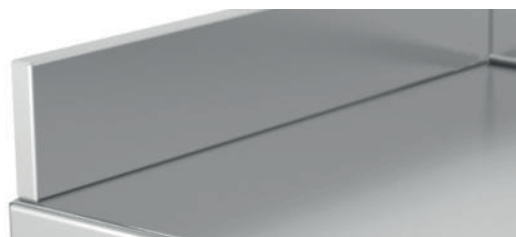

## Zócalos frontales/posteriores para mesa

DIM (mm)	REF	PVP (€)
mesa largo 600	IDH92060	92
mesa largo 800	IDH92080	115
mesa largo 1000	IDH92100	138
mesa largo 1200	IDH92120	161
mesa largo 1400	IDH92140	184
mesa largo 1500	IDH92150	196
mesa largo 1600	IDH92160	207
mesa largo 1800	IDH92180	230
mesa largo 2000	IDH92200	253
mesa largo 2200 (2 partes)	IDH92220	288
mesa largo 2400 (2 partes)	IDH92240	311



## Zócalos laterales para mesa

DIM (mm)	REF	PVP (€)
para mesa fondo 500	IDH92500	92
para mesa fondo 600	IDH92600	98
para mesa fondo 700	IDH92700	104
para mesa fondo 800	IDH92800	115

## Adaptación de ruedas sintéticas

DIM (mm)	REF	PVP (€)
4 RUEDAS 100Ø, (2 con freno)	IDH90410	247
6 RUEDAS 100Ø, (3 con freno)	IDH90420	351



## Adaptación de ruedas inoxidables

DIM (mm)	REF	PVP (€)
4 RUEDAS 100Ø, (2 con freno)	IDH90430	293
6 RUEDAS 100Ø, (3 con freno)	IDH90440	385





# 07.

- Estanterías sobremesa
- Soporte portacubetas
- Pantallas
- Estanterías murales y soportes
- Estanterías regulables y desmontables
- Estanterías de aluminio y accesorios



## ESTANTERÍAS SOBREMESA

### Simple y Dobles

- **Reforzadas** con omegas inox.
- **6 patas** a partir de 2100mm.

Medidas especiales en gama flexi estándar página 207.

Dotación de conteras y tornillos para su fijación a encimera.



Totamente soldadas

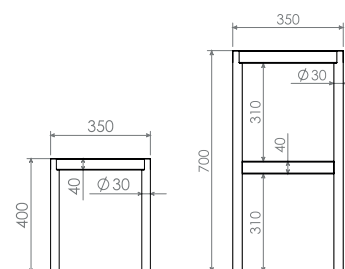

#### SIMPLES

DIM (mm)	REF	PVP(€)
700x350x400	IDP09307	328
900x350x400	IDP09309	339
1100x350x400	IDP09311	351
1300x350x400	IDP09313	362
1500x350x400	IDP09315	374
1700x350x400	IDP09317	391
1900x350x400	IDP09319	403
2100x350x400	IDP09321	426
2300x350x400	IDP09323	449



#### DOBLES

DIM (mm)	REF	PVP(€)
700x350x700	IDP09407	443
900x350x700	IDP09409	460
1100x350x700	IDP09411	477
1300x350x700	IDP09413	495
1500x350x700	IDP09415	512
1700x350x700	IDP09417	529
1900x350x700	IDP09419	546
2100x350x700	IDP09421	575
2300x350x700	IDP09423	610



#### NOVEDAD

### SOPORTE PORTACUBETAS PARA ESTANTERÍAS

- Preparados para incorporarse bajo estante de sobremesa simple / doble O BAJO ESTANTERIAS MURALES.

Cubetas no incluidas, consultar página 106.

Carga limitada a 5kg.

DIM (mm)	CAPACIDAD	REF	PVP(€)
340x170x120	2 GN 1/6	IDP09526	128
370x105x100	2 GN 1/9	IDP09529	152
510x170x120	3 GN 1/6	IDP09536	119
550x105x100	3 GN 1/9	IDP09539	140



Ejemplo de montaje.

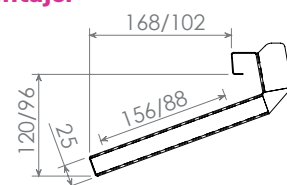

# 07.

## GAMA AMPLIADA

### PANTALLAS CON LUZ Y CALOR PARA ESTANTERÍAS DE SOBREMESA

- Calor mediante lámparas de luz **halógena** 230w o resistencias **cerámicas** (según modelo).
- **Interruptor** ON/OFF luminoso.

Se suministran preparadas para incorporarse bajo estante de sobremesa simple o doble.



#### Calor resistencias cerámicas

DIM (mm)	CONSUMO	REF	PVP(€)
600x150x60	500w/230v	IDPC1060	569
1000x150x60	750w/230v	IDPC1100	638
1200x150x60	750w/230v	IDPC1120	673
1400x150x60	1000w/230v	IDPC1140	707
1600x150x60	1250w/230v	IDPC1160	759
2000x150x60	1500w/230v	IDPC1200	822

#### Calor resistencias cerámicas + luz

DIM (mm)	CONSUMO	REF	PVP(€)
600x150x60	550w/230v	IDPC2060	633
1000x150x60	840w/230v	IDPC2100	696
1200x150x60	840w/230v	IDPC2120	742
1400x150x60	1130w/230v	IDPC2140	788
1600x150x60	1420w/230v	IDPC2160	845
2000x150x60	1710w/230v	IDPC2200	914

#### Calor y luz halógeno

DIM (mm)	CONSUMO	REF	PVP(€)
600x150x60	230w/230v	IDPC0060	512
1000x150x60	460w/230v	IDPC0100	575
1200x150x60	460w/230v	IDPC0120	607
1400x150x60	690w/230v	IDPC0140	638
1600x150x60	920w/230v	IDPC0160	684
2000x150x60	1150w/230v	IDPC0200	742

### ESTANTERÍAS SOBREMESA EMPLATAR PLATE MATE

- Plásticos **especiales**, cauchos Santoprene y aluminio reforzado.
- **Ajuste** altura platos mediante regulador superior.

DIM (mm)	CAPACIDAD	REF	PVP(€)
200x200x490	12 platos	IDP37712	305
360x360x730	24 platos	IDP37724	541
360x360x930	36 platos	IDP37736	679
360x360x1140	48 platos	IDP37748	845



Se suministran desmontadas  
Rápido y fácil montaje





## ESTANTERÍAS MURALES

### Fondo 250/400

- Cartela central de **refuerzo** a partir de 2000mm.

**Medidas especiales en gama flexi estándar página 206.**

**Dotación de tacos y tornillos para su instalación.**

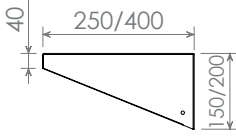

#### FONDO 250

DIM (mm)	REF	PVP(€)
600x250x150	IDP00625	<b>115</b>
800x250x150	IDP00825	<b>127</b>
1000x250x150	IDP01025	<b>144</b>
1200x250x150	IDP01225	<b>155</b>
1400x250x150	IDP01425	<b>161</b>
1500x250x150	IDP01525	<b>173</b>
1600x250x150	IDP01625	<b>184</b>
1800x250x150	IDP01825	<b>201</b>
2000x250x150	IDP02025	<b>230</b>
2200x250x150	IDP02225	<b>276</b>
2400x250x150	IDP02425	<b>305</b>



**Totalmente soldadas**

# 07.



#### FONDO 400

DIM (mm)	REF	PVP(€)
600x400x200	IDP00640	<b>127</b>
800x400x200	IDP00840	<b>155</b>
1000x400x200	IDP01040	<b>178</b>
1200x400x200	IDP01240	<b>190</b>
1400x400x200	IDP01440	<b>201</b>
1500x400x200	IDP01540	<b>213</b>
1600x400x200	IDP01640	<b>230</b>
1800x400x200	IDP01840	<b>253</b>
2000x400x200	IDP02040	<b>282</b>
2200x400x200	IDP02240	<b>322</b>
2400x400x200	IDP02440	<b>351</b>

## ESTANTERÍAS MURALES DE TUBO

- **Tubos** superiores de  $\varnothing 30$ mm tapados con conteras imitación acero.

**Medidas especiales en gama flexi estándar página 206.**

**Dotación de tacos y tornillos para su instalación.**

DIM (mm)	REF	PVP(€)
600x400x200	IDP10640	<b>184</b>
800x400x200	IDP10840	<b>196</b>
1000x400x200	IDP11040	<b>219</b>
1200x400x200	IDP11240	<b>242</b>
1400x400x200	IDP11440	<b>259</b>
1500x400x200	IDP11540	<b>276</b>
1600x400x200	IDP11640	<b>288</b>
1800x400x200	IDP11840	<b>299</b>
2000x400x200	IDP12040	<b>328</b>
2200x400x200	IDP12240	<b>357</b>
2400x400x200	IDP12440	<b>391</b>



**Totalmente soldadas**

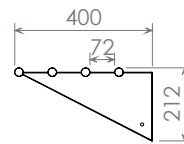

# 07.

## BARRA COLGADOR PARA ESTANTERÍA MURAL/TUBOS

- **Tubo** de  $\varnothing 13\text{mm}$  roscado en los extremos.
- **Sujeción** a cartelas mediante tornillos.

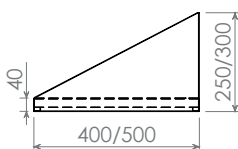

Totamente soldadas



DIM (mm)	REF	PVP(€)
600x13 $\varnothing$	IDP00690	29
800x13 $\varnothing$	IDP00890	35
1000x13 $\varnothing$	IDP01090	40
1200x13 $\varnothing$	IDP01290	46
1400x13 $\varnothing$	IDP01490	52
1500x13 $\varnothing$	IDP01590	58
1600x13 $\varnothing$	IDP01690	63
1800x13 $\varnothing$	IDP01890	69
2000x13 $\varnothing$	IDP02090	75
2200x13 $\varnothing$ dos partes	IDP02290	81
2400x13 $\varnothing$ dos partes	IDP02490	86

## ESTANTERÍAS CARTELAS INVERTIDAS

- **Agujero** posterior pasacables  $\varnothing 52\text{mm}$ .

Dotación de tacos y tornillos para su instalación.

DIM (mm)	REF	PVP(€)
600x400x250	IDP24006	201
1100x400x250	IDP24010	242
700x500x300	IDP25007	247
1200x500x300	IDP25012	322

## ESTANTERÍAS MURALES EMPLATAR PLATE MATE

- Plásticos **especiales**, cauchos Santoprene y aluminio reforzado.
- **Ajuste** altura platos mediante regulador superior.

Dotación de tacos y tornillos para su instalación.

DIM (mm)	CAPACIDAD	REF	PVP(€)
70x70x570	6 platos	IDP37006	184
70x70x770	9 platos	IDP37009	196
70x70x990	12 platos	IDP37012	219
70x70x1390	18 platos	IDP37018	242
70x70x1590	21 platos	IDP37021	259

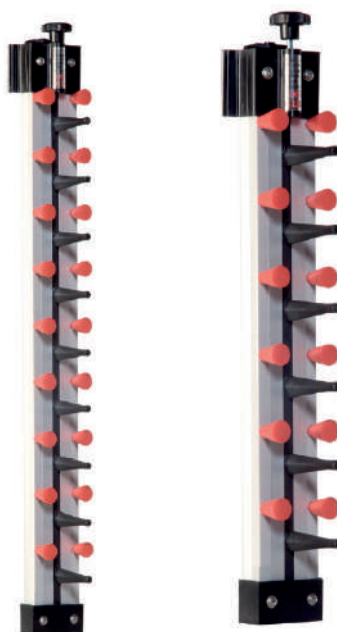

## ESTANTERÍAS MURALES DE CAMPANA

- Parrillas **desmontables**.
- Cartela central de **refuerzo** a partir de 2000mm.

**Dotación de tacos y tornillos para su instalación.**

DIM (mm)	REF	PVP(€)
770x380x240	IDP38008	299
1120x380x240	IDP38012	380
1655x380x240	IDP38016	449
2215x380x240	IDP38022	495

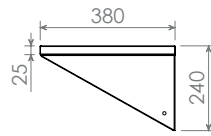

**Totalmente soldadas**



## BARRAS COLGADOR PARA ESTANTERÍAS CAMPANA

- **Tubo** de  $\varnothing 13\text{mm}$  roscado en los extremos, sujeción a cartelas mediante tornillos.

DIM (mm)	REF	PVP(€)
770x13 $\varnothing$	IDP38908	35
1120x13 $\varnothing$	IDP38912	46
1655x13 $\varnothing$	IDP38916	63
2215x13 $\varnothing$ dos partes	IDP38922	81



## ESTANTERÍAS MURALES ESCURREPLATOS

- Parrillas **desmontables**.

**Dotación de tacos y tornillos para su instalación.**

DIM (mm)	REF	PVP(€)
1000x300x240	IDP30010	339
1200x300x240	IDP30012	385
1500x300x240	IDP30015	437

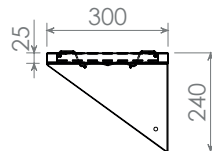

**Totalmente soldadas**



## BARRAS COLGADOR PARA ESTANTERÍAS ESCURREPLATOS

- **Tubo** de  $\varnothing 13\text{mm}$  roscado en los extremos, sujeción a cartelas mediante tornillos.

DIM (mm)	REF	PVP(€)
1000x13 $\varnothing$	IDP30910	40
1200x13 $\varnothing$	IDP30912	46
1500x13 $\varnothing$	IDP30915	58



## SOPORTES MURALES PARA UTENSILIOS

Dotación de tacos y tornillos para su instalación.



DIM (mm)	REF	PVP(€)
500x40x40	IDP43005	80
1000x40x40	IDP43010	95

## BARRAS DE COLGAR

Dotación de tacos y tornillos para su instalación.

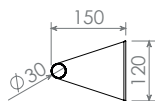

Totamente soldadas



DIM (mm)	REF	PVP(€)
1000x150x120	IDP81510	132
1200x150x120	IDP81512	144
1500x150x120	IDP81515	155
1800x150x120	IDP81518	167
2000x150x120	IDP81520	184



## CUELGACOPAS

- Capacidad para 3/4 copas.

Dotación de tacos y tornillos para su instalación.

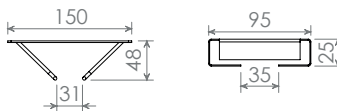

DIM (mm)	REF	PVP(€)
300x150x50 VARILLA	IDP43015	40
300x95x25 CHAPA	IDP43020	23

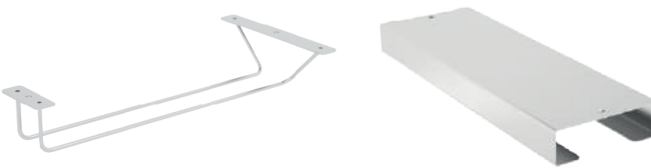

## ESTANTES SOBREMESA PORTACUBETAS

Cubetas no incluidas, consultar páginas 105-106.

DIM (mm)	CAPACIDAD	REF	PVP(€)
750x360x300	1 GN 1/1 + 1 GN 1/3	IDP09907	167
1100x360x300	2 GN 1/1	IDP09911	196
1450x360x300	2 GN 1/1 + 1 GN 2/3	IDP09914	224



## ESTANTERÍAS MURALES REGULABLES

- **Regulación** de estantes mediante cremallera en montantes.

**Cubetas no incluidas, consultar página 106.**

**Dotación de tacos y tornillos para su instalación.**

**Se suministran desmontadas**  
Rápido y fácil montaje



### Montantes

DIM (mm)	REF	PVP(€)
700X40x20	IDP71007	29
1000X40x20	IDP71010	40
1500X40x20	IDP71015	46

### Estantes lisos

DIM (mm)	REF	PVP(€)
1000X250x40	IDP71025	92
1200X250x40	IDP71225	121
1400X250x40	IDP71425	138
1500X250x40	IDP71525	155
1000x400x40	IDP71040	132
1200X400x40	IDP71240	161
1400X400x40	IDP71440	184
1500X400x40	IDP71540	201

### Estantes inclinados

DIM (mm)	REF	PVP(€)
1000x250 - 4GN 1/6	IDP71925	115
1000x400 - 4 GN 1/3	IDP71940	155

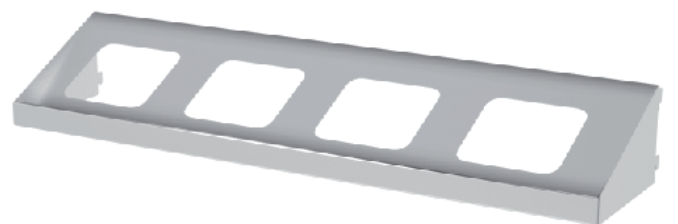



# 07.



**Se suministran desmontadas**  
Rápido y fácil montaje

## ESTANTERÍAS DE PIE ACERO INOX DESMONTABLES

- **Montantes** de 2 mm con regulación de estante cada 150mm mediante tornillos.
- **Estantes** de 1 mm o 1.5 mm de grosor a elegir.
- Opción de omegas de **refuerzo** inferior.

**Dotación de tornillería para su instalación.**

### Estantes 1mm/1,5mm

DIM (mm)	CARGA	1 mm	PVP(€)	CARGA	1,5 mm	PVP(€)
800x300x40	230kg	IDP58308	<b>63</b>	300kg	IDP59308	<b>86</b>
1000x300x40	180kg	IDP58310	<b>75</b>	250kg	IDP59310	<b>98</b>
1200x300x40	130kg	IDP58312	<b>86</b>	150kg	IDP59312	<b>109</b>
1400x300x40	105kg	IDP58314	<b>98</b>	125kg	IDP59314	<b>121</b>
800x400x40	205kg	IDP58408	<b>75</b>	275kg	IDP59408	<b>98</b>
1000x400x40	155kg	IDP58410	<b>86</b>	225kg	IDP59410	<b>109</b>
1200x400x40	105kg	IDP58412	<b>98</b>	125kg	IDP59412	<b>121</b>
1400x400x40	80kg	IDP58414	<b>109</b>	100kg	IDP59414	<b>132</b>
800x500x40	200kg	IDP58508	<b>92</b>	275kg	IDP59508	<b>115</b>
1000x500x40	150kg	IDP58510	<b>104</b>	225kg	IDP59510	<b>127</b>
1200x500x40	100kg	IDP58512	<b>115</b>	125kg	IDP59512	<b>138</b>
1400x500x40	75kg	IDP58514	<b>127</b>	100kg	IDP59514	<b>150</b>
800x600x40	180kg	IDP58608	<b>104</b>	250kg	IDP59608	<b>127</b>
1000x600x40	130kg	IDP58610	<b>115</b>	200kg	IDP59610	<b>138</b>
1200x600x40	80kg	IDP58612	<b>127</b>	100kg	IDP59612	<b>150</b>
1400x600x40	55kg	IDP58614	<b>138</b>	75kg	IDP59614	<b>161</b>

\* Las cargas se consideran repartidas uniformemente en la superficie del estante.



### Soportes ángulo vertical 2mm

800kg de **carga** máxima por conjunto de 4 soportes.

DIM (mm)	REF	PVP(€)
40/40x1900 • 11 niveles	IDP58419	<b>52</b>
40/40x2250 • 14 niveles	IDP58422	<b>58</b>



### Omegas refuerzo soldadas a estante

50kg de **carga extra** por omega adicional.

DIM (mm)	REF	PVP(€)
800x40x30	IDP58108	<b>17</b>
1000x40x30	IDP58110	<b>23</b>
1200x40x30	IDP58112	<b>29</b>
1400x40x30	IDP58114	<b>35</b>



## ESTANTERÍAS DE PIE ALUMINIO POLIPROPILENO

- **Montantes** en aluminio anodizado, **estantes** de polietileno alimentario color gris.
- Sistema de **anclaje** sin herramientas.
- **Patas** regulables inferiores 30mm con rosca oculta.
- Medidas adaptadas a la norma **gastronorm**, lo que permite colocar los estantes o cubetas GN indistintamente.
- Muy **robustas y resistentes**: capacidad de carga 120Kg por nivel de estante hasta un máximo de 900Kg por conjunto de estantería y una resistencia térmica de -30° a +75°.



**Se suministran desmontadas**  
Rápido y fácil montaje



A. Estantería lineal

B. Estantería angular

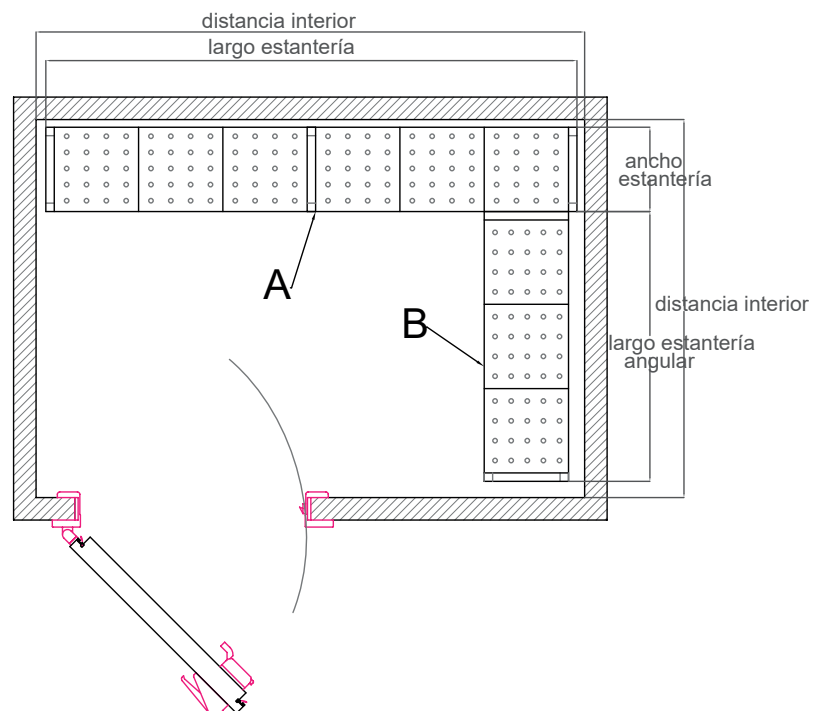
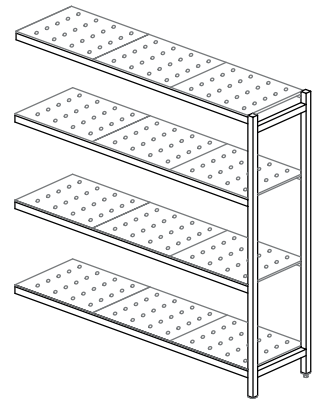
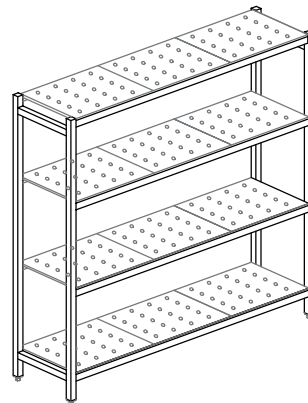

## BANCADAS DE ALUMINIO

- **Montantes y travesaños** en aluminio anodizado, **estante** de polietileno alimentario color gris.
- Sistema de **anclaje** sin herramientas.
- **Patas** regulables inferiores 30mm con rosca oculta.
- Muy **robustas y resistentes**, capacidad de carga 250 Kg y una resistencia térmica de -30° a +75°.



**Se suministran desmontadas**  
Rápido y fácil montaje



### Fondo 373 mm

DIM (mm)	REF	PVP(€)
862x373x280	IDP07603	168
950x373x280	IDP07604	180
1038x373x280	IDP07605	192
1126x373x280	IDP07606	204
1216x373x280	IDP07607	216
1304x373x280	IDP07608	228
1394x373x280	IDP07609	240
1569x373x280	IDP07610	252

### Fondo 577 mm

DIM (mm)	REF	PVP(€)
862x577x280	IDP07611	192
950x577x280	IDP07612	204
1038x577x280	IDP07613	216
1126x577x280	IDP07614	228
1216x577x280	IDP07615	240
1304x577x280	IDP07616	252
1394x577x280	IDP07617	264
1569x577x280	IDP07618	276

## ACCESORIOS Y RECAMBIOS

CARACTERÍSTICAS	REF	PVP(€)
Rueda sin freno 150h	1 IDP08150	24
Rueda con freno 150h	2 IDP09150	30
Tapón superior	3 IDP08100	1
Pie regulable	4 IDP08110	6
Par de tacos fijación estante	5 IDP08120	7
Unión lateral estantería 373	6 IDP08140	20
Unión lateral estantería 577	7 IDP08160	21

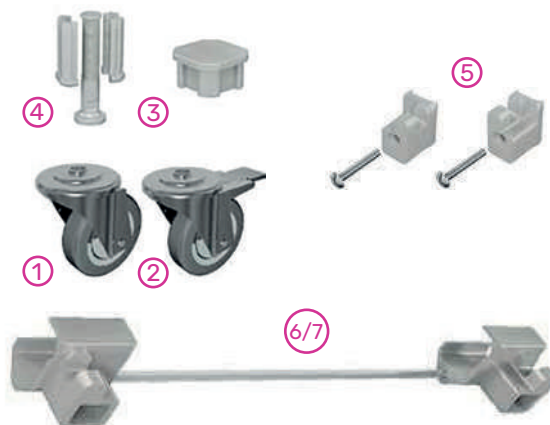

# ESTANTERÍAS ALUMINIO LINEALES ALTO 1700

07.



Se suministran desmontadas  
Rápido y fácil montaje



## Fondo 373 mm

LARGO (mm)	3 NIVELES	PVP (€)	4 NIVELES	PVP (€)	5 NIVELES	PVP (€)
596	IDP07000	306	IDP07047	354	IDP07094	396
684	IDP07001	312	IDP07048	366	IDP07095	408
772	IDP07002	330	IDP07049	384	IDP07096	420
862	IDP07003	342	IDP07050	396	IDP07097	438
950	IDP07004	348	IDP07051	408	IDP07098	450
1038	IDP07005	360	IDP07052	420	IDP07099	474
1126	IDP07006	378	IDP07053	444	IDP07100	492
1216	IDP07007	384	IDP07054	462	IDP07101	528
1304	IDP07008	402	IDP07055	486	IDP07102	558
1394	IDP07009	420	IDP07056	504	IDP07103	588
1569	IDP07010	462	IDP07057	564	IDP07104	666
1746	IDP07011	474	IDP07058	576	IDP07105	678
1834	IDP07012	486	IDP07059	588	IDP07106	696
1922	IDP07013	498	IDP07060	600	IDP07107	720
2010	IDP07014	618	IDP07061	744	IDP07108	870
2136	IDP07015	630	IDP07062	762	IDP07109	888
2224	IDP07016	648	IDP07063	822	IDP07110	912
2314	IDP07017	666	IDP07064	840	IDP07111	948
2404	IDP07018	690	IDP07065	858	IDP07112	966
2492	IDP07019	708	IDP07066	882	IDP07113	984
2580	IDP07020	726	IDP07067	906	IDP07114	1014
2670	IDP07021	738	IDP07068	918	IDP07115	1038
2760	IDP07022	804	IDP07069	942	IDP07116	1050
2845	IDP07023	846	IDP07070	990	IDP07117	1098
2935	IDP07024	858	IDP07071	1050	IDP07118	1170
3110	IDP07025	870	IDP07072	1068	IDP07119	1260
3287	IDP07026	882	IDP07073	1080	IDP07120	1290
3464	IDP07027	894	IDP07074	1098	IDP07121	1308
3552	IDP07028	906	IDP07075	1110	IDP07122	1326
3640	IDP07029	918	IDP07076	1122	IDP07123	1344
3728	IDP07030	936	IDP07077	1284	IDP07124	1380
3816	IDP07031	1044	IDP07078	1302	IDP07125	1518
3904	IDP07032	1068	IDP07079	1314	IDP07126	1536
3992	IDP07033	1080	IDP07080	1332	IDP07127	1566
4126	IDP07034	1092	IDP07081	1344	IDP07128	1578
4211	IDP07035	1104	IDP07082	1356	IDP07129	1596
4301	IDP07036	1116	IDP07083	1368	IDP07130	1614
4386	IDP07037	1140	IDP07084	1410	IDP07131	1680
4476	IDP07038	1188	IDP07085	1470	IDP07132	1758
4651	IDP07039	1230	IDP07086	1530	IDP07133	1829
4828	IDP07040	1242	IDP07087	1566	IDP07134	1860
5005	IDP07041	1254	IDP07088	1578	IDP07135	1884
5182	IDP07042	1266	IDP07089	1596	IDP07136	1914
5358	IDP07043	1278	IDP07090	1608	IDP07137	1944
5446	IDP07044	1290	IDP07091	1632	IDP07138	1962
5534	IDP07045	1302	IDP07092	1644	IDP07139	2004
5622	IDP07046	1320	IDP07093	1668	IDP07140	2034

## Fondo 577 mm

LARGO (mm)	3 NIVELES	PVP (€)	4 NIVELES	PVP (€)	5 NIVELES	PVP (€)
596	IDP07141	342	IDP07188	396	IDP07235	444
684	IDP07142	354	IDP07189	408	IDP07236	456
772	IDP07143	372	IDP07190	432	IDP07237	498
862	IDP07144	384	IDP07191	444	IDP07238	510
950	IDP07145	396	IDP07192	462	IDP07239	528
1038	IDP07146	408	IDP07193	474	IDP07240	540
1126	IDP07147	426	IDP07194	504	IDP07241	570
1216	IDP07148	444	IDP07195	522	IDP07242	600
1304	IDP07149	462	IDP07196	552	IDP07243	630
1394	IDP07150	480	IDP07197	576	IDP07244	672
1569	IDP07151	510	IDP07198	618	IDP07245	726
1746	IDP07152	528	IDP07199	642	IDP07246	744
1834	IDP07153	540	IDP07200	684	IDP07247	774
1922	IDP07154	552	IDP07201	714	IDP07248	804
2010	IDP07155	696	IDP07202	834	IDP07249	978
2136	IDP07156	714	IDP07203	852	IDP07250	1008
2224	IDP07157	726	IDP07204	882	IDP07251	1038
2314	IDP07158	744	IDP07205	912	IDP07252	1080
2404	IDP07159	762	IDP07206	930	IDP07253	1104
2492	IDP07160	786	IDP07207	948	IDP07254	1122
2580	IDP07161	804	IDP07208	978	IDP07255	1158
2670	IDP07162	834	IDP07209	1008	IDP07256	1188
2760	IDP07163	846	IDP07210	1020	IDP07257	1200
2845	IDP07164	864	IDP07211	1050	IDP07258	1224
2935	IDP07165	888	IDP07212	1080	IDP07259	1266
3110	IDP07166	906	IDP07213	1104	IDP07260	1296
3287	IDP07167	924	IDP07214	1128	IDP07261	1356
3464	IDP07168	948	IDP07215	1152	IDP07262	1386
3552	IDP07169	966	IDP07216	1170	IDP07263	1416
3640	IDP07170	984	IDP07217	1188	IDP07264	1428
3728	IDP07171	1002	IDP07218	1206	IDP07265	1446
3816	IDP07172	1026	IDP07219	1224	IDP07266	1464
3904	IDP07173	1062	IDP07220	1266	IDP07267	1488
3992	IDP07174	1188	IDP07221	1458	IDP07268	1734
4126	IDP07175	1206	IDP07222	1476	IDP07269	1764
4211	IDP07176	1224	IDP07223	1500	IDP07270	1806
4301	IDP07177	1236	IDP07224	1518	IDP07271	1836
4386	IDP07178	1254	IDP07225	1530	IDP07272	1860
4476	IDP07179	1272	IDP07226	1554	IDP07273	1884
4651	IDP07180	1290	IDP07227	1578	IDP07274	1914
4828	IDP07181	1320	IDP07228	1620	IDP07275	1932
5005	IDP07182	1344	IDP07229	1668	IDP07276	1986
5182	IDP07183	1356	IDP07230	1698	IDP07277	2016
5358	IDP07184	1374	IDP07231	1728	IDP07278	2040
5446	IDP07185	1386	IDP07232	1764	IDP07279	2076
5534	IDP07186	1404	IDP07233	1812	IDP07280	2154
5622	IDP07187	1434	IDP07234	1860	IDP07281	2208

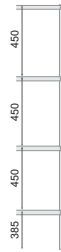

## ESTANTERÍAS ALUMINIO ANGULARES ALTO 1700

Se suministran desmontadas  
Rápido y fácil montaje



### Fondo 373 mm

### Fondo 577 mm

LARGO (mm)	3 NIVELES	PVP (€)	4 NIVELES	PVP (€)	5 NIVELES	PVP (€)
564	IDP07282	228	IDP07329	276	IDP07376	324
652	IDP07283	240	IDP07330	288	IDP07377	342
740	IDP07284	252	IDP07331	306	IDP07378	360
830	IDP07285	264	IDP07332	324	IDP07379	384
918	IDP07286	282	IDP07333	342	IDP07380	408
1006	IDP07287	294	IDP07334	366	IDP07381	432
1094	IDP07288	312	IDP07335	384	IDP07382	456
1184	IDP07289	324	IDP07336	402	IDP07383	480
1272	IDP07290	342	IDP07337	420	IDP07384	504
1362	IDP07291	450	IDP07338	552	IDP07385	648
1537	IDP07292	462	IDP07339	564	IDP07386	666
1714	IDP07293	474	IDP07340	582	IDP07387	690
1802	IDP07294	486	IDP07341	600	IDP07388	714
1890	IDP07295	498	IDP07342	618	IDP07389	738
1978	IDP07296	516	IDP07343	636	IDP07390	762
2104	IDP07297	528	IDP07344	660	IDP07391	786
2192	IDP07298	546	IDP07345	678	IDP07392	810
2282	IDP07299	558	IDP07346	702	IDP07393	840
2372	IDP07300	576	IDP07347	720	IDP07394	858
2460	IDP07301	588	IDP07348	738	IDP07395	882
2548	IDP07302	606	IDP07349	756	IDP07396	906
2638	IDP07303	618	IDP07350	774	IDP07397	930
2728	IDP07304	630	IDP07351	786	IDP07398	954
2813	IDP07305	648	IDP07352	798	IDP07399	978
2903	IDP07306	750	IDP07353	906	IDP07400	1110
3078	IDP07307	768	IDP07354	924	IDP07401	1140
3255	IDP07308	780	IDP07355	942	IDP07402	1164
3432	IDP07309	798	IDP07356	966	IDP07403	1188
3520	IDP07310	816	IDP07357	984	IDP07404	1212
3608	IDP07311	828	IDP07358	1002	IDP07405	1242
3696	IDP07312	840	IDP07359	1020	IDP07406	1266
3784	IDP07313	858	IDP07360	1068	IDP07407	1284
3872	IDP07314	870	IDP07361	1086	IDP07408	1308
3960	IDP07315	882	IDP07362	1110	IDP07409	1332
4094	IDP07316	900	IDP07363	1128	IDP07410	1356
4179	IDP07317	912	IDP07364	1146	IDP07411	1380
4269	IDP07318	930	IDP07365	1164	IDP07412	1404
4354	IDP07319	942	IDP07366	1188	IDP07413	1428
4444	IDP07320	960	IDP07367	1206	IDP07414	1452
4619	IDP07321	1062	IDP07368	1326	IDP07415	1590
4796	IDP07322	1080	IDP07369	1350	IDP07416	1620
4973	IDP07323	1098	IDP07370	1368	IDP07417	1644
5150	IDP07324	1110	IDP07371	1386	IDP07418	1668
5326	IDP07325	1122	IDP07372	1404	IDP07419	1692
5414	IDP07326	1134	IDP07373	1422	IDP07420	1710
5502	IDP07327	1152	IDP07374	1440	IDP07421	1734
5590	IDP07328	1188	IDP07375	1464	IDP07422	1764

LARGO (mm)	3 NIVELES	PVP (€)	4 NIVELES	PVP (€)	5 NIVELES	PVP (€)
564	IDP07423	252	IDP07470	300	IDP07517	348
652	IDP07424	264	IDP07471	318	IDP07518	372
740	IDP07425	282	IDP07472	342	IDP07519	396
830	IDP07426	300	IDP07473	366	IDP07520	432
918	IDP07427	318	IDP07474	390	IDP07521	462
1006	IDP07428	330	IDP07475	408	IDP07522	480
1094	IDP07429	348	IDP07476	432	IDP07523	510
1184	IDP07430	360	IDP07477	444	IDP07524	534
1272	IDP07431	378	IDP07478	474	IDP07525	564
1362	IDP07432	498	IDP07479	606	IDP07526	714
1537	IDP07433	516	IDP07480	630	IDP07527	744
1714	IDP07434	528	IDP07481	648	IDP07528	768
1802	IDP07435	546	IDP07482	672	IDP07529	798
1890	IDP07436	570	IDP07483	702	IDP07530	834
1978	IDP07437	588	IDP07484	726	IDP07531	864
2104	IDP07438	606	IDP07485	750	IDP07532	894
2192	IDP07439	618	IDP07486	768	IDP07533	912
2282	IDP07440	630	IDP07487	780	IDP07534	930
2372	IDP07441	648	IDP07488	804	IDP07535	960
2460	IDP07442	666	IDP07489	828	IDP07536	990
2548	IDP07443	678	IDP07490	846	IDP07537	1014
2638	IDP07444	690	IDP07491	864	IDP07538	1038
2728	IDP07445	708	IDP07492	888	IDP07539	1068
2813	IDP07446	726	IDP07493	912	IDP07540	1098
2903	IDP07447	858	IDP07494	1062	IDP07541	1266
3078	IDP07448	876	IDP07495	1086	IDP07542	1296
3255	IDP07449	894	IDP07496	1110	IDP07543	1326
3432	IDP07450	906	IDP07497	1128	IDP07544	1344
3520	IDP07451	918	IDP07498	1140	IDP07545	1362
3608	IDP07452	930	IDP07499	1158	IDP07546	1386
3696	IDP07453	942	IDP07500	1182	IDP07547	1416
3784	IDP07454	960	IDP07501	1206	IDP07548	1446
3872	IDP07455	978	IDP07502	1230	IDP07549	1476
3960	IDP07456	996	IDP07503	1242	IDP07550	1494
4094	IDP07457	1008	IDP07504	1260	IDP07551	1518
4179	IDP07458	1020	IDP07505	1278	IDP07552	1542
4269	IDP07459	1038	IDP07506	1308	IDP07553	1572
4354	IDP07460	1056	IDP07507	1332	IDP07554	1602
4444	IDP07461	1080	IDP07508	1356	IDP07555	1632
4619	IDP07462	1206	IDP07509	1500	IDP07556	1794
4796	IDP07463	1218	IDP07510	1518	IDP07557	1818
4973	IDP07464	1230	IDP07511	1530	IDP07558	1836
5150	IDP07465	1242	IDP07512	1554	IDP07559	1866
5326	IDP07466	1260	IDP07513	1578	IDP07560	1896
5414	IDP07467	1278	IDP07514	1602	IDP07561	1926
5502	IDP07468	1296	IDP07515	1626	IDP07562	1956
5590	IDP07469	1326	IDP07516	1644	IDP07563	1992



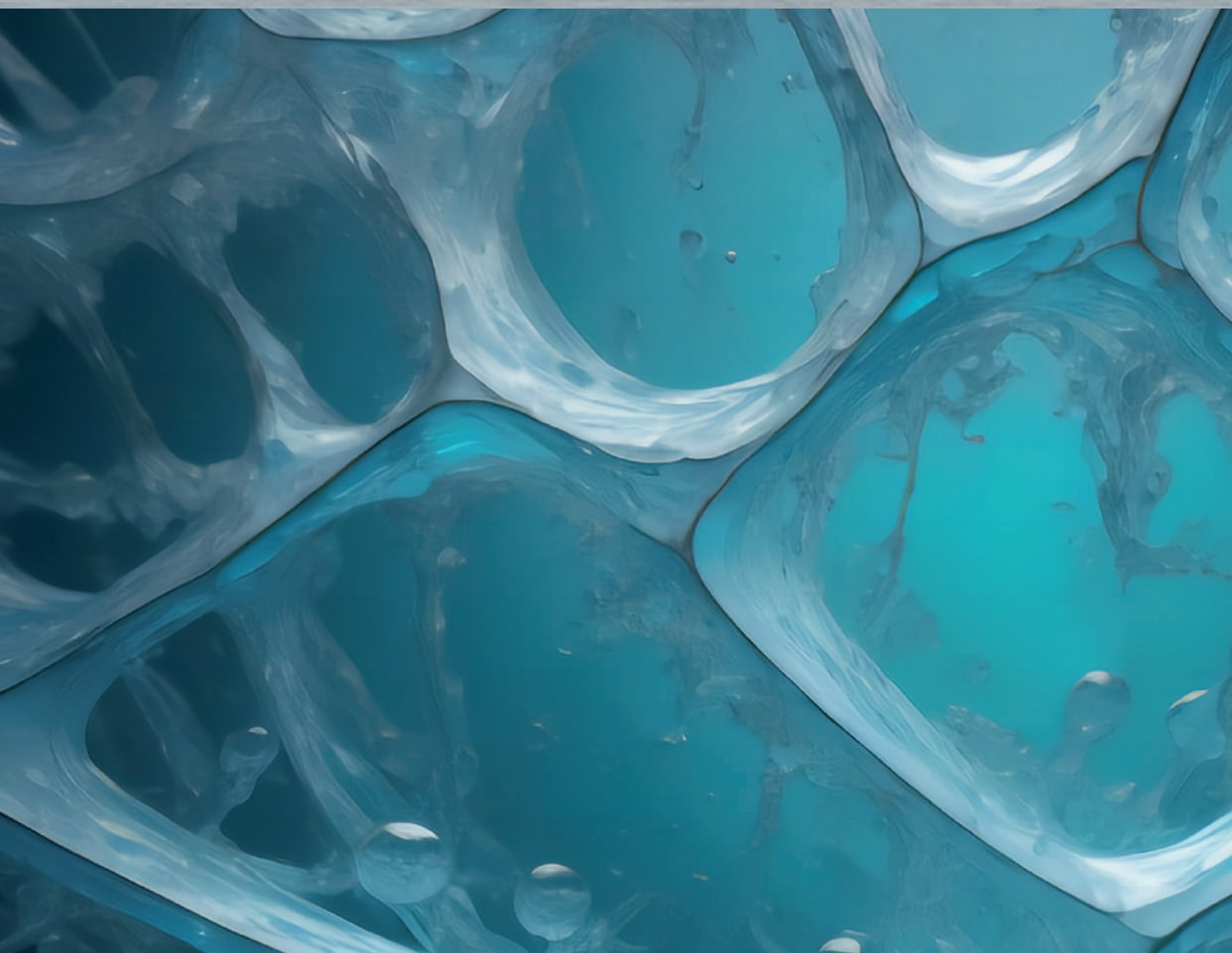

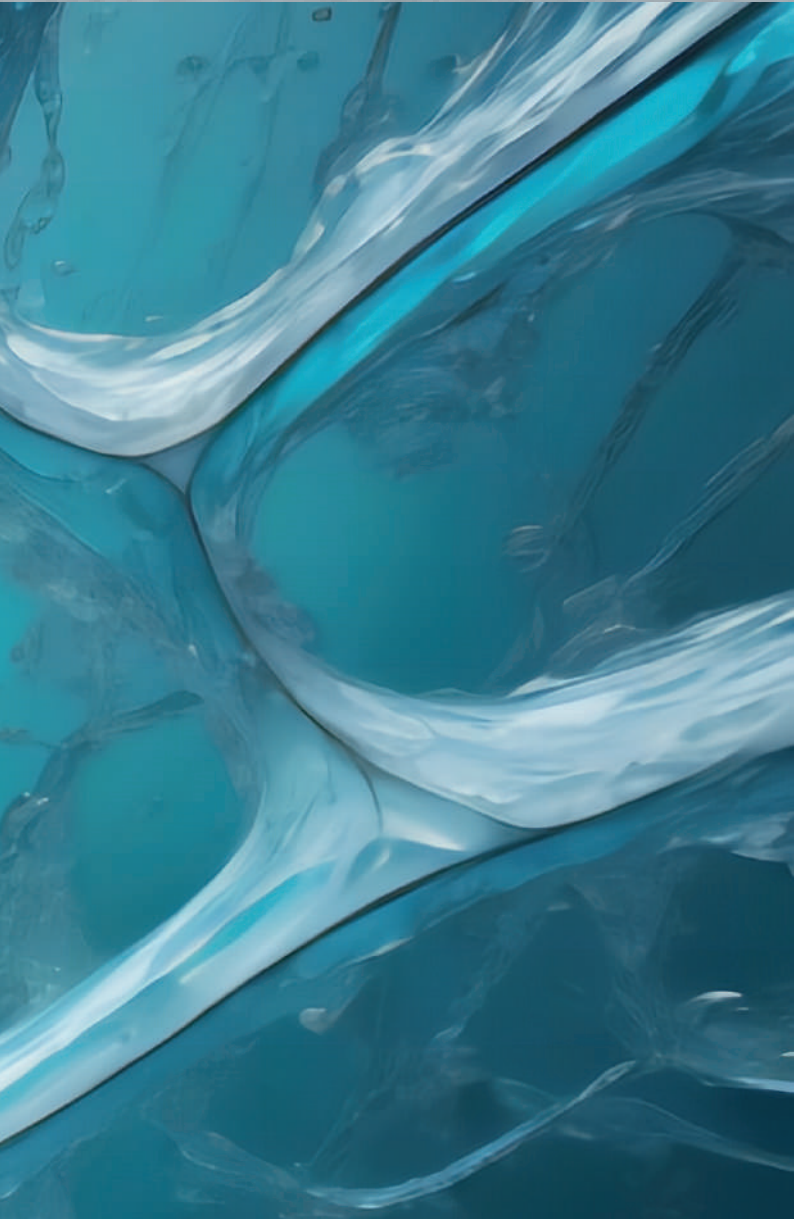

# 08.

- Cubetas GN
- Accesorios y complementos

## CUBETAS GN MEDIDAS Y COMBINACIONES

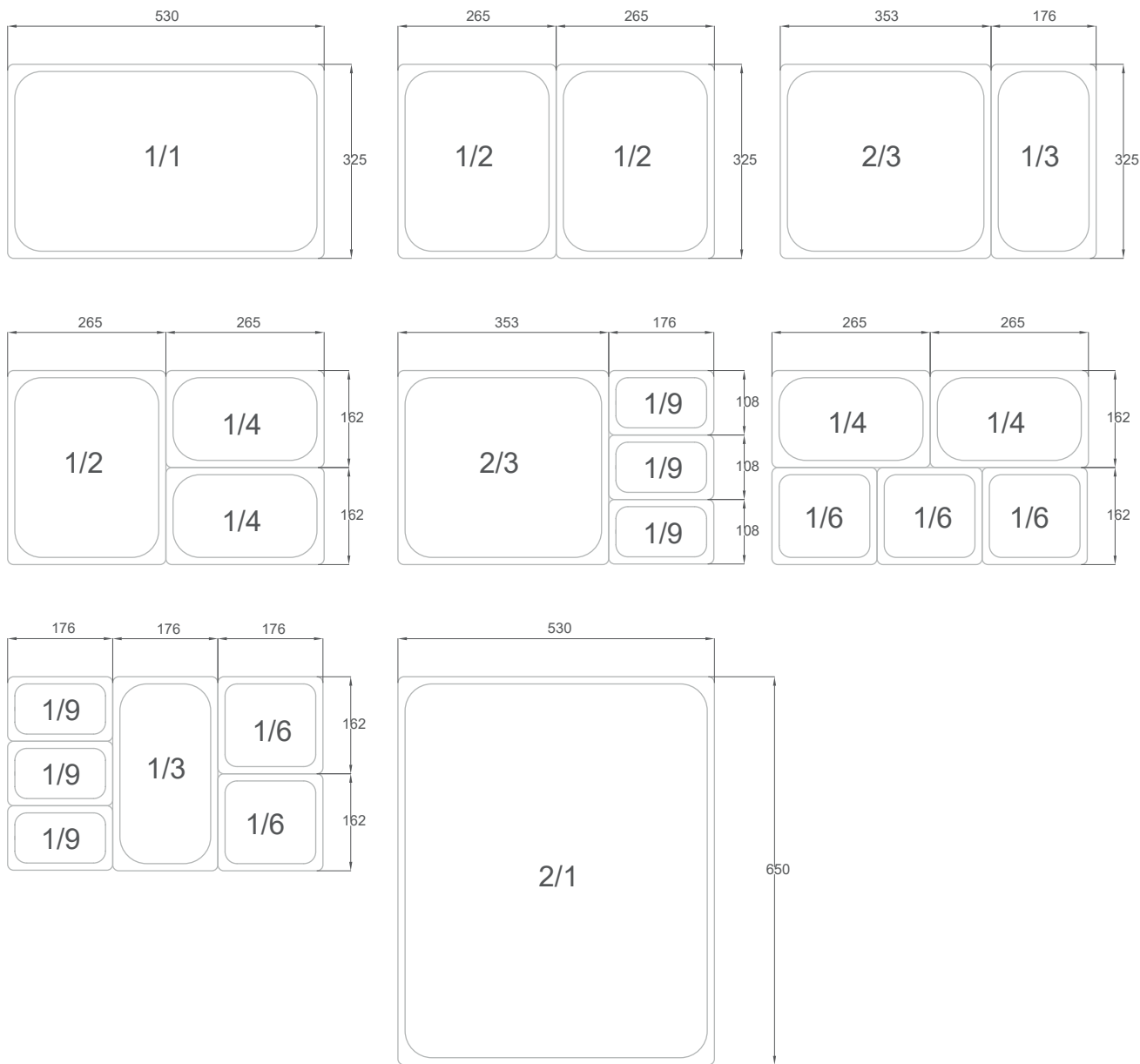

### Medidas encaste

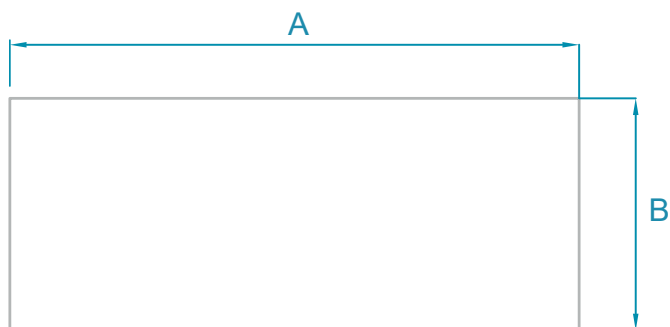

MODELO	A	B
2/1	630	510
1/1	510	305
2/3	333	305
1/2	305	245
1/3	305	155
1/4	245	142
1/6	156	142
1/9	156	88

- Cumplimiento de la norma sanitaria EN-631.2.
- Vértices con radios sanitarios.
- Bordes superiores reforzados.
- Recomendadas para presentación, almacenamiento y transporte de alimentos.

## GN 2/1

DIM (mm)	LITROS	REF	PVP (€)	REF. PERFORADAS	PVP (€)
650x530x20	6,2	IDGN21020	<b>38</b>	IDGP21020	<b>65</b>
650x530x40	11,5	IDGN21040	<b>41</b>	IDGP21040	<b>68</b>
650x530x65	18,8	IDGN21065	<b>49</b>	IDGP21065	<b>85</b>
650x530x100	28,9	IDGN21100	<b>55</b>	IDGP21100	<b>104</b>
650x530x150	43,1	IDGN21150	<b>86</b>	IDGP21150	<b>144</b>
650x530x200	52	IDGN21200	<b>96</b>	IDGP21200	<b>176</b>



## GN 1/1

DIM (mm)	LITROS	REF	PVP (€)	REF. PERFORADAS	PVP (€)
530x325x20	2,8	IDGN11020	<b>19</b>	IDGP11020	<b>43</b>
530x325x40	5,1	IDGN11040	<b>22</b>	IDGP11040	<b>47</b>
530x325x65	8,3	IDGN11065	<b>24</b>	IDGP11065	<b>53</b>
530x325x100	14,2	IDGN11100	<b>29</b>	IDGP11100	<b>65</b>
530x325x150	20,2	IDGN11150	<b>36</b>	IDGP11150	<b>96</b>
530x325x200	26	IDGN11200	<b>46</b>	IDGP11200	<b>110</b>



## GN 2/3

DIM (mm)	LITROS	REF	PVP (€)	REF. PERFORADAS	PVP (€)
353x325x20	1,7	IDGN23020	<b>16</b>	IDGP23020	<b>35</b>
353x325x40	3,1	IDGN23040	<b>18</b>	IDGP23040	<b>37</b>
353x325x65	5,6	IDGN23065	<b>20</b>	IDGP23065	<b>44</b>
353x325x100	8,8	IDGN23100	<b>24</b>	IDGP23100	<b>61</b>
353x325x150	13,2	IDGN23150	<b>38</b>	IDGP23150	<b>80</b>
353x325x200	18,3	IDGN23200	<b>48</b>	IDGP23200	<b>86</b>



## GN 1/2

DIM (mm)	LITROS	REF	PVP (€)	REF. PERFORADAS	PVP (€)
325x265x20	1,2	IDGN12020	<b>12</b>		
325x265x40	2,2	IDGN12040	<b>14</b>		
325x265x65	4,1	IDGN12065	<b>17</b>	IDGP12065	<b>40</b>
325x265x100	6,1	IDGN12100	<b>22</b>	IDGP12100	<b>48</b>
325x265x150	9,1	IDGN12150	<b>25</b>	IDGP12150	<b>62</b>
325x265x200	12	IDGN12200	<b>34</b>	IDGP12200	<b>78</b>



## GN 1/3

DIM (mm)	LITROS	REF	PVP (€)	REF. PERFORADAS	PVP (€)
325x176x20	0,8	IDGN13020	<b>11</b>	IDGP13020	<b>31</b>
325x176x40	1,5	IDGN13040	<b>13</b>	IDGP13040	<b>34</b>
325x176x65	2,5	IDGN13065	<b>14</b>	IDGP13065	<b>36</b>
325x176x100	3,8	IDGN13100	<b>18</b>	IDGP13100	<b>52</b>
325x176x150	5,6	IDGN13150	<b>26</b>	IDGP13150	<b>59</b>
325x176x200	7,3	IDGN13200	<b>35</b>	IDGP13200	<b>73</b>



## GN 1/4

DIM (mm)	LITROS	REF	PVP (€)
265x162x20	0,5	IDGN14020	<b>10</b>
265x162x65	1,7	IDGN14065	<b>12</b>
265x162x100	2,8	IDGN14100	<b>14</b>
265x162x150	4,1	IDGN14150	<b>23</b>
265x162x200	5	IDGN14200	<b>34</b>



## GN 1/6

DIM (mm)	LITROS	REF	PVP (€)
176x162x65	1	IDGN16065	<b>14</b>
176x162x100	1,6	IDGN16100	<b>16</b>
176x162x150	2,2	IDGN16150	<b>23</b>
176x162x200	2,9	IDGN16200	<b>30</b>



## GN 1/9

DIM (mm)	LITROS	REF	PVP (€)
176x108x65	0,6	IDGN19065	<b>10</b>
176x108x100	0,8	IDGN19100	<b>15</b>





## Tapas

Cubetas y tapas con asas consultar.

DIM (mm)	REF	PVP (€)
GN 1/1	IDGN1100T	25
GN 2/3	IDGN2300T	22
GN 1/2	IDGN1200T	16
GN 1/3	IDGN1300T	13
GN 1/4	IDGN1400T	11
GN 1/6	IDGN1600T	8
GN 1/9	IDGN1900T	7



## Perfiles divisorios

DIM (mm)	REF	PVP (€)
GN 1/1-530mm	IDGN11000	17
GN 1/2-325mm	IDGN12000	13
GN 1/3-176mm	IDGN13000	10



## Parrillas GN pastelería

DIM (mm)	TRAV.	VARILLA	REF	PVP (€)
GN 2/1 - 650x530	3 ud. 5ø	32 ud. 2ø	IDGNR021	42
GN 1/1 - 530x325	2 ud. 5ø	20 ud. 2ø	IDGNR011	30
GN2/1- 650x530	3 ud. 7ø	32ud. 4ø	IDGNR721	52
GN1/1- 530x325	2 ud. 7ø	20ud. 4ø	IDGNR711	41
GN 2/3 - 353x325	1 ud. 5ø	20 ud. 3ø	IDGNR023	22
Pastelera - 600x400	2 ud. 6ø	24 ud. 3ø	IDPR6040	46

Parrillas reforzadas



## Fondos perforados

DIM (mm)	REF	PVP (€)
GN 2/1	IDGN00021	102
GN 1/1	IDGN00011	54
GN 2/3	IDGN00023	46
GN 1/2	IDGN00012	30
GN 1/3	IDGN00013	23
GN 1/4	IDGN00014	19



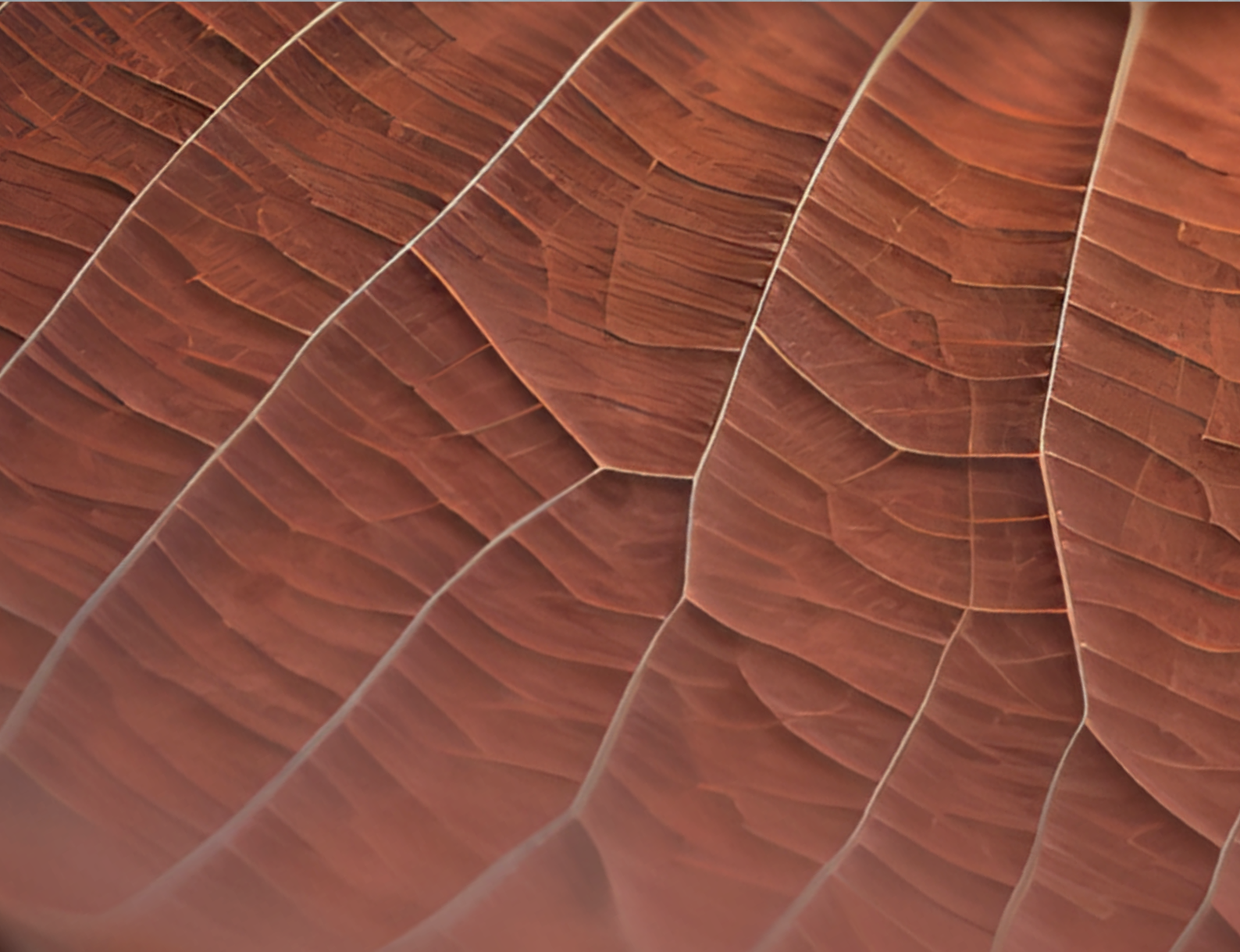

# 09.

- Muebles/módulos pasantes
- Muebles/módulos abiertos 1 cara
- Muebles/módulos puertas correderas
- Muebles abiertos 1 cara / 3 cajones
- Muebles puertas corr. 1 cara / 3 cajones
- Muebles/módulos puertas batientes
- Muebles/módulos puertas batientes y cajones
- Muebles reciclaje
- Muebles/módulos tolva y cajones
- Muebles/módulos cuerpo de guías
- Mueble apoyo terraza
- Mueble contenedor residuos
- Muebles/módulos cafeteros y contra mostradores
- Encimeras
- Armarios
- Accesorios



## MUEBLES/MÓDULOS NEUTROS PASANTES H.850

- Encimeras **reforzadas** con omegas.
- **Frontal** soldado de 60mm en punto redondo.
- **Estante** base con doble omega de refuerzo, estante regulable intermedio reforzado con omega central.
- **Puertas correderas** 2 caras con rodamiento superior de nylon.
- **Patas** cilíndricas de acero inoxidable 150mm regulables 50mm, 6 patas y **refuerzo** central a partir de 2000mm.

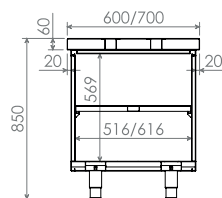

**Medidas especiales en gama flexi estándar páginas 208-209 y 212-213.**

### CENTRAL ABIERTO



### CENTRAL CORREDERAS



### MÓDULO ABIERTO



### MÓDULO CORREDERAS



### Fondo 600

DIM (mm)	REF	PVP (€)
600	IDN10606	776
800	IDN10608	805
1000	IDN10610	840
1200	IDN10612	897
1400	IDN10614	955
1500	IDN10615	989
1600	IDN10616	1024
1800	IDN10618	1104
2000	IDN10620	1173
2200	IDN10622	1294
2400	IDN10624	1380

### Fondo 700

DIM (mm)	REF	PVP (€)
600	IDN10706	834
800	IDN10708	857
1000	IDN10710	880
1200	IDN10712	937
1400	IDN10714	1001
1500	IDN10715	1029
1600	IDN10716	1058
1800	IDN10718	1133
2000	IDN10720	1219
2200	IDN10722	1346
2400	IDN10724	1438

DIM (mm)	REF	PVP (€)
1000	IDN13610	1282
1200	IDN13612	1374
1400	IDN13614	1461
1500	IDN13615	1535
1600	IDN13616	1599
1800	IDN13618	1731
2000	IDN13620	1823
2200	IDN13622	1926
2400	IDN13624	2018

DIM (mm)	REF	PVP (€)
1000	IDN13710	1323
1200	IDN13712	1415
1400	IDN13714	1495
1500	IDN13715	1581
1600	IDN13716	1668
1800	IDN13718	1760
2000	IDN13720	1834
2200	IDN13722	1961
2400	IDN13724	2053

DIM(mm)	REF	PVP (€)
600	IDNM0606	523
800	IDNM0608	535
1000	IDNM0610	558
1200	IDNM0612	633
1400	IDNM0614	713
1500	IDNM0615	748
1600	IDNM0616	794
1800	IDNM0618	851
2000	IDNM0620	903
2200	IDNM0622	960
2400	IDNM0624	1035

DIM(mm)	REF	PVP (€)
600	IDNM0706	529
800	IDNM0708	558
1000	IDNM0710	592
1200	IDNM0712	667
1400	IDNM0714	748
1500	IDNM0715	788
1600	IDNM0716	811
1800	IDNM0718	886
2000	IDNM0720	937
2200	IDNM0722	1024
2400	IDNM0724	1121

DIM (mm)	REF	PVP (€)
1000	IDNM3610	1035
1200	IDNM3612	1104
1400	IDNM3614	1185
1500	IDNM3615	1242
1600	IDNM3616	1277
1800	IDNM3618	1311
2000	IDNM3620	1403
2200	IDNM3622	1570
2400	IDNM3624	1633

DIM (mm)	REF	PVP (€)
1000	IDNM3710	1070
1200	IDNM3712	1133
1400	IDNM3714	1219
1500	IDNM3715	1254
1600	IDNM3716	1277
1800	IDNM3718	1346
2000	IDNM3720	1432
2200	IDNM3722	1622
2400	IDNM3724	1702

# 09.

Medidas especiales en gama flexi estándar páginas 208-209 y 212-213.

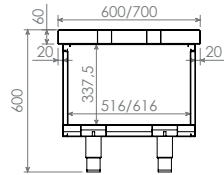

## MUEBLES/MÓDULOS NEUTROS PASANTES H.600

- Encimeras **reforzadas** con omegas.
- **Frontal** soldado de 60mm en punto redondo.
- **Estante** base con doble omega de refuerzo.
- **Puertas correderas** 2 caras con rodamiento superior de nylon.
- **Patas** cilíndricas de acero inoxidable 150mm regulables 50mm, 6 patas y **refuerzo** central a partir de 2000mm.

### Fondo 600

DIM (mm)	REF	PVP (€)
600	IDN60606	679
800	IDN60608	707
1000	IDN60610	742
1200	IDN60612	799
1400	IDN60614	857
1500	IDN60615	891
1600	IDN60616	926
1800	IDN60618	1001
2000	IDN60620	1070
2200	IDN60622	1185
2400	IDN60624	1271

DIM (mm)	REF	PVP (€)
1000	IDN63610	1185
1200	IDN63612	1277
1400	IDN63614	1357
1500	IDN63615	1432
1600	IDN63616	1495
1800	IDN63618	1622
2000	IDN63620	1714
2200	IDN63622	1817
2400	IDN63624	1903

DIM (mm)	REF	PVP (€)
600	IDNM0066	472
800	IDNM0806	483
1000	IDNM1006	500
1200	IDNM1206	569
1400	IDNM1406	644
1500	IDNM1506	673
1600	IDNM6106	713
1800	IDNM1806	765
2000	IDNM2006	811
2200	IDNM2206	863
2400	IDNM2406	932

DIM (mm)	REF	PVP (€)
1000	IDNM1036	932
1200	IDNM1236	995
1400	IDNM1436	1070
1500	IDNM1536	1098
1600	IDNM1636	1139
1800	IDNM1836	1179
2000	IDNM2036	1277
2200	IDNM2236	1415
2400	IDNM2436	1472

### Fondo 700

DIM (mm)	REF	PVP (€)
600	IDN60706	736
800	IDN60708	759
1000	IDN60710	782
1200	IDN60712	840
1400	IDN60714	897
1500	IDN60715	926
1600	IDN60716	955
1800	IDN60718	1029
2000	IDN60720	1110
2200	IDN60722	1236
2400	IDN60724	1328

DIM (mm)	REF	PVP (€)
1000	IDN63710	1225
1200	IDN63712	1311
1400	IDN63714	1392
1500	IDN63715	1472
1600	IDN63716	1558
1800	IDN63718	1650
2000	IDN63720	1725
2200	IDN63722	1852
2400	IDN63724	1944

DIM (mm)	REF	PVP (€)
600	IDNM0607	483
800	IDNM0807	500
1000	IDNM1007	541
1200	IDNM1207	598
1400	IDNM1407	673
1500	IDNM1507	707
1600	IDNM1607	730
1800	IDNM1807	799
2000	IDNM2007	845
2200	IDNM2207	920
2400	IDNM2407	1006

DIM (mm)	REF	PVP (€)
1000	IDNM1037	960
1200	IDNM1237	1018
1400	IDNM1437	1098
1500	IDNM1537	1127
1600	IDNM1637	1150
1800	IDNM1837	1213
2000	IDNM2037	1288
2200	IDNM2237	1461
2400	IDNM2437	1530

#### CENTRAL ABIERTO



#### CENTRAL CORREDERAS



#### MÓDULO ABIERTO



#### MÓDULO CORREDERAS





## MUEBLES/MÓDULOS NEUTROS ABIERTOS 1 CARA H.850

- Encimeras **reforzadas** con omegas.
- **Frontal** soldado de 60mm en punto redondo, **peto** posterior soldados de 100mm con radio sanitario.
- **Estante** base con doble omega de refuerzo, estante regulable intermedio reforzado con omega central.
- **Patas** cilíndricas de acero inox 150mm regulables 50mm, 6 patas y **refuerzo** central a partir de 2000mm.

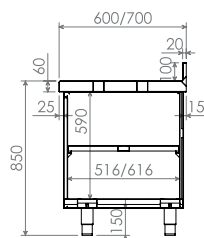

# 09.

Medidas especiales en gama  
flexi estándar páginas  
208, 212 y 216.

### MURAL ABIERTO



DIM (mm)	REF	PVP (€)
600	IDN01606	909
800	IDN01608	943
1000	IDN01610	978
1200	IDN01612	1018
1400	IDN01614	1075
1500	IDN01615	1116
1600	IDN01616	1156
1800	IDN01618	1219
2000	IDN01620	1340
2200	IDN01622	1443
2400	IDN01624	1547

### Fondo 700

DIM (mm)	REF	PVP (€)
600	IDN01706	926
800	IDN01708	960
1000	IDN01710	1001
1200	IDN01712	1064
1400	IDN01714	1116
1500	IDN01715	1150
1600	IDN01716	1208
1800	IDN01718	1271
2000	IDN01720	1380
2200	IDN01722	1489
2400	IDN01724	1593

### CENTRAL ABIERTO



DIM (mm)	REF	PVP (€)
600	IDN11606	845
800	IDN11608	880
1000	IDN11610	914
1200	IDN11612	955
1400	IDN11614	1012
1500	IDN11615	1052
1600	IDN11616	1093
1800	IDN11618	1156
2000	IDN11620	1277
2200	IDN11622	1380
2400	IDN11624	1484

DIM (mm)	REF	PVP (€)
600	IDN11706	863
800	IDN11708	897
1000	IDN11710	937
1200	IDN11712	1001
1400	IDN11714	1052
1500	IDN11715	1087
1600	IDN11716	1144
1800	IDN11718	1208
2000	IDN11720	1317
2200	IDN11722	1426
2400	IDN11724	1530

### MÓDULO ABIERTO



DIM (mm)	REF	PVP (€)
600	IDNM1606	569
800	IDNM1608	592
1000	IDNM1610	621
1200	IDNM1612	696
1400	IDNM1614	788
1500	IDNM1615	822
1600	IDNM1616	868
1800	IDNM1618	926
2000	IDNM1620	983
2200	IDNM1622	1052
2400	IDNM1624	1127

DIM (mm)	REF	PVP (€)
600	IDNM1706	598
800	IDNM1708	621
1000	IDNM1710	656
1200	IDNM1712	730
1400	IDNM1714	817
1500	IDNM1715	863
1600	IDNM1716	891
1800	IDNM1718	966
2000	IDNM1720	1018
2200	IDNM1722	1110
2400	IDNM1724	1202

# 09.

Medidas especiales en gama flexi estándar páginas 208, 212 y 216.

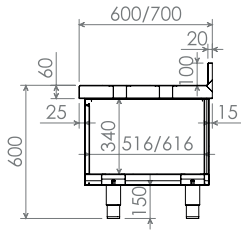

## MUEBLES/MÓDULOS NEUTROS ABIERTOS 1 CARA H.600

- Encimeras **reforzadas** con omegas.
- **Frontal** soldado de 60mm en punto redondo, **peto** posterior soldados de 100mm con radio sanitario.
- **Estante** base con doble omega de refuerzo.
- **Patas** cilíndricas de acero inox 150mm regulables 50mm, 6 patas y **refuerzo** central a partir de 2000mm.

### Fondo 600

DIM (mm)	REF	PVP (€)
600	IDN50606	811
800	IDN50608	845
1000	IDN50610	880
1200	IDN50612	920
1400	IDN50614	972
1500	IDN50615	1012
1600	IDN50616	1052
1800	IDN50618	1116
2000	IDN50620	1231
2200	IDN50622	1334
2400	IDN50624	1438

### Fondo 700

DIM (mm)	REF	PVP (€)
600	IDN50706	828
800	IDN50708	863
1000	IDN50710	903
1200	IDN50712	960
1400	IDN50714	1012
1500	IDN50715	1047
1600	IDN50716	1104
1800	IDN50718	1167
2000	IDN50720	1277
2200	IDN50722	1380
2400	IDN50724	1484

### MURAL ABIERTO



### CENTRAL ABIERTO



### MÓDULO ABIERTO



DIM (mm)	REF	PVP (€)
600	IDN61606	748
800	IDN61608	782
1000	IDN61610	817
1200	IDN61612	857
1400	IDN61614	909
1500	IDN61615	949
1600	IDN61616	989
1800	IDN61618	1052
2000	IDN61620	1167
2200	IDN61622	1271
2400	IDN61624	1374

DIM (mm)	REF	PVP (€)
600	IDN61706	765
800	IDN61708	799
1000	IDN61710	840
1200	IDN61712	897
1400	IDN61714	949
1500	IDN61715	983
1600	IDN61716	1041
1800	IDN61718	1104
2000	IDN61720	1213
2200	IDN61722	1317
2400	IDN61724	1420

DIM (mm)	REF	PVP (€)
600	IDNM0106	512
800	IDNM0816	535
1000	IDNM1016	558
1200	IDNM1216	627
1400	IDNM1416	707
1500	IDNM1516	742
1600	IDNM0166	782
1800	IDNM1816	834
2000	IDNM2016	886
2200	IDNM2216	949
2400	IDNM2416	1018

DIM (mm)	REF	PVP (€)
600	IDNM0617	535
800	IDNM0817	558
1000	IDNM1017	592
1200	IDNM1217	656
1400	IDNM1417	736
1500	IDNM1517	776
1600	IDNM1617	805
1800	IDNM1817	868
2000	IDNM2017	914
2200	IDNM2217	1001
2400	IDNM2417	1081

## MUEBLES/MÓDULOS NEUTROS PUERTAS CORREDERAS H.850

- Encimeras **reforzadas** con omegas.
- **Frontal** soldado de 60mm en punto redondo, **peto** posterior soldados de 100mm con radio sanitario.
- **Estante** base con doble omega de refuerzo, estante regulable intermedio reforzado con omega central.
- **Puertas correderas** 1 cara con rodamiento superior de nylon.
- **Patas** cilíndricas de acero inox 150mm regulables 50mm, 6 patas y **refuerzo** central a partir de 2000mm.

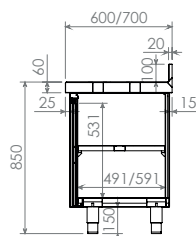

# 09.

Medidas especiales en gama  
flexi estándar páginas  
209, 213 y 216.

### Fondo 600

### Fondo 700

#### MURAL CORREDERAS



DIM (mm)	REF	PVP (€)
1000	IDN02610	1271
1200	IDN02612	1328
1400	IDN02614	1386
1500	IDN02615	1438
1600	IDN02616	1489
1800	IDN02618	1593
2000	IDN02620	1702
2200	IDN02622	1846
2400	IDN02624	1995

DIM (mm)	REF	PVP (€)
1000	IDN02710	1323
1200	IDN02712	1392
1400	IDN02714	1455
1500	IDN02715	1507
1600	IDN02716	1558
1800	IDN02718	1668
2000	IDN02720	1783
2200	IDN02722	1857
2400	IDN02724	2013

#### CENTRAL CORREDERAS



DIM (mm)	REF	PVP (€)
1000	IDN12610	1208
1200	IDN12612	1265
1400	IDN12614	1323
1500	IDN12615	1374
1600	IDN12616	1426
1800	IDN12618	1530
2000	IDN12620	1639
2200	IDN12622	1783
2400	IDN12624	1932

DIM (mm)	REF	PVP (€)
1000	IDN12710	1259
1200	IDN12712	1328
1400	IDN12714	1392
1500	IDN12715	1443
1600	IDN12716	1495
1800	IDN12718	1604
2000	IDN12720	1719
2200	IDN12722	1794
2400	IDN12724	1949

#### MÓDULO CORREDERAS



DIM (mm)	REF	PVP (€)
1000	IDNM2610	886
1200	IDNM2612	960
1400	IDNM2614	1052
1500	IDNM2615	1087
1600	IDNM2616	1133
1800	IDNM2618	1190
2000	IDNM2620	1271
2200	IDNM2622	1397
2400	IDNM2624	1472

DIM (mm)	REF	PVP (€)
1000	IDNM2710	920
1200	IDNM2712	995
1400	IDNM2714	1081
1500	IDNM2715	1127
1600	IDNM2716	1156
1800	IDNM2718	1231
2000	IDNM2720	1305
2200	IDNM2722	1455
2400	IDNM2724	1547

# 09.

Medidas especiales en gama flexi estándar páginas 209, 213 y 216.

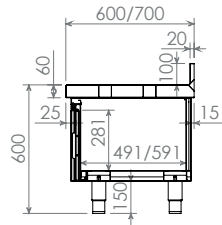

## MUEBLES/MÓDULOS NEUTROS PUERTAS CORREDERAS H.600

- Encimeras **reforzadas** con omegas.
- **Frontal** soldado de 60mm en punto redondo, **peto** posterior soldados de 100mm con radio sanitario.
- **Estante** base con doble omega de refuerzo.
- **Puertas correderas** 1 cara con rodamiento superior de nylon.
- **Patas** cilíndricas de acero inox 150mm regulables 50mm, 6 patas y **refuerzo** central a partir de 2000mm.

### Fondo 600

DIM (mm)	REF	PVP (€)
1000	IDN51610	1167
1200	IDN51612	1225
1400	IDN51614	1277
1500	IDN51615	1328
1600	IDN51616	1380
1800	IDN51618	1484
2000	IDN51620	1587
2200	IDN51622	1731
2400	IDN51624	1875

### Fondo 700

DIM (mm)	REF	PVP (€)
1000	IDN51710	1219
1200	IDN51712	1282
1400	IDN51714	1346
1500	IDN51715	1397
1600	IDN51716	1449
1800	IDN51718	1553
2000	IDN51720	1668
2200	IDN51722	1742
2400	IDN51724	1892

### MURAL CORREDERAS



DIM (mm)	REF	PVP (€)
1000	IDN62610	1104
1200	IDN62612	1162
1400	IDN62614	1213
1500	IDN62615	1265
1600	IDN62616	1317
1800	IDN62618	1420
2000	IDN62620	1524
2200	IDN62622	1668
2400	IDN62624	1811

DIM (mm)	REF	PVP (€)
1000	IDN62710	1156
1200	IDN62712	1219
1400	IDN62714	1282
1500	IDN62715	1334
1600	IDN62716	1386
1800	IDN62718	1489
2000	IDN62720	1604
2200	IDN62722	1679
2400	IDN62724	1829

### CENTRAL CORREDERAS



DIM (mm)	REF	PVP (€)
1000	IDNM1026	799
1200	IDNM1226	863
1400	IDNM1426	949
1500	IDNM1526	978
1600	IDNM1626	1018
1800	IDNM1826	1070
2000	IDNM2026	1144
2200	IDNM2226	1259
2400	IDNM2426	1328

DIM (mm)	REF	PVP (€)
1000	IDNM1027	828
1200	IDNM1227	897
1400	IDNM1427	972
1500	IDNM1527	1018
1600	IDNM2727	1041
1800	IDNM1827	1110
2000	IDNM2027	1173
2200	IDNM2227	1311
2400	IDNM2427	1392

### MÓDULO CORREDERAS



## MUEBLES NEUTROS ABIERTOS 1 CARA/3 CAJONES H.850

- Encimeras **reforzadas** con omegas.
- **Frontal** soldado de 60mm en punto redondo, **peto** posterior soldado de 100mm con radio sanitario.
- **Estante** base con doble omega de refuerzo, estante intermedio reforzado con omega central.
- **Cajones** con guías telescópicas.
- **Patas** cilíndricas de acero inox 150mm regulables 50mm, 6 patas y **refuerzo** central a partir de 2000mm.

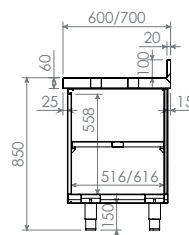

### Fondo 600

### Fondo 700

#### MURAL ABIERTO CAJONES DERECHA



DIM (mm)	REF	PVP (€)
1200	IDN0612D	1840
1400	IDN0614D	1880
1500	IDN0615D	1944
1600	IDN0616D	1978
1800	IDN0618D	1995
2000	IDN0620D	2047
2200	IDN0622D	2122
2400	IDN0624D	2191

DIM (mm)	REF	PVP (€)
1200	IDN0712D	1926
1400	IDN0714D	1967
1500	IDN0715D	2036
1600	IDN0716D	2070
1800	IDN0718D	2093
2000	IDN0720D	2145
2200	IDN0722D	2220
2400	IDN0724D	2294

#### MURAL ABIERTO CAJONES IZQUIERDA



DIM (mm)	REF	PVP (€)
1200	IDN0612I	1840
1400	IDN0614I	1880
1500	IDN0615I	1944
1600	IDN0616I	1978
1800	IDN0618I	1995
2000	IDN0620I	2047
2200	IDN0622I	2122
2400	IDN0624I	2191

DIM (mm)	REF	PVP (€)
1200	IDN0712I	1926
1400	IDN0714I	1967
1500	IDN0715I	2036
1600	IDN0716I	2070
1800	IDN0718I	2093
2000	IDN0720I	2145
2200	IDN0722I	2220
2400	IDN0724I	2294

#### CENTRAL ABIERTO CAJONES DERECHA



DIM (mm)	REF	PVP (€)
1200	IDN1612D	1777
1400	IDN1614D	1817
1500	IDN1615D	1880
1600	IDN1616D	1915
1800	IDN1618D	1932
2000	IDN1620D	1984
2200	IDN1622D	2059
2400	IDN1624D	2128

DIM (mm)	REF	PVP (€)
1200	IDN1712D	1863
1400	IDN1714D	1903
1500	IDN1715D	1972
1600	IDN1716D	2007
1800	IDN1718D	2030
2000	IDN1720D	2082
2200	IDN1722D	2156
2400	IDN1724D	2231

#### CENTRAL ABIERTO CAJONES IZQUIERDA



DIM (mm)	REF	PVP (€)
1200	IDN1612I	1777
1400	IDN1614I	1817
1500	IDN1615I	1880
1600	IDN1616I	1915
1800	IDN1618I	1932
2000	IDN1620I	1984
2200	IDN1622I	2059
2400	IDN1624I	2128

DIM (mm)	REF	PVP (€)
1200	IDN1712I	1863
1400	IDN1714I	1903
1500	IDN1715I	1972
1600	IDN1716I	2007
1800	IDN1718I	2030
2000	IDN1720I	2082
2200	IDN1722I	2156
2400	IDN1724I	2231



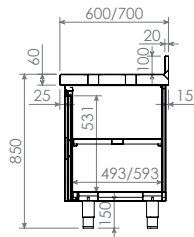

## MUEBLES NEUTROS PUERTAS CORREDERAS 1 CARA/3 CAJONES H.850

- Encimeras **reforzadas** con omegas.
- **Frontal** soldado de 60mm en punto redondo, **peto** posterior soldado de 100mm con radio sanitario.
- **Estante** base con doble omega de refuerzo, estante intermedio reforzado con omega central.
- **Puertas correderas** 1 cara con rodamiento superior de nylon.
- **Cajones** con guías telescópicas.
- **Patas** cilíndricas de acero inox 150mm regulables 50mm, 6 patas y **refuerzo** central a partir de 2000mm.

### Fondo 600

DIM (mm)	REF	PVP (€)
1200	IDN2612D	<b>2122</b>
1400	IDN2614D	<b>2162</b>
1500	IDN2615D	<b>2225</b>
1600	IDN2616D	<b>2260</b>
1800	IDN2618D	<b>2312</b>
2000	IDN2620D	<b>2363</b>
2200	IDN2622D	<b>2438</b>
2400	IDN2624D	<b>2507</b>

### Fondo 700

DIM (mm)	REF	PVP (€)
1200	IDN2712D	<b>2208</b>
1400	IDN2714D	<b>2248</b>
1500	IDN2715D	<b>2317</b>
1600	IDN2716D	<b>2352</b>
1800	IDN2718D	<b>2409</b>
2000	IDN2720D	<b>2461</b>
2200	IDN2722D	<b>2536</b>
2400	IDN2724D	<b>2611</b>

### MURAL CORREDERAS CAJONES DERECHA



### MURAL CORREDERAS CAJONES IZQUIERDA



DIM (mm)	REF	PVP (€)
1200	IDN2612I	<b>2122</b>
1400	IDN2614I	<b>2162</b>
1500	IDN2615I	<b>2225</b>
1600	IDN2616I	<b>2260</b>
1800	IDN2618I	<b>2312</b>
2000	IDN2620I	<b>2363</b>
2200	IDN2622I	<b>2438</b>
2400	IDN2624I	<b>2507</b>

DIM (mm)	REF	PVP (€)
1200	IDN2712I	<b>2208</b>
1400	IDN2714I	<b>2248</b>
1500	IDN2715I	<b>2317</b>
1600	IDN2716I	<b>2352</b>
1800	IDN2718I	<b>2409</b>
2000	IDN2720I	<b>2461</b>
2200	IDN2722I	<b>2536</b>
2400	IDN2724I	<b>2611</b>

### CENTRAL CORREDERAS CAJONES DERECHA



DIM (mm)	REF	PVP (€)
1200	IDN3612D	<b>2059</b>
1400	IDN3614D	<b>2099</b>
1500	IDN3615D	<b>2162</b>
1600	IDN3616D	<b>2197</b>
1800	IDN3618D	<b>2248</b>
2000	IDN3620D	<b>2300</b>
2200	IDN3622D	<b>2375</b>
2400	IDN3624D	<b>2444</b>

DIM (mm)	REF	PVP (€)
1200	IDN3712D	<b>2145</b>
1400	IDN3714D	<b>2185</b>
1500	IDN3715D	<b>2254</b>
1600	IDN3716D	<b>2289</b>
1800	IDN3718D	<b>2346</b>
2000	IDN3720D	<b>2398</b>
2200	IDN3722D	<b>2473</b>
2400	IDN3724D	<b>2547</b>

### CENTRAL CORREDERAS CAJONES IZQUIERDA



DIM (mm)	REF	PVP (€)
1200	IDN3612I	<b>2059</b>
1400	IDN3614I	<b>2099</b>
1500	IDN3615I	<b>2162</b>
1600	IDN3616I	<b>2197</b>
1800	IDN3618I	<b>2248</b>
2000	IDN3620I	<b>2300</b>
2200	IDN3622I	<b>2375</b>
2400	IDN3624I	<b>2444</b>

DIM (mm)	REF	PVP (€)
1200	IDN3712I	<b>2145</b>
1400	IDN3714I	<b>2185</b>
1500	IDN3715I	<b>2254</b>
1600	IDN3716I	<b>2289</b>
1800	IDN3718I	<b>2346</b>
2000	IDN3720I	<b>2398</b>
2200	IDN3722I	<b>2473</b>
2400	IDN3724I	<b>2547</b>

## MUEBLES/MÓDULOS NEUTROS PUERTAS BATIENTES H.850

- Encimeras **reforzadas** con omegas.
- **Frontal** soldado de 60mm en punto redondo, **peto** posterior soldados de 100mm con radio sanitario.
- **Estante** base con doble omega de refuerzo, estante intermedio reforzado con omega central.
- **Puertas batientes** 1 cara con bisagra vertical pivotante.
- **Patas** cilíndricas de acero inox 150mm regulables 50mm, 6 patas y **refuerzo** central a partir de 2000mm.

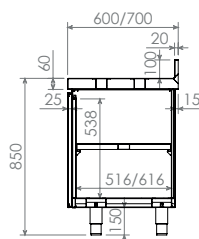

# 09.

Medidas especiales en  
gama flexi estándar  
páginas 214 i 217.

### Fondo 600

### Fondo 700

#### MURAL BATIENTES



DIM (mm)	REF	PVP (€)
600	IDN04606 1P	<b>983</b>
800	IDN04608 2P	<b>1219</b>
1000	IDN04610 2P	<b>1311</b>
1200	IDN04612 2P	<b>1380</b>
1400	IDN04614 3P	<b>1461</b>
1500	IDN04615 3P	<b>1524</b>
1600	IDN04616 3P	<b>1604</b>
1800	IDN04618 4P	<b>1708</b>
2000	IDN04620 4P	<b>1800</b>
2200	IDN04622 4P	<b>1955</b>
2400	IDN04624 4P	<b>2047</b>

DIM (mm)	REF	PVP (€)
600	IDN04706 1P	<b>1035</b>
800	IDN04708 2P	<b>1271</b>
1000	IDN04710 2P	<b>1363</b>
1200	IDN04712 2P	<b>1432</b>
1400	IDN04714 3P	<b>1518</b>
1500	IDN04715 3P	<b>1593</b>
1600	IDN04716 3P	<b>1656</b>
1800	IDN04718 4P	<b>1760</b>
2000	IDN04720 4P	<b>1863</b>
2200	IDN04722 4P	<b>2041</b>
2400	IDN04724 4P	<b>2122</b>

#### CENTRAL BATIENTES



DIM (mm)	REF	PVP (€)
600	IDN14606 1P	<b>937</b>
800	IDN14608 2P	<b>1173</b>
1000	IDN14610 2P	<b>1265</b>
1200	IDN14612 2P	<b>1334</b>
1400	IDN14614 3P	<b>1415</b>
1500	IDN14615 3P	<b>1478</b>
1600	IDN14616 3P	<b>1558</b>
1800	IDN14618 4P	<b>1662</b>
2000	IDN14620 4P	<b>1754</b>
2200	IDN14622 4P	<b>1909</b>
2400	IDN14624 4P	<b>2001</b>

DIM (mm)	REF	PVP (€)
600	IDN14706 1P	<b>989</b>
800	IDN14708 2P	<b>1225</b>
1000	IDN14710 2P	<b>1317</b>
1200	IDN14712 2P	<b>1386</b>
1400	IDN14714 3P	<b>1472</b>
1500	IDN14715 3P	<b>1547</b>
1600	IDN14716 3P	<b>1610</b>
1800	IDN14718 4P	<b>1714</b>
2000	IDN14720 4P	<b>1817</b>
2200	IDN14722 4P	<b>1995</b>
2400	IDN14724 4P	<b>2076</b>

#### MÓDULO BATIENTES



DIM (mm)	REF	PVP (€)
400	IDNM4604 1P	<b>581</b>
500	IDNM4605 1P	<b>615</b>
600	IDNM4606 1P	<b>661</b>
800	IDNM4608 2P	<b>891</b>
1000	IDNM4610 2P	<b>978</b>
1200	IDNM4612 2P	<b>1029</b>

DIM (mm)	REF	PVP (€)
400	IDNM4704 1P	<b>604</b>
500	IDNM4705 1P	<b>638</b>
600	IDNM4706 1P	<b>684</b>
800	IDNM4708 2P	<b>932</b>
1000	IDNM4710 2P	<b>1012</b>
1200	IDNM4712 2P	<b>1058</b>

# 09.

Medidas especiales en gama flexi estándar páginas 214 y 217.

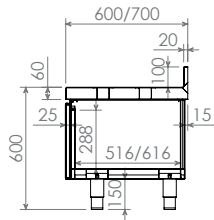

## MUEBLES/MÓDULOS NEUTROS PUERTAS BATIENTES H.600

- Encimeras **reforzadas** con omegas.
- **Frontal** soldado de 60mm en punto redondo, **peto** posterior soldados de 100mm con radio sanitario.
- **Estante** base con doble omega de refuerzo.
- **Puertas batientes** 1 cara con bisagra vertical pivotante.
- **Patas** cilíndricas de acero inox 150mm regulables 50mm, 6 patas y **refuerzo** central a partir de 2000mm.

### Fondo 600

DIM (mm)	REF	PVP (€)
600	IDN54606 1P	<b>880</b>
800	IDN54608 2P	<b>1116</b>
1000	IDN54610 2P	<b>1202</b>
1200	IDN54612 2P	<b>1271</b>
1400	IDN54614 3P	<b>1351</b>
1500	IDN54615 3P	<b>1415</b>
1600	IDN54616 3P	<b>1489</b>
1800	IDN54618 4P	<b>1593</b>
2000	IDN54620 4P	<b>1685</b>
2200	IDN54622 4P	<b>1834</b>
2400	IDN54624 4P	<b>1926</b>

DIM (mm)	REF	PVP (€)
600	IDN64606 1P	<b>834</b>
800	IDN64608 2P	<b>1070</b>
1000	IDN64610 2P	<b>1156</b>
1200	IDN64612 2P	<b>1225</b>
1400	IDN64614 3P	<b>1305</b>
1500	IDN64615 3P	<b>1369</b>
1600	IDN64616 3P	<b>1443</b>
1800	IDN64618 4P	<b>1547</b>
2000	IDN64620 4P	<b>1639</b>
2200	IDN64622 4P	<b>1788</b>
2400	IDN64624 4P	<b>1880</b>

DIM (mm)	REF	PVP (€)
400	IDNM0446 1P	<b>523</b>
500	IDNM0546 1P	<b>552</b>
600	IDNM0646 1P	<b>598</b>
800	IDNM0846 2P	<b>805</b>
1000	IDNM1046 2P	<b>880</b>
1200	IDNM1246 2P	<b>926</b>

### Fondo 700

DIM (mm)	REF	PVP (€)
600	IDN54706 1P	<b>932</b>
800	IDN54708 2P	<b>1167</b>
1000	IDN54710 2P	<b>1254</b>
1200	IDN54712 2P	<b>1323</b>
1400	IDN54714 3P	<b>1409</b>
1500	IDN54715 3P	<b>1484</b>
1600	IDN54716 3P	<b>1547</b>
1800	IDN54718 4P	<b>1645</b>
2000	IDN54720 4P	<b>1742</b>
2200	IDN54722 4P	<b>1921</b>
2400	IDN54724 4P	<b>2001</b>

DIM (mm)	REF	PVP (€)
600	IDN64706 1P	<b>886</b>
800	IDN64708 2P	<b>1121</b>
1000	IDN64710 2P	<b>1208</b>
1200	IDN64712 2P	<b>1277</b>
1400	IDN64714 3P	<b>1363</b>
1500	IDN64715 3P	<b>1438</b>
1600	IDN64716 3P	<b>1501</b>
1800	IDN64718 4P	<b>1599</b>
2000	IDN64720 4P	<b>1696</b>
2200	IDN64722 4P	<b>1875</b>
2400	IDN64724 4P	<b>1955</b>

DIM (mm)	REF	PVP (€)
400	IDNM0447 1P	<b>546</b>
500	IDNM0547 1P	<b>575</b>
600	IDNM0647 1P	<b>615</b>
800	IDNM0847 2P	<b>840</b>
1000	IDNM1047 2P	<b>914</b>
1200	IDNM1247 2P	<b>955</b>

### MURAL BATIENTES



### CENTRAL BATIENTES



### MÓDULO BATIENTES



## MUEBLES/MÓDULOS NEUTROS PUERTAS BATIENTES CAJONES SUPERIORES H.850

- Encimeras **reforzadas** con omegas.
- **Frontal** soldado de 60mm en punto redondo, **peto** posterior soldado de 100mm con radio sanitario.
- **Estante** base con doble omega de refuerzo.
- **Cajones** con guías telescópicas.
- **Puertas batientes** 1 cara con bisagra vertical pivotante.
- **Patas** cilíndricas de acero inox 150mm regulables 50mm.

Medidas especiales en  
gama flexi estándar  
páginas 214 y 217.

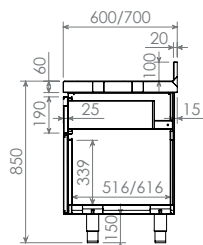

### Fondo 600

### Fondo 700

#### MURAL BATIENTES/CAJONES



DIM (mm)	REF	PVP (€)
400	IDN05604 1P/1C	1064
500	IDN05605 1P/1C	1121
600	IDN05606 1P/1C	1156
800	IDN05608 2P/2C	1374
1000	IDN05610 2P/2C	1420
1200	IDN05612 2P/2C	1512

DIM (mm)	REF	PVP (€)
400	IDN05704 1P/1C	1139
500	IDN05705 1P/1C	1196
600	IDN05706 1P/1C	1231
800	IDN05708 2P/2C	1449
1000	IDN05710 2P/2C	1495
1200	IDN05712 2P/2C	1587

#### CENTRAL BATIENTES/CAJONES



DIM (mm)	REF	PVP (€)
400	IDN15604 1P/1C	1018
500	IDN15605 1P/1C	1075
600	IDN15606 1P/1C	1110
800	IDN15608 2P/2C	1328
1000	IDN15610 2P/2C	1374
1200	IDN15612 2P/2C	1466

DIM (mm)	REF	PVP (€)
400	IDN15704 1P/1C	1093
500	IDN15705 1P/1C	1150
600	IDN15706 1P/1C	1185
800	IDN15708 2P/2C	1403
1000	IDN15710 2P/2C	1449
1200	IDN15712 2P/2C	1541

#### MÓDULO BATIENTES/CAJONES



DIM (mm)	REF	PVP (€)
400	IDNM5604 1P/1C	771
500	IDNM5605 1P/1C	805
600	IDNM5606 1P/1C	851
800	IDNM5608 2P/2C	1213
1000	IDNM5610 2P/2C	1248
1200	IDNM5612 2P/2C	1340

DIM (mm)	REF	PVP (€)
400	IDNM5704 1P/1C	794
500	IDNM5705 1P/1C	828
600	IDNM5706 1P/1C	874
800	IDNM5708 2P/2C	1311
1000	IDNM5710 2P/2C	1392
1200	IDNM5712 2P/2C	1438

Medidas especiales en gama flexi estándar páginas 214 y 217.

## MUEBLES/MÓDULOS NEUTROS PUERTAS BATIENTES SIN BASE H.850

- Encimeras **reforzadas** con omegas.
- **Frontal** soldado de 60mm en punto redondo, **peto** posterior soldado de 100mm con radio sanitario.
- **Base abierta.**
- **Puertas batientes** 1 cara con bisagra vertical pivotante.
- **Patas** cilíndricas de acero inox 150mm regulables 50mm.

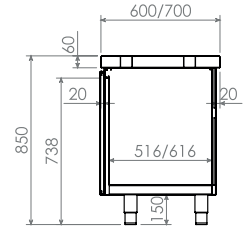

### Fondo 600

DIM (mm)	REF	PVP (€)
400	IDN08604 1P	<b>914</b>
500	IDN08605 1P	<b>943</b>
600	IDN08606 1P	<b>960</b>
800	IDN08608 2P	<b>1231</b>
1000	IDN08610 2P	<b>1317</b>
1200	IDN08612 2P	<b>1386</b>

### Fondo 700

DIM (mm)	REF	PVP (€)
400	IDN08704 1P	<b>1001</b>
500	IDN08705 1P	<b>1035</b>
600	IDN08706 1P	<b>1064</b>
800	IDN08708 2P	<b>1357</b>
1000	IDN08710 2P	<b>1438</b>
1200	IDN08712 2P	<b>1507</b>

### MURAL BATIENTES SIN BASE



DIM (mm)	REF	PVP (€)
400	IDN18604 1P	<b>868</b>
500	IDN18605 1P	<b>886</b>
600	IDN18606 1P	<b>920</b>
800	IDN18608 2P	<b>1185</b>
1000	IDN18610 2P	<b>1271</b>
1200	IDN18612 2P	<b>1340</b>

DIM (mm)	REF	PVP (€)
400	IDN18704 1P	<b>955</b>
500	IDN18705 1P	<b>995</b>
600	IDN18706 1P	<b>1035</b>
800	IDN18708 2P	<b>1294</b>
1000	IDN18710 2P	<b>1380</b>
1200	IDN18712 2P	<b>1438</b>

### CENTRAL BATIENTES SIN BASE



DIM (mm)	REF	PVP (€)
400	IDNM8604 1P	<b>535</b>
500	IDNM8605 1P	<b>575</b>
600	IDNM8606 1P	<b>621</b>
800	IDNM8608 2P	<b>828</b>
1000	IDNM8610 2P	<b>903</b>
1200	IDNM8612 2P	<b>949</b>

DIM (mm)	REF	PVP (€)
400	IDNM8704 1P	<b>569</b>
500	IDNM8705 1P	<b>598</b>
600	IDNM8706 1P	<b>638</b>
800	IDNM8708 2P	<b>863</b>
1000	IDNM8710 2P	<b>937</b>
1200	IDNM8712 2P	<b>978</b>

### MÓDULO BATIENTES SIN BASE





## MUEBLES NEUTROS CENTRALES RECICLAJE H.850

- Encimeras **reforzadas** con omegas.
- **Frontal** soldado de 60mm en punto redondo.
- **Base abierta.**
- **Puertas batientes** 1 cara con bisagra vertical pivotante para cada espacio cubo.
- **Aros** desbarace en caucho.
- **Patas** cilíndricas de acero inox 150mm regulables 50mm.

09.

NOVEDAD

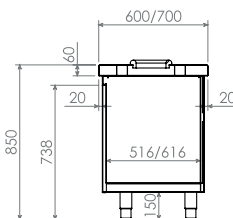

### ABIERTOS



### Fondo 600

LARGO (mm)	REF	PVP (€)	
400	1 aro	IDN30604	<b>621</b>
500	1 aro	IDN30605	<b>681</b>
600	1 aro	IDN30606	<b>798</b>
800	2 aros	IDN30608	<b>882</b>
1000	2 aros	IDN30610	<b>917</b>
1200	2 aros	IDN30612	<b>957</b>
1400	3 aros	IDN30614	<b>1059</b>
1500	3 aros	IDN30615	<b>1099</b>
1600	3 aros	IDN30616	<b>1139</b>
1800	4 aros	IDN30618	<b>1252</b>
2000	4 aros	IDN30620	<b>1367</b>
2200	4 aros	IDN30622	<b>1471</b>
2400	5 aros	IDN30624	<b>1624</b>

### Fondo 700

REF	PVP (€)
IDN30704	<b>636</b>
IDN30705	<b>699</b>
IDN30706	<b>815</b>
IDN30708	<b>899</b>
IDN30710	<b>940</b>
IDN30712	<b>997</b>
IDN30714	<b>1099</b>
IDN30715	<b>1133</b>
IDN30716	<b>1191</b>
IDN30718	<b>1304</b>
IDN30720	<b>1413</b>
IDN30722	<b>1517</b>
IDN30724	<b>1670</b>

### CERRADOS



LARGO (mm)	REF	PVP (€)	REF	PVP (€)
400	1 P. / 1 aro	IDN32604	IDN32704	<b>1081</b>
500	1 P. / 1 aro	IDN32605	IDN32705	<b>1121</b>
600	1 P. / 1 aro	IDN32606	IDN32706	<b>1162</b>
800	2 P. / 2 aros	IDN32608	IDN32708	<b>1420</b>
1000	2 P. / 2 aros	IDN32610	IDN32710	<b>1507</b>
1200	2 P. / 2 aros	IDN32612	IDN32712	<b>1564</b>
1400	3 P. / 3 aros	IDN32614	IDN32714	<b>1890</b>
1500	3 P. / 3 aros	IDN32615	IDN32715	<b>2000</b>
1600	3 P. / 3 aros	IDN32616	IDN32716	<b>2109</b>
1800	4 P. / 4 aros	IDN32618	IDN32718	<b>2415</b>
2000	4 P. / 4 aros	IDN32620	IDN32720	<b>2524</b>
2200	4 P. / 4 aros	IDN32622	IDN32722	<b>2634</b>
2400	5 P. / 5 aros	IDN32624	IDN32724	<b>2941</b>

### AROS Y TAPAS DESBARACE



DIM (mm)	REF	PVP (€)
Goma para aro desbarace 200Ø NEGRO	IDL45000	<b>24</b>
Goma para aro desbarace 200Ø AMARILLO	IDL45002	<b>24</b>
Goma para aro desbarace 200Ø VERDE	IDL45003	<b>24</b>
Goma para aro desbarace 200Ø AZUL	IDL45004	<b>24</b>
Goma para aro desbarace 200Ø ROJO	IDL45007	<b>24</b>
Tapa para aro desbarace 200Ø	IDL45001	<b>46</b>

# 09.

**NOVEDAD**

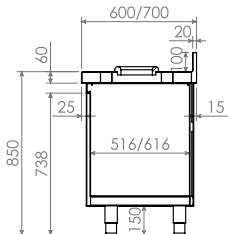

## MUEBLES NEUTROS MURALES RECICLAJE H.850

- Encimeras **reforzadas** con omegas.
- **Frontal** soldado de 60mm en punto redondo, **peto** posterior soldado de 100mm con radio sanitario.
- **Base abierta.**
- **Puertas batientes** 1 cara con bisagra vertical pivotante para cada espacio cubo.
- **Aros** desbarace en caucho negro.
- **Patas** cilíndricas de acero inox 150mm regulables 50mm.

### ABIERTOS

#### Fondo 600

LARGO (mm)	REF	PVP (€)	
400	1 aro	IDN31604	<b>685</b>
500	1 aro	IDN31605	<b>745</b>
600	1 aro	IDN31606	<b>861</b>
800	2 aros	IDN31608	<b>945</b>
1000	2 aros	IDN31610	<b>980</b>
1200	2 aros	IDN31612	<b>1020</b>
1400	3 aros	IDN31614	<b>1122</b>
1500	3 aros	IDN31615	<b>1162</b>
1600	3 aros	IDN31616	<b>1202</b>
1800	4 aros	IDN31618	<b>1316</b>
2000	4 aros	IDN31620	<b>1431</b>
2200	4 aros	IDN31622	<b>1534</b>
2400	5 aros	IDN31624	<b>1688</b>

#### Fondo 700

LARGO (mm)	REF	PVP (€)	
400	1 aro	IDN31704	<b>699</b>
500	1 aro	IDN31705	<b>763</b>
600	1 aro	IDN31706	<b>878</b>
800	2 aros	IDN31708	<b>963</b>
1000	2 aros	IDN31710	<b>1003</b>
1200	2 aros	IDN31712	<b>1060</b>
1400	3 aros	IDN31714	<b>1162</b>
1500	3 aros	IDN31715	<b>1197</b>
1600	3 aros	IDN31716	<b>1254</b>
1800	4 aros	IDN31718	<b>1367</b>
2000	4 aros	IDN31720	<b>1477</b>
2200	4 aros	IDN31722	<b>1580</b>
2400	5 aros	IDN31724	<b>1734</b>



### CERRADOS

LARGO (mm)	REF	PVP (€)	
400	1 P. / 1 aro	IDN33604	<b>1041</b>
500	1 P. / 1 aro	IDN33605	<b>1070</b>
600	1 P. / 1 aro	IDN33606	<b>1087</b>
800	2 P. / 2 aros	IDN33608	<b>1357</b>
1000	2 P. / 2 aros	IDN33610	<b>1443</b>
1200	2 P. / 2 aros	IDN33612	<b>1512</b>
1400	3 P. / 3 aros	IDN33614	<b>1824</b>
1500	3 P. / 3 aros	IDN33615	<b>1931</b>
1600	3 P. / 3 aros	IDN33616	<b>2038</b>
1800	4 P. / 4 aros	IDN33618	<b>2341</b>
2000	4 P. / 4 aros	IDN33620	<b>2448</b>
2200	4 P. / 4 aros	IDN33622	<b>2555</b>
2400	5 P. / 5 aros	IDN33624	<b>2860</b>

LARGO (mm)	REF	PVP (€)	
400	1 P. / 1 aro	IDN33704	<b>1127</b>
500	1 P. / 1 aro	IDN33705	<b>1167</b>
600	1 P. / 1 aro	IDN33706	<b>1213</b>
800	2 P. / 2 aros	IDN33708	<b>1484</b>
1000	2 P. / 2 aros	IDN33710	<b>1604</b>
1200	2 P. / 2 aros	IDN33712	<b>1633</b>
1400	3 P. / 3 aros	IDN33714	<b>1981</b>
1500	3 P. / 3 aros	IDN33715	<b>2098</b>
1600	3 P. / 3 aros	IDN33716	<b>2216</b>
1800	4 P. / 4 aros	IDN33718	<b>2529</b>
2000	4 P. / 4 aros	IDN33720	<b>2646</b>
2200	4 P. / 4 aros	IDN33722	<b>2764</b>
2400	5 P. / 5 aros	IDN33724	<b>3079</b>



## MUEBLES/MÓDULOS NEUTROS CAJONES

# 09.

- Encimeras **reforzadas** con omegas.
- **Frontal** soldado de 60mm en punto redondo, **peto** posterior soldado de 100mm con radio sanitario.
- **Estante** base con doble omega de refuerzo.
- **Cajones** con guías telescópicas.
- **Patas** cilíndricas de acero inox 150mm regulables 50mm.

Medidas especiales en  
gama flexi estándar  
páginas 215 y 218.

### 2 CAJONES

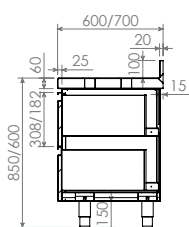

DIM (mm)	MURALES	PVP (€)
400x600x850	IDN04260	<b>874</b>
500x600x850	IDN05260	<b>926</b>
600x600x850	IDN06260	<b>1121</b>
400x600x600	IDN02460	<b>822</b>
500x600x600	IDN02560	<b>863</b>
600x600x600	IDN02660	<b>1052</b>
400x700x850	IDN04270	<b>909</b>
500x700x850	IDN05270	<b>960</b>
600x700x850	IDN06270	<b>1162</b>
400x700x600	IDN02470	<b>857</b>
500x700x600	IDN02570	<b>914</b>
600x700x600	IDN02670	<b>1081</b>

CENTRALES	PVP (€)
IDN14260	<b>811</b>
IDN15260	<b>863</b>
IDN16260	<b>1058</b>
IDN12460	<b>759</b>
IDN12560	<b>799</b>
IDN12660	<b>989</b>
IDN14270	<b>845</b>
IDN15270	<b>897</b>
IDN16270	<b>1098</b>
IDN12470	<b>794</b>
IDN12570	<b>851</b>
IDN12670	<b>1018</b>

MÓDULOS	PVP (€)
IDNM4260	<b>736</b>
IDNM5260	<b>776</b>
IDNM6260	<b>949</b>
IDNM2460	<b>684</b>
IDNM2560	<b>713</b>
IDNM2660	<b>880</b>
IDNM4270	<b>771</b>
IDNM5270	<b>811</b>
IDNM6270	<b>989</b>
IDNM2470	<b>719</b>
IDNM2570	<b>765</b>
IDNM2670	<b>909</b>

### Fondo 600

### Fondo 700

### 3 CAJONES

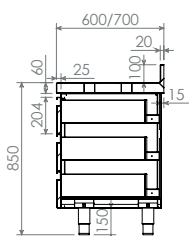

DIM (mm)	MURALES	PVP (€)
400x600x850	IDN04360	<b>897</b>
500x600x850	IDN05360	<b>960</b>
600x600x850	IDN06360	<b>1150</b>
400x700x850	IDN04370	<b>926</b>
500x700x850	IDN05370	<b>1001</b>
600x700x850	IDN06370	<b>1202</b>

CENTRALES	PVP (€)
IDN14360	<b>834</b>
IDN15360	<b>897</b>
IDN16360	<b>1087</b>
IDN14370	<b>863</b>
IDN15370	<b>937</b>
IDN16370	<b>1139</b>

MÓDULOS	PVP (€)
IDNM4360	<b>759</b>
IDNM5360	<b>811</b>
IDNM6360	<b>977</b>
IDNM4370	<b>788</b>
IDNM5370	<b>851</b>
IDNM6370	<b>995</b>

### Fondo 600

### Fondo 700

# 09.

Medidas especiales en  
gama flexi estándar  
páginas 215 y 218.

## 4 CAJONES

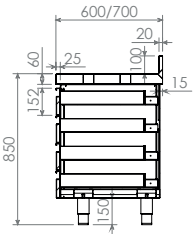

### Fondo 600

### Fondo 700

DIM (mm)	MURALES	PVP (€)
400x600x850	IDN04460	1012
500x600x850	IDN05460	1075
600x600x850	IDN06460	1265
400x700x850	IDN04470	1041
500x700x850	IDN05470	1116
600x700x850	IDN06470	1317

CENTRALES	PVP (€)
IDN14460	949
IDN15460	1012
IDN16460	1202
IDN14470	978
IDN15470	1052
IDN16470	1254

MÓDULOS	PVP (€)
IDNM4460	874
IDNM5460	926
IDNM6460	1093
IDNM4470	903
IDNM5470	966
IDNM6470	1144

## TOLVA

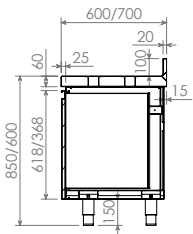

### Fondo 600

### Fondo 700

DIM (mm)	MURALES	PVP (€)
400x600x850	IDN04160	834
500x600x850	IDN05160	880
600x600x850	IDN06160	1070
400x600x600	IDN01460	782
500x600x600	IDN01560	828
600x600x600	IDN01660	995
400x700x850	IDN04170	868
500x700x850	IDN05170	920
600x700x850	IDN06170	1110
400x700x600	IDN01470	822
500x700x600	IDN01570	868
600x700x600	IDN01670	1052

CENTRALES	PVP (€)
IDN14160	771
IDN15160	817
IDN16160	1006
IDN11460	719
IDN11560	765
IDN11660	932
IDN14170	817
IDN15170	857
IDN16170	1047
IDN11470	759
IDN11570	805
IDN11670	989

MÓDULOS	PVP (€)
IDNM4160	696
IDNM5160	730
IDNM6160	897
IDNM1460	644
IDNM1560	679
IDNM1660	822
IDNM4170	730
IDNM5170	771
IDNM6170	937
IDNM1470	684
IDNM1570	719
IDNM1670	880

## MUEBLES/MÓDULOS NEUTROS CUERPO DE GUÍAS

- Encimeras **reforzadas** con omegas.
- **Frontal** soldado de 60mm en punto redondo, **peto** posterior soldado de 100mm con radio sanitario.
- **Estante** base con doble omega de refuerzo.
- Cuerpo de **guías** de chapa para cubetas GN/pasteleras (según modelo).
- **Patas** cilíndricas de acero inox 150mm regulable 50mm.

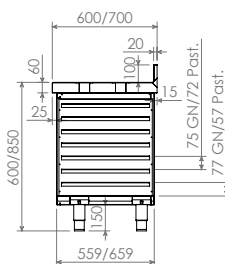

### MURAL GUÍAS



#### Guías GN 1/1

DIM (mm)		REF	PVP (€)
400x600x850	1 cuerpo	IDN06604	<b>748</b>
800x600x850	2 cuerpos	IDN06608	<b>1029</b>
400x700x850	1 cuerpo	IDN06704	<b>765</b>
800x700x850	2 cuerpos	IDN06708	<b>1041</b>

DIM (mm)		REF	PVP (€)
400x600x600	1 cuerpo	IDN00466	<b>730</b>
800x600x600	2 cuerpos	IDN00866	<b>1012</b>
400x700x600	1 cuerpo	IDN00467	<b>748</b>
800x700x600	2 cuerpos	IDN00867	<b>1024</b>

#### Bandejas pasteleras 600x400

DIM (mm)		REF	PVP (€)
700x600x850	1 cuerpo	IDN06607	<b>1006</b>
500x700x850	1 cuerpo	IDN06705	<b>811</b>
1000x700x850	2 cuerpos	IDN06710	<b>1075</b>

DIM (mm)		REF	PVP (€)
700x600x600	1 cuerpo	IDN00766	<b>989</b>
500x700x600	1 cuerpo	IDN00567	<b>782</b>
1000x700x600	2 cuerpos	IDN01067	<b>1058</b>

### CENTRAL GUÍAS



#### Guías GN 1/1

DIM (mm)		REF	PVP (€)
400x600x850	1 cuerpo	IDN16604	<b>684</b>
800x600x850	2 cuerpos	IDN16608	<b>966</b>
400x700x850	1 cuerpo	IDN16704	<b>702</b>
800x700x850	2 cuerpos	IDN16708	<b>978</b>

DIM (mm)		REF	PVP (€)
400x600x600	1 cuerpo	IDN10466	<b>667</b>
800x600x600	2 cuerpos	IDN10866	<b>949</b>
400x700x600	1 cuerpo	IDN10467	<b>684</b>
800x700x600	2 cuerpos	IDN10867	<b>960</b>

#### Bandejas pasteleras 600x400

DIM (mm)		REF	PVP (€)
700x600x850	1 cuerpo	IDN16607	<b>943</b>
500x700x850	1 cuerpo	IDN16705	<b>748</b>
1000x700x850	2 cuerpos	IDN16710	<b>1012</b>

DIM (mm)		REF	PVP (€)
700x600x600	1 cuerpo	IDN10766	<b>926</b>
500x700x600	1 cuerpo	IDN10567	<b>719</b>
1000x700x600	2 cuerpos	IDN11067	<b>995</b>

### MÓDULO GUÍAS



#### Guías GN 1/1

DIM (mm)		REF	PVP (€)
400x600x850	1 cuerpo	IDNM6604	<b>575</b>
800x600x850	2 cuerpos	IDNM6608	<b>811</b>
400x700x850	1 cuerpo	IDNM6704	<b>592</b>
800x700x850	2 cuerpos	IDNM6708	<b>828</b>

DIM (mm)		REF	PVP (€)
400x600x600	1 cuerpo	IDNM0466	<b>552</b>
800x600x600	2 cuerpos	IDNM0866	<b>788</b>
400x700x600	1 cuerpo	IDNM0467	<b>569</b>
800x700x600	2 cuerpos	IDNM0867	<b>788</b>

#### Bandejas pasteleras 600x400

DIM (mm)		REF	PVP (€)
700x600x850	1 cuerpo	IDNM6607	<b>799</b>
500x700x850	1 cuerpo	IDNM6705	<b>610</b>
1000x700x850	2 cuerpos	IDNM6710	<b>845</b>

DIM (mm)		REF	PVP (€)
700x600x600	1 cuerpo	IDNM0766	<b>782</b>
500x700x600	1 cuerpo	IDNM0567	<b>598</b>
1000x700x600	2 cuerpos	IDNM1067	<b>822</b>



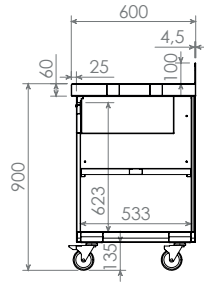

## MUEBLES APOYO TERRAZA

- Encimeras **reforzadas** con omegas.
- **Frontal** soldado de 60mm en punto redondo, **peto** posterior de 100mm visto a 2 caras.
- **Estante** base con doble omega de refuerzo, estante intermedio regulable reforzado con omega central.
- 1 **cajón** guías telescópicas.
- **Espacio** para basura con puerta batiente frontal pivotante y basculante superior.
- **Mochila** lateral para bandejas.
- **Trasera** acero inoxidable.
- 4 **ruedas** diámetro 125mm, 2 con freno, 4 parachoques de protección.



DIM (mm)	REF	PVP (€)
1200x600x900	IDN06125	1639
1500x600x900	IDN06155	1783



## PETO LATERAL POSTIZO MUEBLE TERRAZA

DIM (mm)	REF	PVP (€)
600X2X100	IDN00061	104

## MUEBLE CONTENEDOR DE RESIDUOS

- Estante base reforzado con doble omega de refuerzo.
- Puerta batiente frontal con abatible superior.

DIM (mm)	REF	PVP (€)
650x600x1200	IDN06065	1029

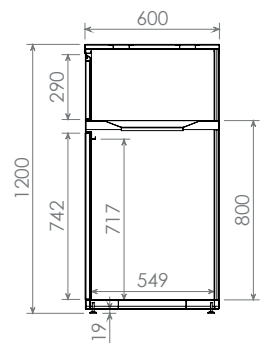

## GAMA AMPLIADA



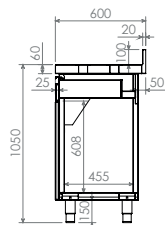

## MUEBLES CAFETEROS H.1050

- Encimeras **reforzadas** con omegas, con agujero pasacables  $\varnothing$ 52mm.
- **Frontal** soldado de 60mm en punto redondo, **peto** posterior soldado de 100mm con radio sanitario.
- **Estante** base con doble omega de refuerzo.
- **Trasera** abierta para facilitar conexiones.
- **Tolva** picamarro reforzada.
- **Cajones** con guías telescópicas
- **Puertas batientes** con bisagra pivotante.
- **Patas** cilíndricas de acero inox 150mm regulables 50mm.



Medidas especiales en  
gama flexi estándar  
página 219



	DIM (mm)	REF	PVP (€)
	400x600	IDK06004	<b>655</b>
	800x600	IDK06008	<b>874</b>
	1000x600	IDK06010	<b>1012</b>
	1500x600	IDK06015	<b>1311</b>

MUEBLES  
CONTRAMOSTRADOR H.1050

- **Frontal** soldado de 60mm en punto redondo, **peto** posterior soldado de 100mm con radio sanitario.
- **Estante** base con doble omega de refuerzo, estantes intermedios regulables reforzados con omega central.
- **Patas** cilíndricas de acero inox 150mm regulables 50mm.

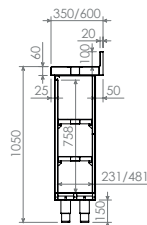

## 1 ESTANTE INTERMEDIO

## Fondo 350

DIM (mm)	REF	PVP (€)
800	IDK35008	<b>529</b>
1000	IDK35010	<b>581</b>
1200	IDK35012	<b>667</b>
1500	IDK35015	<b>753</b>
1800	IDK35018	<b>820</b>
2000	IDK35020	<b>886</b>

## Fondo 600

DIM (mm)	REF	PVP (€)
800	IDK60008	<b>690</b>
1000	IDK60010	<b>725</b>
1200	IDK60012	<b>794</b>
1500	IDK60015	<b>886</b>
1800	IDK60018	<b>964</b>
2000	IDK60020	<b>1041</b>



## 2 ESTANTES INTERMEDIOS

## Fondo 350

DIM (mm)	REF	PVP (€)
800	IDK35208	<b>581</b>
1000	IDK35210	<b>638</b>
1200	IDK35212	<b>730</b>
1500	IDK35215	<b>828</b>
1800	IDK35218	<b>900</b>
2000	IDK35220	<b>972</b>

## Fondo 600

DIM (mm)	REF	PVP (€)
800	IDK60208	<b>759</b>
1000	IDK60210	<b>799</b>
1200	IDK60212	<b>874</b>
1500	IDK60215	<b>972</b>
1800	IDK60218	<b>1058</b>
2000	IDK60220	<b>1144</b>



# 09.

Medidas especiales en gama flexi estándar página 210

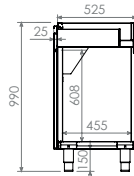

## GAMA AMPLIADA

### MÓDULOS CAFETEROS H.990

- **Estante** base con doble omega de refuerzo.
- **Trasera** abierta para facilitar conexiones
- Tolva **picamarro** reforzada.
- **Cajones** con guías telescópicas.
- **Puertas batientes** con bisagra pivotante.
- **Patas** cilíndricas de acero inox 150mm regulables 50mm.

	DIM (mm)	REF	PVP (€)
	400x600	IDKM0604	518
	800x600	IDKM0608	690
	1000x600	IDKM0610	811
	1500x600	IDKM0615	1001

### MÓDULOS CONTRAMOSTRADOR H.990

- **Estante** base con doble omega de refuerzo, estantes intermedios regulables reforzados con omega central.
- **Patas** cilíndricas de acero inox 150mm regulable 50mm.

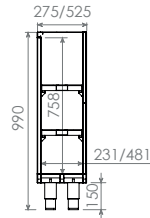

#### 1 ESTANTE INTERMEDIO

##### Fondo 350

DIM (mm)	REF	PVP (€)
800	IDKM3008	443
1000	IDKM3010	477
1200	IDKM3012	523
1500	IDKM3015	564
1800	IDKM3018	607
2000	IDKM3020	650

##### Fondo 600

DIM (mm)	REF	PVP (€)
800	IDKM6008	518
1000	IDKM6010	535
1200	IDKM6012	575
1500	IDKM6015	650
1800	IDKM6018	690
2000	IDKM6020	730



#### 2 ESTANTES INTERMEDIOS

##### Fondo 350

DIM (mm)	REF	PVP (€)
800	IDKM3208	495
1000	IDKM3210	529
1200	IDKM3212	587
1500	IDKM3215	638
1800	IDKM3218	687
2000	IDKM3220	736

##### Fondo 600

DIM (mm)	REF	PVP (€)
800	IDKM6208	587
1000	IDKM6210	615
1200	IDKM6212	684
1500	IDKM6215	753
1800	IDKM6218	831
2000	IDKM6220	909



## ENCIMERAS PARA MÓDULOS

- **Reforzadas** con omegas.
- **Frontal** soldado de 60mm con punto redondo, **peto** posterior soldado de 100mm con radio sanitario.

Medidas especiales en gama flexi estándar página 211.

Se suministran montadas a los módulos con compra conjunta.

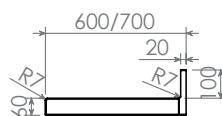
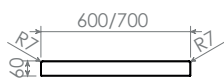

### CENTRALES

#### Fondo 600

DIM (mm)	REF	PVP (€)
400	IDE06104	259
500	IDE06105	265
600	IDE06106	270
700	IDE06107	276
800	IDE06108	282
900	IDE06109	288
1000	IDE06110	293
1100	IDE06111	311
1200	IDE06112	316
1300	IDE06113	328
1400	IDE06114	345
1500	IDE06115	374
1600	IDE06116	408
1700	IDE06117	431
1800	IDE06118	454
1900	IDE06119	466
2000	IDE06120	483
2100	IDE06121	500
2200	IDE06122	512
2300	IDE06123	529
2400	IDE06124	546
2500	IDE06125	575
2600	IDE06126	604
2700	IDE06127	633
2800	IDE06128	661
2900	IDE06129	690
3000	IDE06130	719

#### Fondo 700

DIM (mm)	REF	PVP (€)
400	IDE07104	311
500	IDE07105	316
600	IDE07106	322
700	IDE07107	328
800	IDE07108	334
900	IDE07109	339
1000	IDE07110	345
1100	IDE07111	362
1200	IDE07112	368
1300	IDE07113	385
1400	IDE07114	403
1500	IDE07115	431
1600	IDE07116	466
1700	IDE07117	489
1800	IDE07118	512
1900	IDE07119	529
2000	IDE07120	546
2100	IDE07121	564
2200	IDE07122	575
2300	IDE07123	592
2400	IDE07124	610
2500	IDE07125	638
2600	IDE07126	667
2700	IDE07127	696
2800	IDE07128	725
2900	IDE07129	753
3000	IDE07130	782

### MURALES

#### Fondo 600

DIM (mm)	REF	PVP (€)
400	IDE06004	282
500	IDE06005	288
600	IDE06006	293
700	IDE06007	299
800	IDE06008	305
900	IDE06009	311
1000	IDE06010	316
1100	IDE06011	334
1200	IDE06012	339
1300	IDE06013	351
1400	IDE06014	368
1500	IDE06015	397
1600	IDE06016	431
1700	IDE06017	454
1800	IDE06018	477
1900	IDE06019	489
2000	IDE06020	506
2100	IDE06021	523
2200	IDE06022	535
2300	IDE06023	552
2400	IDE06024	569
2500	IDE06025	598
2600	IDE06026	627
2700	IDE06027	656
2800	IDE06028	684
2900	IDE06029	713
3000	IDE06030	742

#### Fondo 700

DIM (mm)	REF	PVP (€)
400	IDE07004	334
500	IDE07005	339
600	IDE07006	345
700	IDE07007	351
800	IDE07008	357
900	IDE07009	362
1000	IDE07010	368
1100	IDE07011	385
1200	IDE07012	397
1300	IDE07013	414
1400	IDE07014	437
1500	IDE07015	454
1600	IDE07016	477
1700	IDE07017	506
1800	IDE07018	535
1900	IDE07019	552
2000	IDE07020	569
2100	IDE07021	587
2200	IDE07022	598
2300	IDE07023	615
2400	IDE07024	633
2500	IDE07025	661
2600	IDE07026	690
2700	IDE07027	719
2800	IDE07028	748
2900	IDE07029	776
3000	IDE07030	805

# 09.

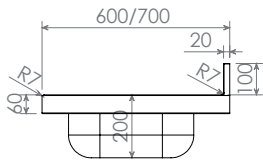

## ENCIMERAS MURALES CHEF PARA MÓDULOS

- **Reforzadas** con omegas.
- **Frontal** soldado de 60mm en punto redondo, **peto** posterior soldado de 100mm con radio sanitario.
- **Cuba** soldada 400x400x200mm.
- **Preparadas** para incorporarse a módulos estándar.



### CUBA DERECHA

DIM (mm)	REF	PVP (€)
1000x600x60	IDXE610D	443
1200x600x60	IDXE612D	472
1400x600x60	IDXE614D	518
1500x600x60	IDXE615D	564
1600x600x60	IDXE616D	615
1800x600x60	IDXE618D	667
2000x600x60	IDXE620D	719

### CUBA IZQUIERDA

REF	PVP (€)
IDXE610I	443
IDXE612I	472
IDXE614I	518
IDXE615I	564
IDXE616I	615
IDXE618I	667
IDXE620I	719

### CUBA CENTRAL

REF	PVP (€)
IDXE616C	627
IDXE618C	679
IDXE620C	730

DIM (mm)	REF	PVP (€)
1000x700x60	IDXE710D	489
1200x700x60	IDXE712D	523
1400x700x60	IDXE714D	569
1500x700x60	IDXE715D	610
1600x700x60	IDXE716D	661
1800x700x60	IDXE718D	713
2000x700x60	IDXE720D	771

REF	PVP (€)
IDXE710I	489
IDXE712I	523
IDXE714I	569
IDXE715I	610
IDXE716I	661
IDXE718I	713
IDXE720I	771

REF	PVP (€)
IDXE716C	684
IDXE718C	725
IDXE720C	794

DIM (mm)	REF	PVP (€)
500x500x60	IDE50050	368
500x600x60	IDE50060	385
500x700x60	IDE50070	408
600x500x60	IDE60050	385
600x600x60	IDE60060	414
600x700x60	IDE60070	431
700x500x60	IDE70050	408
700x600x60	IDE70060	431
700x700x60	IDE70070	472

## ENCIMERAS MURALES ANGULARES ESTÁNDAR

- **Reforzadas** con omegas.
- **Frontal** soldado de 60mm en punto redondo, **peto** posterior y lateral soldados de 100mm con radio sanitario.





## ARMARIOS DE PIE ABIERTOS

- **Estante** base con doble omega de refuerzo, 2 estantes intermedios regulables, estante central soldado, reforzados con omegas inox.
- **Patas** cilíndricas de acero inox 150mm regulables 50mm, 6 patas y **refuerzo** central a partir de 1400mm.

DIM (mm)	REF	PVP (€)
600x600x1900	IDA21006	<b>955</b>
1000x600x1900	IDA21010	<b>1052</b>
1200x600x1900	IDA21012	<b>1162</b>
1400x600x1900	IDA21014	<b>1271</b>
1500x600x1900	IDA21015	<b>1380</b>
1600x600x1900	IDA21016	<b>1489</b>

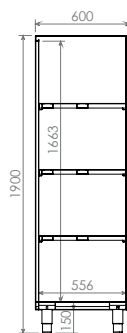

Medidas especiales en gama flexi estándar página 220.



## ARMARIOS DE PIE PUERTAS BATIENTES

- **Estante** base con doble omega de refuerzo, 2 estantes intermedios regulables, estante central soldado, reforzados con omegas inox.
- **Puertas batientes** con bisagra vertical pivotante.
- **Patas** cilíndricas de acero inox 150mm regulables 50mm, 6 patas y **refuerzo** central a partir de 1400mm.

DIM (mm)	REF	PVP (€)
600x600x1900	IDA22006 1P	<b>1208</b>
1000x600x1900	IDA22010 2P	<b>1685</b>
1200x600x1900	IDA22012 2P	<b>2013</b>
1400x600x1900	IDA22014 2P	<b>2087</b>
1500x600x1900	IDA22015 2P	<b>2202</b>
1600x600x1900	IDA22016 2P	<b>2340</b>

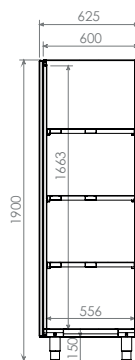

## ARMARIOS DE PIE PUERTAS CORREDERAS

- **Estante** base con doble omega de refuerzo, 2 estantes intermedios regulables, estante central soldado, reforzados con omegas inox.
- **Puertas correderas** con rodamiento superior de nylon.
- **Patas** cilíndricas de acero inox 150mm regulables 50mm, 6 patas y **refuerzo** central a partir de 1400mm.

DIM (mm)	REF	PVP (€)
1000x600x1900	IDA22110	<b>1852</b>
1200x600x1900	IDA22112	<b>1978</b>
1400x600x1900	IDA22114	<b>2139</b>
1500x600x1900	IDA22115	<b>2237</b>
1600x600x1900	IDA22116	<b>2306</b>
1800x600x1900	IDA22118	<b>2829</b>
2000x600x1900	IDA22120	<b>3048</b>

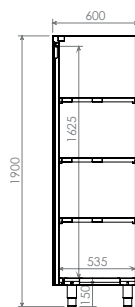

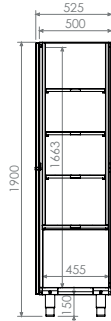

## ARMARIOS DE PIE PRODUCTOS DE LIMPIEZA

- **Estante** base con doble omega de refuerzo, 4 estantes intermedios soldados y reforzados con omegas inoxidables.
- **Puertas batientes** con bisagra vertical pivotante.
- **Cerradura** con llave incluida.
- **Patas** cilíndricas acero inox regulables 50mm.

DIM (mm)	REF		PVP (€)
600x500x1900	IDA22306	1P	1196
1000x500x1900	IDA22310	2P	1553

### NOVEDAD

## ARMARIOS DE PIE RECICLAJE

- **Estante** base con doble omega de refuerzo
- **Aros** de desbarace de caucho.
- **Puerta batiente** con bisagra vertical pivotante.
- **Recipiente** plástico interior incluido.
- **Patas** cilíndricas acero inox regulables 50mm.

DIM (mm)	REF	PVP (€)
400x500x1200	2 aros IDA22312	863
400x500x1600	3 aros IDA22316	1012
400x500x2000	4 aros IDA22320	1162

### NOVEDAD

## VISERA SUPERIOR PARA ARMARIOS NEUTROS

- **Preparados** para montarse en parte superior de armarios.

DIM (mm)	REF	PVP (€)
400x500x200	IDA23004	130
600x500x200	IDA23006	136
1000x500x200	IDA23010	159
600x600x200	IDA23006	155
1000x600x200	IDA23010	179
1200x600x200	IDA23012	189
1400x600x200	IDA23014	199
1500x600x200	IDA23015	209
1600x600x200	IDA23016	221
1800x600x200	IDA23018	233
2000x600x200	IDA23020	247

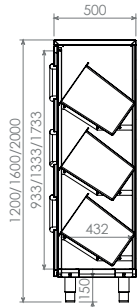

**Montaje rápido y fácil**  
mediante tornillería.

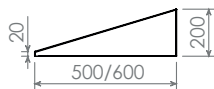

## ARMARIOS COLGANTES FRONTAL ABIERTO

- **Estante** base reforzado con doble omega de refuerzo, 1 estante intermedio regulable y reforzado con omega inox.

DIM (mm)	REF	PVP (€)
800x400x600	IDA22708	529
1000x400x600	IDA22710	581
1200x400x600	IDA22712	633
1400x400x600	IDA22714	684
1500x400x600	IDA22715	736
1600x400x600	IDA22716	788
1800x400x600	IDA22718	840

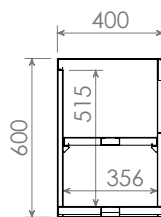

Medidas especiales en  
gama flexi estándar  
página 221.



## ARMARIOS COLGANTES PUERTAS CORREDERAS

- **Estante** base con doble omega de refuerzo, 1 estante intermedio regulable y reforzado con omega inox.
- **Puertas correderas** con rodamiento superior de nylon.
- **Refuerzo** central a partir de 1400mm.

DIM (mm)	REF	PVP (€)
800x400x600	IDA22208	748
1000x400x600	IDA22210	805
1200x400x600	IDA22212	845
1400x400x600	IDA22214	989
1500x400x600	IDA22215	1024
1600x400x600	IDA22216	1052
1800x400x600	IDA22218	1179

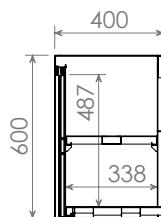

### Escurreidor inferior

- Base con **escurreidor** de varilla desmontable.

DIM (mm)	REF	PVP (€)
1000x400x600	IDA22510	857
1200x400x600	IDA22512	909
1400x400x600	IDA22514	995



## ARMARIOS COLGANTES PUERTAS BATIENTES

- **Estante** base reforzado con doble omega de refuerzo, 1 estante intermedio regulable y reforzado con omega inox.
- **Puertas batientes** con bisagra vertical pivotante.



DIM (mm)		REF	PVP (€)
400x400x600	1P	IDA22804	598
500x400x600	1P	IDA22805	638
600x400x600	1P	IDA22806	673
800x400x600	2P	IDA22808	840
1000x400x600	2P	IDA22810	886

## ARMARIOS COLGANTES ANGULARES

- **Estante** base con doble omega de refuerzo, 1 estante intermedio regulable y reforzado con omega inox.
- **Puerta batiente** con bisagra pivotante.

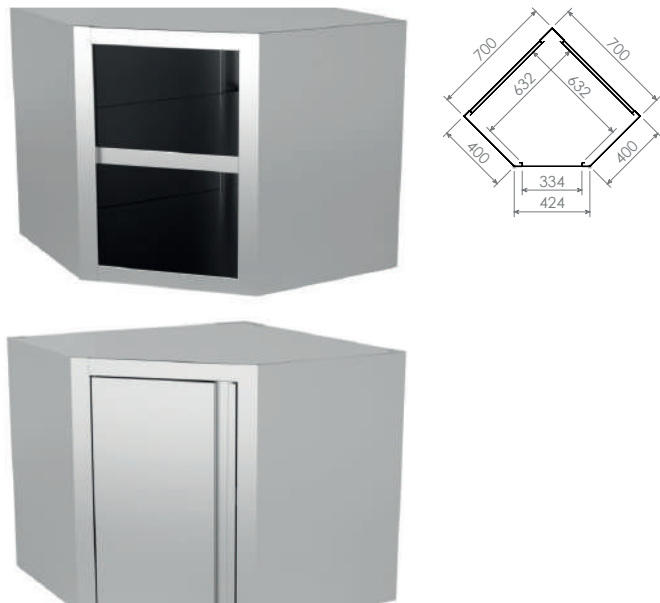

DIM (mm)		REF	PVP (€)
700x400x600	frontal abierto	IDA22807	857
700x400x600	puerta batiente	IDA22907	1041

### NOVEDAD

## VISERA SUPERIOR PARA ARMARIOS COLGANTES

- **Preparadas** para montarse en parte superior de armarios.



**Montaje rápido y fácil**  
mediante tornillería.

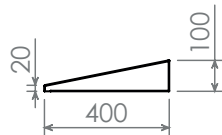

DIM (mm)		REF	PVP (€)
400x400x100		IDA23104	119
500x400x100		IDA23105	124
600x400x100		IDA23106	143
800x400x100		IDA23108	165
1000x400x100		IDA23110	174
1200x400x100		IDA23120	183
1400x400x100		IDA23140	193
1500x400x100		IDA23150	203
1600x400x100		IDA23160	215
1800x400x100		IDA23180	227

## MARCOS CON PUERTA PARA HUECOS DE MÓDULOS

- Marco perimetral de chapa
- Puerta **batiente** con bisagra vertical pivotante.

Montaje rápido y fácil  
mediante tornillería.



	DIM (mm)	REF	PVP (€)
h 600	400x80x390	IDNM4060	265
	500x80x390	IDNM5060	288
	600x80x390	IDNM6060	316
h 850	400x80x640	IDNM4085	288
	500x80x640	IDNM5085	311
	600x80x640	IDNM6085	339
h 1050	400x80x840	IDNM4105	368
	500x80x840	IDNM5105	408
	600x80x840	IDNM6105	449



## PETO LATERAL POSTIZO

- Preparados para montaje mediante tornillería.

Montaje rápido y fácil  
mediante tornillería.



DIM (mm)		REF	PVP (€)
580x20x100	mueble fondo 600	IDH9060D	127
580x20x100	mueble fondo 600	IDH9060I	127
680x20x100	mueble fondo 700	IDH9070D	132
680x20x100	mueble fondo 700	IDH9070I	132

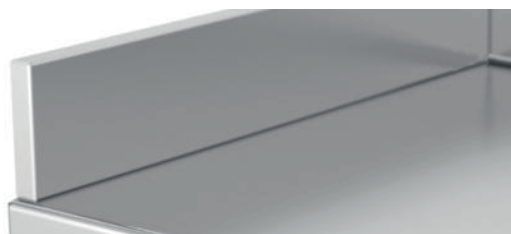

## CAJONES INDIVIDUALES PARA MUEBLES O MÓDULOS

- Cajones con guías telescópicas.

Montaje rápido y fácil  
mediante tornillería.



DIM (mm)	REF	PVP (€)
400x450x220	IDH04540	242
500x450x220	IDH04550	259







## ADAPTACIÓN CERRADURA

- **Adaptadas** a las puertas y cajones de la gama estándar.

REF	PVP (€)
IDH04580	86



## ZÓCALO PARA MUEBLES, MÓDULOS Y ARMARIOS

- **Preparado** para montarse sin herramientas en la parte inferior del mueble.

\* Precio por metro lineal.

DIM (mm)	REF	PVP (€)
Zócalo inferior	EID90400	81

## ADAPTACIÓN DE RUEDAS

- **Se suministran totalmente montadas** en la base de los módulos, muebles o armarios.

- Posición **ruedas** con freno o sin freno a elección del cliente, izquierda, derecha o frente.



### RUEDAS SINTÉTICAS

CARACTERÍSTICAS	REF	PVP (€)
4 Ruedas 125ø (2 con freno)	IDH90415	276
6 Ruedas 125ø (3 con freno)	IDH90425	374



### RUEDAS ACERO INOXIDABLE

CARACTERÍSTICAS	REF	PVP (€)
4 Ruedas 125ø (2 con freno)	IDH90435	328
6 Ruedas 125ø (3 con freno)	IDH90445	420

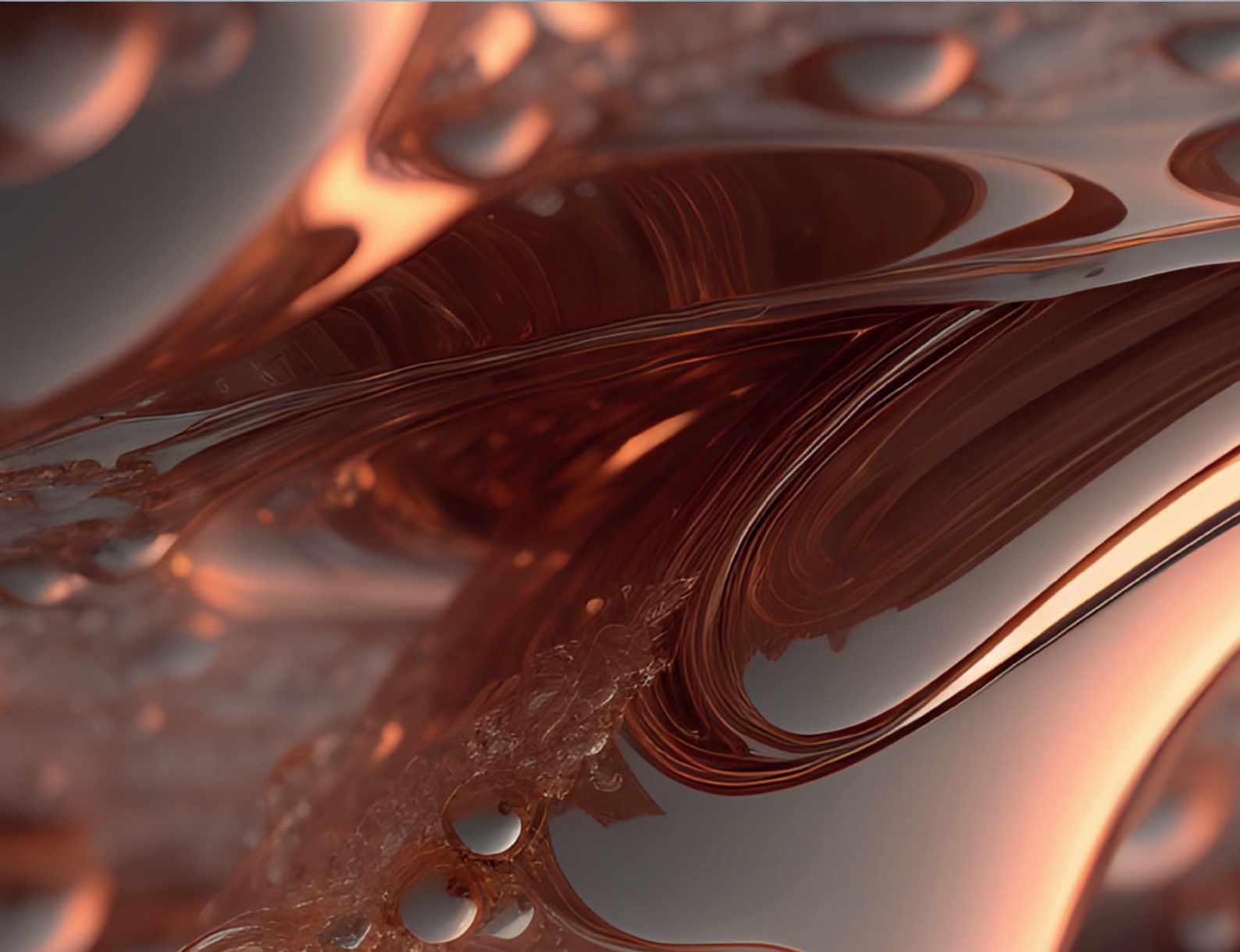

# 10.

- Mesas cocteleras y mochilas
- Muebles cocteleros y mochilas
- Muebles reserva fría y mochilas
- Kits decorativos
- Muebles soporte botellas
- Canales
- Accesorios

## MESAS MURALES COCTELERAS

- Encimera y estante inferior **reforzados** con omegas.
- **Frontal** de 60mm soldado en punto redondo, **peto** posterior soldado de 100mm con radio sanitario.
- **Cuba hielo** aislada, con separadores, fondo perforado y soporte para cubetas GN.
- **Cubeta** 270x360x150mm con mojacopas y polietileno de corte.
- **Aro** de desbarace en chapa.
- Cubeta GN 1/9 h.100 para utensilios **incluida**.
- **Patás** de tubo 40x40mm con taco regulable de 60mm.

Para medidas o composiciones especiales, consultar.

Accesorios y complementos páginas 146-147  
Grifería consultar páginas 50-51

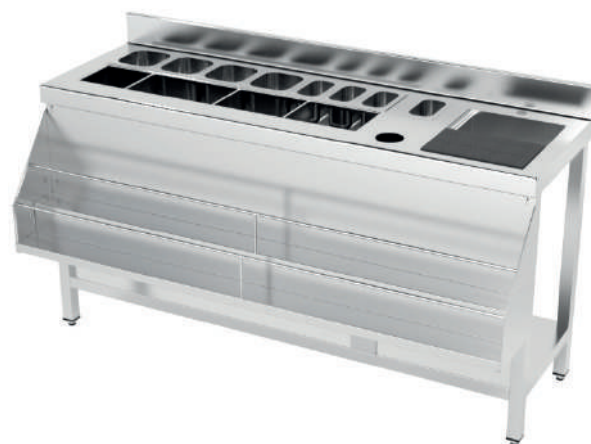

Ejemplo de composición. Cubetas GN 6/1 y mochilas no incluidas.

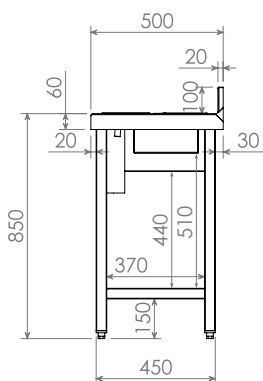

NUEVO MODELO

### MESAS MURALES COCTELERAS 1 CUBA

DIM (mm)	CUBA HIELO (mm)	CAPACIDAD GN	CUBA DCHA.	PVP (€)	CUBA IZQ.	PVP (€)
1200x500x850	630x340	4GN1/6 - 6GN1/9	IDM89012D	1570	IDM89012I	1570
1600x500x850	950x340	6GN1/6 - 9GN1/9	IDM89016D	1949	IDM89016I	1949



NOVEDAD

### MESA MURAL COCTELERA 2 CUBAS

DIM (mm)	CUBA HIELO (mm)	CAPACIDAD GN	CUBA DOS LADOS	PVP (€)
2000x500x850	950x340	6GN1/6 - 9GN1/9	IDM89020	2289







Ejemplo de composición.  
Cubetas GN no incluidas.

**NOVEDAD**

## MESAS MURALES COCTELERAS CUBA HIELO

DIM (mm)	CAPACIDAD GN	REF	PVP (€)
500x500x850	2GN1/6 - 3GN1/9	IDM89005	<b>1016</b>
800x500x850	4GN1/6 - 6GN1/9	IDM89008	<b>1047</b>
1000x500x850	5GN1/6 - 7GN1/9	IDM89010	<b>1113</b>

## MOCHILAS PARA MESA

- Preparadas para **fijación** a mesa coctelera mediante tornillería.



Montaje rápido y fácil  
mediante tornillería.

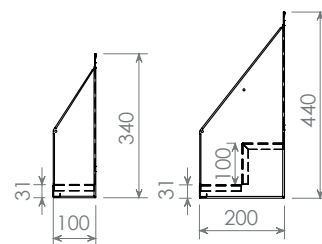

DIM (mm)	SIMPLE ANCHO 100	PVP (€)	DIM (mm)	DOBLE ANCHO 200	PVP (€)
500x340	IDH86105	<b>208</b>	500x440	IDH96150	<b>242</b>
700x340	IDH86107	<b>213</b>	700x440	IDH96107	<b>253</b>
800x340	IDH86108	<b>219</b>	800x440	IDH96108	<b>274</b>
1000x340	IDH86110	<b>225</b>	1000x440	IDH96110	<b>295</b>
1100x340	IDH86111	<b>237</b>	1100x440	IDH96111	<b>311</b>
1200x340	IDH86112	<b>247</b>	1200x440	IDH96112	<b>328</b>
1500x340	IDH86115	<b>288</b>	1500x440	IDH96115	<b>380</b>
1600x340	IDH86116	<b>305</b>	1600x440	IDH96116	<b>397</b>
2000x340	IDH86120	<b>351</b>	2000x440	IDH96120	<b>466</b>

## MOCHILA BATIDORAS

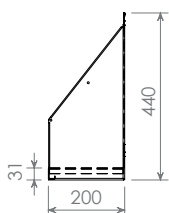

BATIDORAS	REF	PVP (€)
500x200x440	IDH96105	<b>219</b>



## MUEBLES MURALES COCTELEROS

- Encimera y estante base **reforzados** con omegas.
- **Frontal** de 60mm soldado en punto redondo, **peto** posterior soldado de 100mm con radio sanitario.
- **Cuba hielo** aislada, con separadores, fondo perforado y soporte para cubetas GN.
- **Cubeta** 270x450x150mm con mojacopas y polietileno de corte.
- **Aro** de desbarace en chapa.
- Cubeta GN 1/9 h.100 para utensilios **incluida**.
- **Patas** cilíndricas inoxidable 150mm regulables 60mm.

Para medidas o composiciones especiales, consultar.

Accesorios y complementos páginas 146-147  
Grifería consultar páginas 50-51

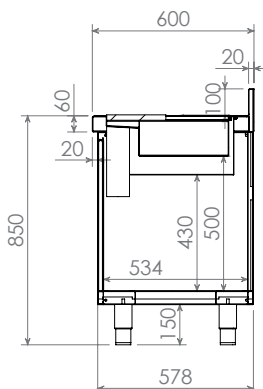

Ejemplo de composición.  
Cubetas GN 6/1 y mochilas no incluidas.



NUEVO MODELO

### MUEBLES MURALES COCTELEROS 1 CUBA

DIM (mm)	CUBA HIELO (mm)	CAPACIDAD GN	CUBA DCHA.	PVP (€)	CUBA IZQ.	PVP (€)
1200x600x850	630x410	4GN1/6 - 6GN1/9	IDN06112D	1955	IDN06112I	1955
1600x600x850	950x410	6GN1/6 - 9GN1/9	IDN06116D	2317	IDN06116I	2317

NOVEDAD

### MUEBLE MURAL COCTELERO 2 CUBAS

DIM (mm)	CUBA HIELO (mm)	CAPACIDAD GN	CUBA DOS LADOS	PVP (€)
2000x600x850	950x410	6GN1/6 - 9GN1/9	IDN06120	2743





Ejemplo de composición.  
Cubetas GN no incluidas.

**NOVEDAD**

## MUEBLES MURALES COCTELEROS CUBA HIELO

DIM (mm)	CAPACIDAD GN	REF	PVP (€)
500x600x850	2GN1/6 - 3GN1/9	IDN06105	<b>1155</b>
800x600x850	4GN1/6 - 6GN1/9	IDN06108	<b>1190</b>
1000x600x850	5GN1/6 - 7GN1/9	IDN06110	<b>1265</b>

## MOCHILAS PARA MUEBLE

- Preparadas para **fijación** a mesa coctelera mediante tornillería.



Montaje rápido y fácil mediante tornillería.

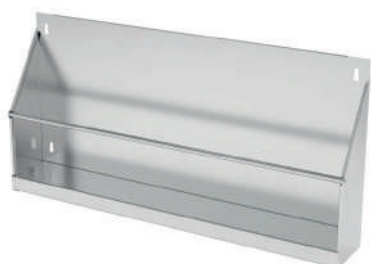
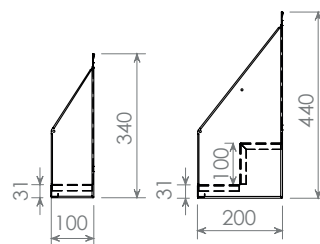

DIM (mm)	SIMPLE ANCHO 100	PVP (€)	DIM (mm)	DOBLE ANCHO 200	PVP (€)
500x340	IDH86105	<b>208</b>	500x440	IDH96150	<b>242</b>
700x340	IDH86107	<b>213</b>	700x440	IDH96107	<b>253</b>
800x340	IDH86108	<b>219</b>	800x440	IDH96108	<b>274</b>
1000x340	IDH86110	<b>225</b>	1000x440	IDH96110	<b>295</b>
1100x340	IDH86111	<b>237</b>	1100x440	IDH96111	<b>311</b>
1200x340	IDH86112	<b>247</b>	1200x440	IDH96112	<b>328</b>
1500x340	IDH86115	<b>288</b>	1500x440	IDH96115	<b>380</b>
1600x340	IDH86116	<b>305</b>	1600x440	IDH96116	<b>397</b>
2000x340	IDH86120	<b>351</b>	2000x440	IDH96120	<b>466</b>

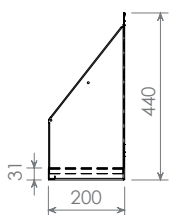

## MOCHILA BATIDORAS

BATIDORAS	REF	PVP (€)
500x200x440	IDH96105	<b>219</b>

## MUEBLES MURALES COCTELEROS RESERVA FRÍA

- Encimera y estante base **reforzados** con omegas.
- **Frontal** de 60mm soldado en punto redondo, **peto** posterior soldado de 100mm con radio sanitario.
- **Cuba hielo** aislada, con separadores, fondo perforado y soporte para cubetas GN.
- **Cubeta** 270x450x150mm con mojacopas y polietileno de corte.
- Cubeta GN 1/9 h.100 para utensilios **incluida**.
- **Reserva** inferior refrigerada con **cajones** aislados y guías telescópicas.
- **Termostato** digital.
- **Patas** regulable inferior 30mm.

Accesorios y complementos páginas 146-147  
Grifería consultar páginas 50-51



Ejemplo de composición.  
Cubetas y mochilas no incluidas.

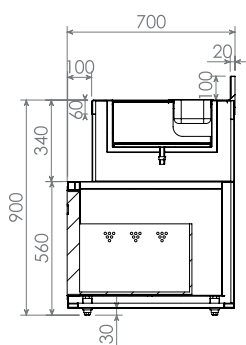

### NUEVO MODELO

## MUEBLES COCTELEROS REFRIGERADOS

DIM (mm)	CONSUMO/ TENSIÓN	CUBA HIELO (mm)	CAPACIDAD GN	CUBA DCHA.	PVP CUBA (€) IZQ.	PVP (€)
1200x700x900 - 1 cajón	235w 230v/50-60hz	630x410	4GN1/6 - 6GN1/9	IDNF6112D	<b>3134</b> IDNF6112I	<b>3134</b>
1600x700x900 - 2 cajones	235w 230v/50-60hz	950x410	6GN1/6 - 9GN1/9	IDNF6116D	<b>4399</b> IDNF6116I	<b>4399</b>



### NOVEDAD

## MUEBLE COCTELERO REFRIGERADO 2 CUBAS

DIM (mm)	CONSUMO / TENSIÓN	CUBA HIELO (mm)	CAPACIDAD GN	CUBA DOS LADOS	PVP (€)
2000x700x900 - 3 cajones	327w 230v/50-60hz	950x410	6GN1/6 - 9GN1/9	IDNF6120	<b>5146</b>



## MOCHILAS SIMPLES/DOBLES PARA MUEBLES CON RESERVA

- Preparadas para **fijación** a mueble coctelero mediante tornillería.



**Montaje rápido y fácil**  
mediante tornillería.

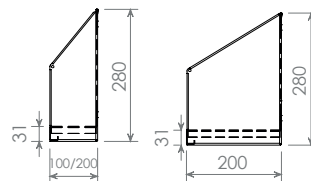

DIM (mm)	SIMPLE ANCHO 100	PVP (€)	DOBLE ANCHO 200	PVP (€)
700x100x280	IDH86207	<b>202</b>	IDH96207	<b>240</b>
1000x100x280	IDH86210	<b>214</b>	IDH96210	<b>280</b>
1100x100x280	IDH86211	<b>225</b>	IDH96211	<b>295</b>
1200x100x280	IDH86212	<b>234</b>	IDH96212	<b>312</b>
1500x100x280	IDH86215	<b>274</b>	IDH96215	<b>361</b>
1600x100x280	IDH86216	<b>290</b>	IDH96216	<b>377</b>
2000x100x280	IDH86220	<b>334</b>	IDH96220	<b>423</b>

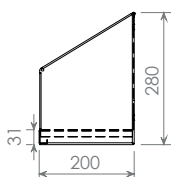

## MOCHILA BATIDORAS

BATIDORAS	REF	PVP (€)
500x200x280	IDH96205	<b>208</b>



## KITS DECORATIVOS PARA MUEBLES COCTELEROS

- Válidos para modelos con o sin reserva.
- Encimera superior con **canal** perforado y **desagüe** para el servicio de bebidas.
- **Panelado** frontal y laterales de acero plastificado, acero inoxidable o madera compact (material y colores a elegir).
- Adaptación de 4 **ruedas** giratorias  $\varnothing 100$ mm, 2 con freno.

DIM (mm)	REF	PVP (€)
Mueble 1200	IDN06912	<b>1098</b>
Mueble 1600	IDN06916	<b>1156</b>
Mueble 2000	IDN06920	<b>1254</b>

## MUEBLES SOPORTE BOTELLAS

- Encimera superior acero inox, 4 niveles para almacenaje y exposición de botellas, 1 estante inferior.
- **Patas** cilíndricas de acero inox 150mm regulables 50mm.

DIM (mm)	FONDO 500	PVP (€)	FONDO 600	PVP (€)
400x500x850	IDN45140	<b>909</b>	IDN46140	<b>972</b>
500x500x850	IDN45150	<b>966</b>	IDN46150	<b>1029</b>
600x500x850	IDN45160	<b>1064</b>	IDN46160	<b>1127</b>
800x500x850	IDN45180	<b>1098</b>	IDN46180	<b>1162</b>

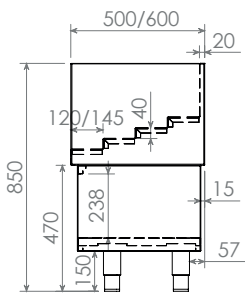

## CANALES DESAGÜE SOBREMESA

DIM (mm)	REF	PVP (€)
1200x210x400	IDH96512	<b>449</b>
1600x210x400	IDH96516	<b>483</b>
2000x210x400	IDH96520	<b>535</b>

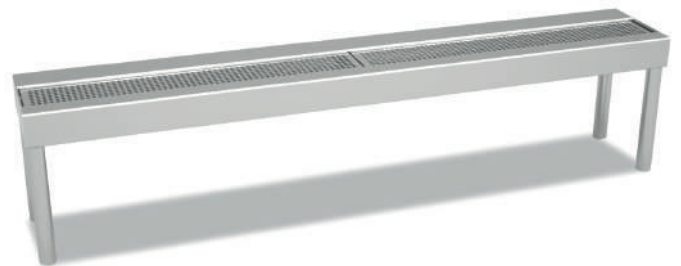
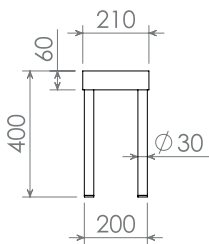

## BANDEJA PERFORADA PARA CUBA COCTELERA

DIM (mm)	REF	PVP (€)
295x180x20	IDH96202	<b>56</b>





## CANALES DESAGÜE SOBREBARRA



DIM (mm)	REF	PVP (€)
1200x180x20	IDH96412	167
1600x180x20	IDH96416	190
2000x180x20	IDH96420	219

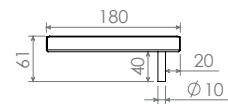

## POLIETILENO CORTE PARA CUBA COCTELERA



DIM (mm)	REF	PVP (€)
295x180x20	IDH96200	46

## POLIETILENOS FRONTALES GOLPEO

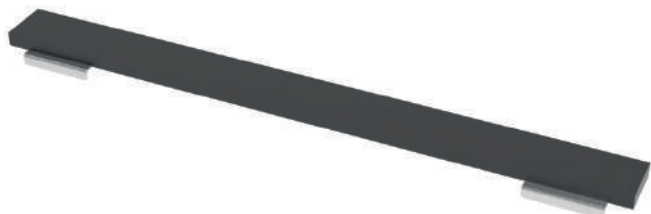

DIM (mm)	REF	PVP (€)
630x70x20 Cocteleras 1200	IDH96312	86
950x70x20 Cocteleras 1600/2000	IDH96316	104

## MOJACOPAS DE RECAMBIO PARA CUBETA COCTELERA



DIM (mm)	REF	PVP (€)
Ø100x20	IDH96201	46

## CUBETAS GN



### GN 1/9



### GN 1/6

DIM (mm)	LITROS	REF	PVP (€)
176x162x65	1	IDGN16065	14
176x162x100	1,6	IDGN16100	16

DIM (mm)	LITROS	REF	PVP (€)
176x108x65	0,6	IDGN19065	10
176x108x100	0,8	IDGN19100	15





# 11.

- Muebles/módulos calientes y accesorios
- Módulos calentaplatos
- Carros isotérmicos
- Carros calientes y accesorios
- Baños maría
- Carros cuba fría
- Carros fríos

## MUEBLES/MÓDULOS CALIENTES PUERTAS CORREDERAS

- Encimera **reforzada** con omegas.
- **Frontal** soldado de 60mm en punto redondo, peto posterior de 100mm con radio sanitario.
- **Aislados** con lana de roca.
- **Bloque calórico** lateral con resistencias ventiladas. Interruptor ON/OFF luminoso y termostato digital 0°C / 90°C.
- **Puertas correderas** aisladas, rodamientos superiores de nylon.
- **Estante** base con doble omega de refuerzo, estante intermedio regulable perforado.
- **Patas** cilíndricas de acero inox 150mm regulables 50mm.

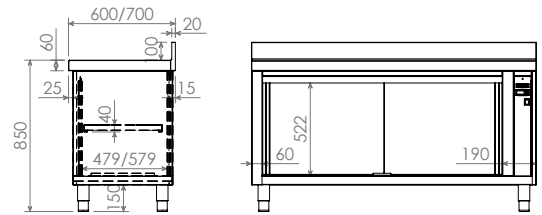

CENTRALES

MURALES

MÓDULOS

Fondo 600

Fondo 700

DIM (mm)	CONSUMO/ TENSIÓN	REF	PVP(€)	REF	PVP(€)	REF	PVP(€)
1200x600x850	2030w 230v/50-60Hz	IDNC1612	<b>2024</b>	IDNC3612	<b>2105</b>	IDMC1612	<b>1823</b>
1400x600x850	2030w 230v/50-60Hz	IDNC1614	<b>2225</b>	IDNC3614	<b>2340</b>	IDMC1614	<b>2001</b>
1600x600x850	2030w 230v/50-60Hz	IDNC1616	<b>2421</b>	IDNC3616	<b>2501</b>	IDMC1616	<b>2179</b>
1800x600x850	3030w 230v/50-60Hz	IDNC1618	<b>2685</b>	IDNC3618	<b>2783</b>	IDMC1618	<b>2415</b>
2000x600x850	3030w 230v/50-60Hz	IDNC1620	<b>2984</b>	IDNC3620	<b>3088</b>	IDMC1620	<b>2685</b>
1200x700x850	2030w 230v/50-60Hz	IDNC1712	<b>2076</b>	IDNC3712	<b>2156</b>	IDMC1712	<b>1869</b>
1400x700x850	2030w 230v/50-60Hz	IDNC1714	<b>2283</b>	IDNC3714	<b>2398</b>	IDMC1714	<b>2053</b>
1600x700x850	2030w 230v/50-60Hz	IDNC1716	<b>2484</b>	IDNC3716	<b>2565</b>	IDMC1716	<b>2248</b>
1800x700x850	3030w 230v/50-60Hz	IDNC1718	<b>2754</b>	IDNC3718	<b>2852</b>	IDMC1718	<b>2478</b>
2000x700x850	3030w 230v/50-60Hz	IDNC1720	<b>3059</b>	IDNC3720	<b>3168</b>	IDMC1720	<b>2754</b>

# 11.

## MUEBLES/MÓDULOS CALIENTES PUERTAS CORREDERAS PASANTES

- Encimera **reforzada** con omegas.
- **Frontal** soldado de 60mm en punto redondo, peto posterior de 100mm con radio sanitario.
- **Aislados** con lana de roca.
- **Bloque calórico** lateral con resistencias ventiladas. Interruptor ON/OFF luminoso y termostato digital 0°C / 90°C.
- **Puertas correderas** aisladas, rodamientos superiores de nylon.
- **Estante** base con doble omega de refuerzo, estante intermedio regulable perforado.
- **Patas** cilíndricas de acero inox 150mm regulables 50mm.

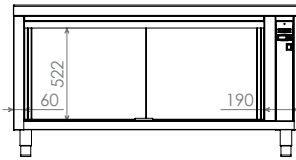
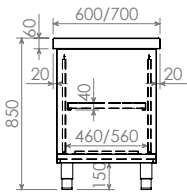

### CENTRALES

### MÓDULOS

DIM (mm)	CONSUMO/TENSIÓN	REF	PVP(€)	REF	PVP(€)
1200x600x850	2030w 230v/50-60Hz	IDNC2612	<b>2346</b>	IDMC2612	<b>1898</b>
1400x600x850	2030w 230v/50-60Hz	IDNC2614	<b>2496</b>	IDMC2614	<b>2024</b>
1600x600x850	3030w 230v/50-60Hz	IDNC2616	<b>2789</b>	IDMC2616	<b>2260</b>
1200x700x850	2030w 230v/50-60Hz	IDNC2712	<b>2409</b>	IDMC2712	<b>2168</b>
1400x700x850	2030w 230v/50-60Hz	IDNC2714	<b>2559</b>	IDMC2714	<b>2306</b>
1600x700x850	3030w 230v/50-60Hz	IDNC2716	<b>2864</b>	IDMC2716	<b>2576</b>
1800x700x850	3030w 230v/50-60Hz	IDNC2718	<b>3180</b>	IDMC2718	<b>2864</b>
2000x700x850	3030w 230v/50-60Hz	IDNC2720	<b>3531</b>	IDMC2720	<b>3180</b>

Fondo 600

Fondo 700



## GAMA AMPLIADA

MUEBLES/MÓDULOS CALIENTES  
GN 1/1 PUERTAS BATIENTES

- Encimera **reforzada** con omegas.
- **Frontal** soldado de 60mm en punto redondo, peto posterior de 100mm con radio sanitario.
- **Aislados** con lana de roca.
- **Bloque calórico** lateral con resistencias ventiladas. Interruptor ON/OFF luminoso y termostato digital 0°C / 90°C.
- **Puertas batientes** aisladas con bisagra pivotante, burlete perimetral para estanqueidad.
- **Estante** base con doble omega de refuerzo.
- Cuerpo de **guías** para 7 cubetas GN 1/1 h 65mm.
- **Patas** cilíndricas de acero inox 150mm regulables 50mm.



Cubetas y parrillas GN consultar páginas 105-107.

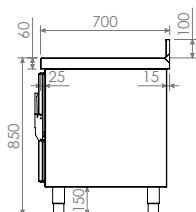

## CENTRALES

## MURALES

## MÓDULOS

DIM (mm)	CONSUMO/ TENSIÓN	REF	PVP(€)	REF	PVP(€)	REF	PVP(€)
1000x700x850 (2 Puertas)	1530w 230v/50-60Hz	IDNC7710	<b>2928</b>	IDNC4710	<b>3019</b>	IDMC4710	<b>2737</b>
1400x700x850 (3 Puertas)	2030w 230v/50-60Hz	IDNC7714	<b>3118</b>	IDNC4714	<b>3214</b>	IDMC4714	<b>2881</b>
1800x700x850 (4 Puertas)	3030w 230v/50-60Hz	IDNC7718	<b>3464</b>	IDNC4718	<b>3571</b>	IDMC4718	<b>3203</b>

SOPORTES PERFORADOS  
PARA MUEBLES CALIENTES

- Ideal para aumentar capacidad de carga en mesas calientes puertas correderas.

DIM (mm)	REF	PVP(€)
600x600x120mm	IDHC006 muebles 600	<b>127</b>
600x700x120mm	IDHC007 muebles 700	<b>161</b>





## NOVEDAD

## MÓDULOS CALIENTAPLATOS

- **Aislados** con lana de roca.
- **Bloque calórico** superior con resistencias ocultas con ventilador. Interruptor ON/OFF luminoso y termostato digital 0°C / 50°C.
- **Puertas batientes** aisladas con bisagra pivotante, burlete perimetral para estanqueidad.
- **Cajones** aislados con guías telescópicas.
- **Estante** base reforzado con omega central.
- **Patas** con taco regulable.

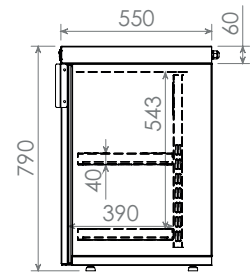

## SIMPLES

DIM (mm)		CONSUMO/TENSIÓN	REF	PVP(€)
500x550x790	1 puerta bat.	1030w 230v/50-60Hz	IDAC0011	1025
500x550x790	1 cajón + 1 puerta bat.	1030w 230v/50-60Hz	IDAC0021	1355
500x550x790	2 cajones	1030w 230v/50-60Hz	IDAC0022	1460

## DOBLE

DIM (mm)		CONSUMO/TENSIÓN	REF	PVP(€)
1000x550x790	2 puertas bat.	1530w 230v/50-60Hz	IDAC0012	1433



\*Modelo doble

## NOVEDAD

## CARROS ISOTÉRMICOS

- **Aislados** con lana de roca.
- Para 12 o 24 **bandejas** euronorm 530x370x110mm.
- **Puertas batientes** con cierre tipo Zammak, burlete perimetral para estanqueidad.
- 4 **ruedas** de Ø125mm (2 con freno).

Cubetas y parrillas GN consultar páginas 105-107.

DIM (mm)	CAPACIDAD	REF	PVP(€)
585x680x1680 simple	12 bandejas	IDAI0112	1455
1110x680x1680 doble	24 bandejas	IDAI0212	2375

## CARROS CALIENTES 90°

- **Aislados** con lana de roca.
- **Bloque** calórico inferior con resistencias ventiladas extraíbles y sistema de aire reforzado. Recipiente inferior para generar de humedad con sistema anti-ola.
- **Interruptor** ON/OFF luminoso y termostato digital 90°C.
- **Puertas batientes** aisladas con lana de roca, burlete perimetral para estanqueidad, con cierre Zamak y cerradura con llave.
- Cuerpo de **guías** interior para cubetas GN h 65mm.
- **Asa** lateral para transporte.
- 4 **ruedas** giratorias reforzadas de  $\varnothing 150\text{mm}$  (2 con freno).

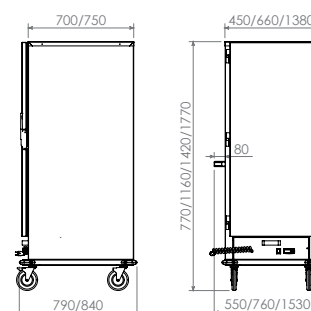

Cubetas y parrillas GN consultar páginas 105-107.



### GN2/1 - 1 Puerta

#### GAMA AMPLIADA

DIM (mm)	CAPACIDAD	CONSUMO/TENSIÓN	REF	PVP(€)
760x840x770	6 cubetas GN 2/1 12 cubetas GN 1/1	1530w / 230v / 50-60hz	IDAC9005	<b>2322</b>
760x840x1160	10 cubetas GN 2/1 20 cubetas GN 1/1	3060w / 230v / 50-60hz	IDAC9010	<b>2766</b>
760x840x1770	20 cubetas GN 2/1 40 cubetas GN 1/1	3060w / 230v / 50-60hz	IDAC9020	<b>3404</b>



### GN2/1 - 2 Puertas

DIM (mm)	CAPACIDAD	CONSUMO/TENSIÓN	REF	PVP(€)
1530x840x1770	20+20 cubetas GN 2/1 40+40 cubetas GN 1/1	3560w / 230v / 50-60hz	IDAC9040	<b>5198</b>



# 11.

Cubetas y parrillas GN consultar páginas 105-107.

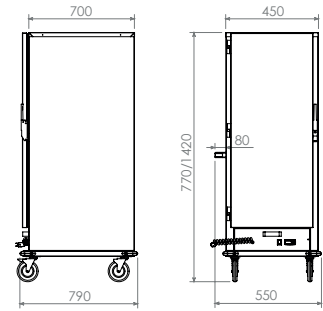

## GN1/1 - 1 Puerta

### GAMA AMPLIADA

DIM (mm)	CAPACIDAD	CONSUMO/TENSIÓN	REF	PVP(€)
550x790x770	8 cubetas GN 1/1	2030w / 230v / 50-60hz	IDAC9025	<b>2161</b>
550x790x1420	20 cubetas GN 1/1	2030w / 230v / 50-60hz	IDAC9030	<b>3088</b>



## PUERTA DE CRISTAL PARA CARROS CALIENTES

- **Marco** en acero inoxidable satinado, aislado con lana de roca.
- **Cierre** Zamak y cerradura con llave.
- **Cristal** templado de cámara.

REF		PVP(€)
IDACPC05	carro IDAC9005	<b>368</b>
IDACPC10	carro IDAC9010	<b>437</b>
IDACPC25	carro IDAC9025	<b>402</b>
IDACPC30	carro IDAC9030	<b>466</b>
IDACPC20	carro IDAC9020 / IDAC9040	<b>500</b>

Precio por unidad, sumado al precio del carro.



## BAÑOS MARÍA SOBREMESA

- **Cuba** con radios sanitarios para cubetas de 150mm de profundidad.
- **Aislados** con lana de roca.
- **Resistencias** ocultas. Interruptor ON/OFF luminoso y termostato digital 0°C / 90°C.
- **Desagüe** con grifo de bola en frontal.



Cubetas y parrillas GN consultar páginas 105-107.

DIM (mm)	CONSUMO/TENSIÓN	REF	PVP(€)
410x610x300 - 1GN1/1 (compacto)	800w / 230v / 50-60hz	IDNC2411	<b>460</b>
730x610x300 - 2GN1/1	1600w / 230v / 50-60hz	IDNC2421	<b>943</b>
1060x610x300 - 3GN1/1	2000w / 230v / 50-60hz	IDNC2431	<b>1202</b>
1390x610x300 - 4GN1/1	3000w / 230v / 50-60hz	IDNC2441	<b>1369</b>

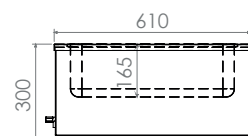

### GAMA AMPLIADA

## CARROS BAÑOS MARÍA

- **Cuba** con radios sanitarios para cubetas de 150mm de profundidad.
- **Aislados** con lana de roca.
- **Resistencias** ocultas. Interruptor ON/OFF luminoso y termostato digital 0°C / 90°C.
- **Reserva** caliente opcional con puertas batientes a 1 cara aisladas.
- **Desagüe** con grifo de bola inferior.
- **Estructura** en tubo 40x40mm con estante inferior soldado.
- **4 ruedas** giratorias de ø100mm (2 con freno).

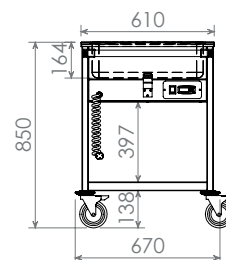

### SIN RESERVA

DIM (mm)	CONSUMO/TENSIÓN	REF	PVP(€)
720x465x850 - 1GN1/1	1600w / 230v / 50-60hz	IDTC2611	<b>1225</b>
830x670x850 - 2GN1/1	1600w / 230v / 50-60hz	IDTC2621	<b>1840</b>
1160x670x850 - 3GN1/1	2000w / 230v / 50-60hz	IDTC2631	<b>2139</b>
1490x670x850 - 4GN1/1	3000w / 230v / 50-60hz	IDTC2641	<b>2622</b>
1820x670x850 - 5GN1/1	3000w / 230v / 50-60hz	IDTC2651	<b>3180</b>



### NOVEDAD

### CON RESERVA

DIM (mm)	CONSUMO/TENSIÓN	REF	PVP(€)
830x670x850 - 2GN1/1	2630w / 230v / 50-60hz	IDTC3621	<b>3398</b>
1160x670x850 - 3GN1/1	3030w / 230v / 50-60hz	IDTC3631	<b>3701</b>
1490x670x850 - 4GN1/1	3530w / 230v / 50-60hz	IDTC3641	<b>4115</b>





# 11.



## CARROS CUBA FRÍA

- **Cuba** con cantos sanitarios para cubetas de 150mm de profundidad.
- **Refrigeradas** mediante serpentín oculto, aislamiento en poliestireno expandido densidad 30kg/m<sup>3</sup>.
- **Unidad condensadora** ubicada en parte inferior, termostato digital.
- 4 **ruedas** giratorias reforzadas de ø100mm (2 con freno).

Cubetas y parrillas GN consultar páginas 105-107.



Refrigerante R290.

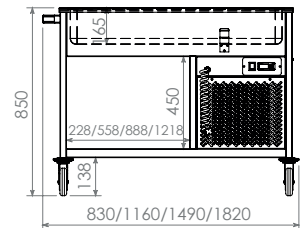

DIM (mm)	POTENCIA	CONSUMO/TENSIÓN	REF	PVP(€)
830x670x850 - 2GN1/1	1/4cv	235w / 230v / 50hz	IDTF2821	2570
1160x670x850 - 3GN1/1	1/4cv	235w / 230v / 50hz	IDTF2831	2881
1490x670x850 - 4GN1/1	1/4cv	327w / 230v / 50hz	IDTF2841	3203
1820x670x850 - 5GN1/1	1/4cv	327w / 230v / 50hz	IDTF2851	3554



## CARROS FRÍOS

- **Aislamiento** en poliestireno expandido densidad 30kg/m<sup>3</sup>.
- 1 puerta **batiente** aislada con cierre Zamak y cerradura con llave.
- **Cuerpo de guías** interior para cubetas GN 1/1 h 65mm.
- **Unidad condensadora** ubicada en parte inferior, evaporador tiro forzado, termostato digital, temperatura de trabajo 2°C/ 6°C.
- 4 **ruedas** giratorias reforzadas de ø150mm (2 con freno).
- **Asa** posterior para transporte.

Cubetas y parrillas GN consultar páginas 105-107.



Refrigerante R290.

DIM (mm)	CAPACIDAD	POTENCIA	CONSUMO/TENSIÓN	REF	PVP(€)
660x860x1620	20 cubetas GN 1/1	1/4cv	487w 230v/50Hz	IDAF0230	3743
780x950x1450	10 cubetas GN 2/1 20 cubetas GN 1/1	1/4cv	487w 230v/50Hz	IDAF0210	4198
780x950x1770	15 cubetas GN 2/1 30 cubetas GN 1/1	1/4cv	487w 230v/50Hz	IDAF0215	4497



# 12.

- Carros servicio y accesorios
- Carros portacubetas
- Carros desmontables
- Carros soldados
- Carros plate mate
- Carros bandejas autoservicio
- Carros bajos
- Carros cestas
- Carros bandejas y cubiertos
- Carros transporte de platos
- Carro tolva
- Cubos desperdicios



## CARROS DE SERVICIO

- **Manillares** de tubo curvado  $\varnothing 25\text{mm}$ .
- **Estantes** embutidos insonorizados, carga máxima 80kg por bandeja.
- **Ruedas** con taco expansivo diámetro 125mm (2 con freno) y 4 parachoques de protección.



**Totalmente soldados**  
Se suministran montados y soldados.

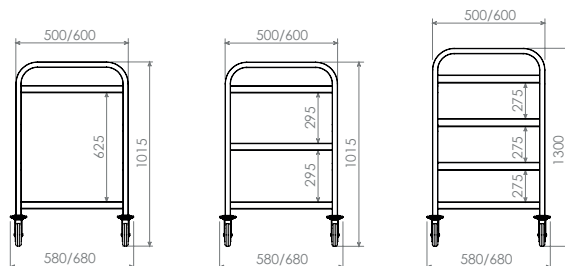

### ALTURA 1015

DIM (mm)	DIM ESTANTE (mm)
880x580x1015/1300	800x500
980x580x1015/1300	900x500
1080x680x1015/1300	1000x600

CARRO 2 ESTANTES	PVP(€)
IDT80240	528
IDT80250	612
IDT80260	786

### ALTURA 1300

CARRO 3 ESTANTES	PVP(€)
IDT80270	576
IDT80280	690
IDT80290	828

CARRO 4 ESTANTES	PVP(€)
IDT80300	876
IDT80310	972
IDT80320	1332

Estantes de mayor grosor, carga máxima 100kg por bandeja.

## CARRO DE SERVICIO DESBARACE

- Espacio para cubeta GN1/2.

**Cubeta no incluida, consultar página 105.**

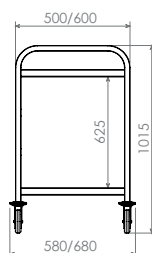

DIM (mm)	DIM ESTANTE (mm)	REF	PVP(€)
1080x680x1015	1000x600	IDT80680	912



# 12.

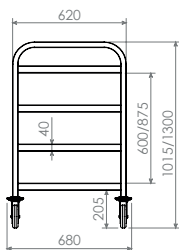

## CARROS DE SERVICIO REFORZADOS

- **Manillares** de tubo curvado 30x30mm.
- **Estantes** embutidos insonorizados, carga máxima 140kg por bandeja.
- **Ruedas** diámetro 125mm (2 con freno) y 4 parachoques de protección.



**Totalmente soldados**  
Se suministran montados y soldados.

DIM (mm)	DIM ESTANTE (mm)	REF	PVP(€)
1080x680x1015 - 2 niveles	1020x620	IDT89300	<b>948</b>
1080x680x1015 - 3 niveles	1020x620	IDT89310	<b>1116</b>
1080x680x1300 - 4 niveles	1020x620	IDT89320	<b>1608</b>



## SOPORTES LATERALES PARA CARRO DE SERVICIO

- Adaptables a todos nuestros carros de servicio.

CARACTERÍSTICAS	REF	PVP(€)
Soporte lateral cubiertos	IDT80374	<b>72</b>

## CARROS PORTACUBETAS GN

- 4 **ruedas** ø125mm (2 con freno) y 4 parachoques de protección.
- Ideales para almacenaje y transporte de alimentos preparados.

**Cubetas no incluidas, consultar página 105.**

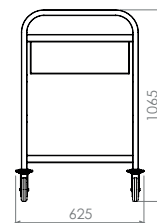

**Totalmente soldados**  
Se suministran montados y soldados.

DIM (mm)	CARACTERÍSTICAS	REF	PVP(€)
750x625x1065	capacidad 2 GN1/1	IDT80380	<b>708</b>
1100x625x1065	capacidad 3 GN1/1	IDT80390	<b>780</b>



## CARROS DESMONTADOS

- **Estructura** tubo 25x25mm.
- **Ruedas** ø125mm (2 con freno) y 4 parachoques de protección.
- Robustos y sólidos.

Cubetas y bandejas no incluidas, consultar páginas 105-106.

DIM (mm)	GASTRONORM	REF	PVP(€)
455x635x1710	GN 1/1 - 17 Guías	IDT80470	<b>744</b>
660x755x1710	GN 2/1 - 17 Guías	IDT80480	<b>762</b>

DIM (mm)	BANDEJAS PASTELERAS	REF	PVP(€)
525x700x1710	600x400 -15 Guías	IDT80870	<b>774</b>
525x700x1710	600x400 -20 Guías	IDT80880	<b>798</b>

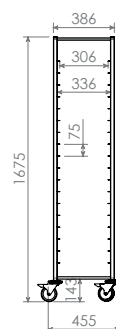

Se suministran desmontados  
Rápido y fácil montaje.



## CARROS SOLDADOS

- **Estructura** tubo 25x25mm.
- **Ruedas** ø125mm (2 con freno) y 4 parachoques de protección.

Cubetas y bandejas no incluidas, consultar páginas 105-106.

DIM (mm)	GASTRONORM	REF	PVP(€)
455x635x1675	GN 1/1 - 17 Guías	IDT80430	<b>804</b>
810x635x1675	DOBLE - GN 1/1 - 17 Guías	IDT80670	<b>1488</b>
660x755x1675	GN 2/1 - 17 Guías	IDT80440	<b>828</b>

DIM (mm)	GASTRONORM	REF	PVP(€)
525x700x1675	600x400 -15 Guías	IDT80840	<b>810</b>
525x700x1675	600x400 -20 Guías	IDT80850	<b>834</b>

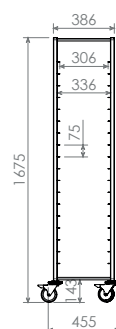

Totalmente soldados  
Se suministran montados y soldados.



# 12.

## CARROS EMPLATAR **PLATE MATE**

- Plásticos especiales, caucho Santoprene y aluminio anodizado.
- 4 **ruedas** ø125mm (2 con freno).
- Ajuste altura de platos mediante regulador superior.
- Ideales para almacenaje y transporte de platos.
- Robustos y sólidos.

\* **Platos no incluidos.**



**Se suministran desmontados**  
Rápido y fácil montaje.



Doble

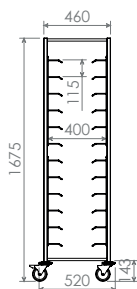

**Totalmente soldados**  
Se suministran montados y soldados.



Simple plegable



Simple

DIM (mm)	CARACTERÍSTICAS	REF	PVP(€)
480x480x1490	SIMPLE Capacidad 60 platos PLEGABLE	IDT80060	<b>1368</b>
700x700x1890	SIMPLE Capacidad 84 platos PLEGABLE	IDT80110	<b>1632</b>
640x640x1860	SIMPLE Capacidad 84 platos	IDT80125	<b>1740</b>
1200x600x1860	DOBLE Capacidad 84 + 84 platos	IDT80180	<b>2322</b>

### NUEVO MODELO

## CARROS BANDEJAS AUTOSERVICIO

- **Estructura** tubo 25x25mm.
- 4 **ruedas** diámetro 125mm (2 con freno) y 4 parachoques de protección.
- Capacidad para **bandejas** de 335mm hasta 400mm de ancho.
- **Plafones laterales** opcionales de composite + aluminio.

**Cubetas y bandejas no incluidas, consultar páginas 105-106.**

### SIMPLES

DIM (mm)	CARACTERÍSTICAS	REF	PVP(€)
520x640x1675	365/420mm -12 Guías	IDT80950	<b>810</b>
520x640x1675	365/420mm -12 Guías - plafones laterales	IDT80951	<b>1182</b>

### NOVEDAD

### DOBLES

DIM (mm)	CARACTERÍSTICAS	REF	PVP(€)
960x640x1675	365/420mm -24 Guías	IDT80952	<b>1298</b>
960x640x1675	365/420mm -24 Guías plafones laterales	IDT80953	<b>1670</b>

## GAMA AMPLIADA

## CARROS BAJOS

- **Estructura** tubo de 25x25mm.
- **Ruedas** Ø125 mm (2 con freno) y 4 parachoques de protección.

Cubetas no incluidas, consultar páginas 105-106



**Totalmente soldados**  
Se suministran montados y soldados.

DIM (mm)	GASTRONORM	REF	PVP(€)
455x635x900	GN 1/1 - 7 Guías	IDT80540	642
810x635x900	DOBLE - GN 1/1 - 7 Guías	IDT80780	1188
660x755x900	GN 2/1 - 7 Guías	IDT80550	720

DIM (mm)	BANDEJAS PASTELERAS	REF	PVP(€)
525x700x900	600x400 - 7 Guías	IDT80860	678

DIM (mm)	DISTRIBUCIÓN GN	REF	PVP(€)
900x570x1070	GN 1/1 - 48 guías + 3 soportes sup.	IDT80560	1205

DIM (mm)	GRAN CARGA	REF	PVP(€)
900x570x1070	Carga máxima 350 kg.	IDT80570	912



## CARROS PARA CESTAS

- **Ruedas** Ø125 mm (2 con freno) y 4 parachoques de protección.



**Totalmente soldados**  
Se suministran montados y soldados.

DIM (mm)	BASE CESTAS	REF	PVP(€)
640x640x1065	Con Asa	IDT80580	492
640x640x165	Sin Asa	IDT80590	324

DIM (mm)	CARRO GUÍAS	REF	PVP(€)
640x633x1160	5 Guías	IDT80750	618
640x633x1710	9 Guías	IDT80760	942





**Totalmente soldados**  
Se suministran montados y soldados.



## CARROS PARA BANDEJAS Y CUBIERTOS

- **Estructura** tubo 25x25mm.
- 4 **ruedas** Ø125mm (2 con freno), 4 parachoques de protección.
- **Capacidad** para 4GN 1/3.

**Cubetas no incluidas, consultar página 106**

DIM (mm)	CARACTERÍSTICAS	REF	PVP(€)
810x570x1065	Capacidad para 4 GN 1/3	IDT80740	<b>642</b>

### NOVEDAD

## CARROS TRANSPORTE DE PLATOS

- Para platos de hasta Ø32cm.
- **Estantes** reforzados.
- **Separadores** varilla regulables opcionales.
- 4 **ruedas** Ø125mm (2 con freno) y parachoques de protección.

DIM (mm)	REF	PVP(€)
1200x390x900- simple	IDT80010	<b>778</b>
1200x755x900- doble	IDT80020	<b>949</b>
Separador varilla	IDT80001	<b>60</b>

\*precio por unidad

## CARRO TOLVA

- **Tapa** superior extraíble.
- **Recipiente** estanco con radios sanitarios.
- 4 **ruedas** Ø60mm (2 con freno).

DIM (mm)	REF	PVP(€)
610x400x725- 115 litros	IDT08060	<b>672</b>

## CUBOS DESPERDICIOS

- **Moldura** de caucho perimetral de protección.
- **Mecanismo apertura** de tapa en modelo con pedal, tapa superior extraíble.
- **Asas** laterales.
- 3 **ruedas** Ø50mm.

DIM (mm)	CARACTERÍSTICAS	REF	PVP(€)
Ø390x600 60 litros	Con tapa	IDT80910	<b>372</b>
Ø460x700 100 litros	Con tapa	IDT80920	<b>414</b>
Ø390x600 60 litros	Con tapa y pedal	IDT80930	<b>402</b>
Ø460x700 100 litros	Con tapa y pedal	IDT80940	<b>444</b>









# 13.

- Muebles cuba fría
- Muebles placa fría
- Muebles isla central fría
- Vitrinas refrigeradas
- Muebles baño maría
- Muebles placa vitrocerámica
- Muebles isla central
- Muebles reserva caliente
- Muebles neutros
- Plafones continuación
- Carros dispensadores
- Muebles bandejas, cubiertos y pan
- Muebles vasos
- Pantallas y cristales
- Deslizadores
- Decoración
- Accesorios

**GAMA AMPLIADA  
Y RENOVADA**
**MUEBLES AUTOSERVICIO  
CUBA FRÍA SIN RESERVA**

- **Frontal** soldado de 60mm en punto redondo.
- **Cuba** con radios sanitarios para cubetas de 150mm de profundidad.
- **Refrigeradas** mediante serpentín oculto.
- **Aislamiento** con poliestileno expandido.
- **Desagüe** inferior en cuba.
- **Termostato** digital.
- **Decoración frontal** en acero inox con posibilidad de panelado decorativo.
- **Patas** cilíndricas de acero inox 150mm regulables 50mm.

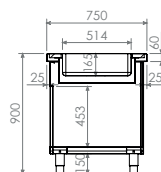

Cubetas y parrillas GN  
consultar páginas 105-107.

Refrigerante R290.



\* Deslizador bandejas no incluido.

DIM (mm)	CONSUMO/ TENSIÓN	REF	PVP(€)
900x750x900 - 2GN1/1	235w 230v-50hz	IDS21021	<b>2754</b>
1200x750x900 - 3GN1/1	235w 230v-50hz	IDS21031	<b>2984</b>
1600x750x900 - 4GN1/1	327w 230v-50hz	IDS21041	<b>3324</b>
2000x750x900 - 5GN1/1	473w 230v-50hz	IDS21051	<b>4117</b>
2200x750x900 - 6GN1/1	473w 230v-50hz	IDS21061	<b>4324</b>

**MUEBLES AUTOSERVICIO  
CUBA FRÍA CON RESERVA**

- **Frontal** soldado de 60mm en punto redondo.
- **Cuba** con radios sanitarios para cubetas de 150mm de profundidad.
- **Refrigeradas** mediante serpentín oculto.
- **Aislamiento** con poliestileno expandido.
- **Desagüe** inferior en cuba.
- **Termostato** digital.
- **Reserva inferior** refrigerada, con guías para cubetas GN1/1 y puertas batientes aisladas.
- **Decoración frontal** en acero inox con posibilidad de panelado decorativo.
- **Patas** cilíndricas de acero inox 150mm regulables 50mm.

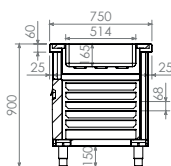

Refrigerante R290.



\* Deslizador bandejas no incluido.

DIM (mm)	CONSUMO/ TENSIÓN	REF	PVP(€)
1200x750x900 - 3GN1/1	327w 230v-50hz	IDS21131	<b>4330</b>
1600x750x900 - 4GN1/1	473w 230v-50hz	IDS21141	<b>4508</b>
2000x750x900 - 5GN1/1	473w 230v-50hz	IDS21151	<b>5175</b>
2200x750x900 - 6GN1/1	692w 230v-50hz	IDS21161	<b>5445</b>



Cubetas y parrillas GN  
consultar páginas 105-107.



Refrigerante R290.

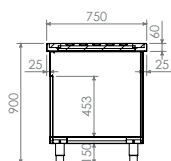

### GAMA AMPLIADA Y RENOVADA

## MUEBLES AUTOSERVICIO PLACA FRÍA SIN RESERVA

- **Frontal** soldado de 60mm en punto redondo.
- **Placa** con roldana salvaaguas perimetral.
- **Refrigeradas** mediante serpentín oculto.
- **Aislamiento** con poliestileno expandido.
- **Desagüe** inferior en cuba.
- **Termostato** digital.
- **Decoración frontal** en acero inox con posibilidad de panelado decorativo.
- **Patas** cilíndricas de acero inox 150mm regulables 50mm.

\* Deslizador bandejas no incluido.



DIM (mm)	CONSUMO/ TENSIÓN	REF	PVP(€)
900x750x900 - 2GN1/1	235w 230v-50hz	IDS31021	<b>2547</b>
1200x750x900 - 3GN1/1	235w 230v-50hz	IDS31031	<b>2766</b>
1600x750x900 - 4GN1/1	327w 230v-50hz	IDS31041	<b>2921</b>
2000x750x900 - 5GN1/1	473w 230v-50hz	IDS31051	<b>3502</b>
2200x750x900 - 6GN1/1	473w 230v-50hz	IDS31061	<b>3801</b>

## MUEBLES AUTOSERVICIO PLACA FRÍA CON RESERVA

- **Frontal** soldado de 60mm en punto redondo.
- **Placa** con roldana salvaaguas perimetral.
- **Refrigeradas** mediante serpentín oculto.
- **Aislamiento** con poliestileno expandido.
- **Desagüe** inferior en cuba.
- **Termostato** digital.
- **Reserva inferior** refrigerada, con guías para cubetas GN1/1 y puertas batientes aisladas.
- **Decoración frontal** en acero inox con posibilidad de panelado decorativo.
- **Patas** cilíndricas de acero inox 150mm regulables 50mm.

\* Deslizador bandejas no incluido.



Refrigerante R290.

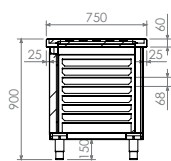

DIM (mm)	CONSUMO/ TENSIÓN	REF	PVP(€)
1200x750x900 - 3GN1/1	327w 230v-50hz	IDS31131	<b>3870</b>
1600x750x900 - 4GN1/1	473w 230v-50hz	IDS31141	<b>4117</b>
2000x750x900 - 5GN1/1	473w 230v-50hz	IDS31151	<b>4721</b>
2200x750x900 - 6GN1/1	692w 230v-50hz	IDS31161	<b>5060</b>

GAMA AMPLIADA  
Y RENOVADA

## MUEBLES AUTOSERVICIO ISLA CENTRAL FRÍA

- Mismas características técnicas y constructivas que los modelos sin reserva.
- **Decoración** a 2 caras en acero inox con posibilidad de panelado decorativo.



Refrigerante R290.

\* Deslizadores bandejas no incluidos.

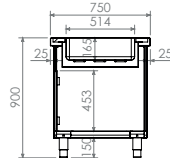

### ISLA CENTRAL CUBA FRÍA

DIM (mm)	CONSUMO/ TENSIÓN	REF	PVP(€)
900x750x900 - 2GN1/1	235w 230v-50hz	IDS22021	<b>2892</b>
1200x750x900 - 3GN1/1	235w 230v-50hz	IDS22031	<b>3145</b>
1600x750x900 - 4GN1/1	327w 230v-50hz	IDS22041	<b>3502</b>
2000x750x900 - 5GN1/1	473w 230v-50hz	IDS22051	<b>4336</b>
2200x750x900 - 6GN1/1	473w 230v-50hz	IDS22061	<b>4554</b>



### ISLA CENTRAL PLACA FRÍA

DIM (mm)	CONSUMO/ TENSIÓN	REF	PVP(€)
900x750x900 - 2GN1/1	235w 230v-50hz	IDS32021	<b>2754</b>
1200x750x900 - 3GN1/1	235w 230v-50hz	IDS32031	<b>2996</b>
1600x750x900 - 4GN1/1	327w 230v-50hz	IDS32041	<b>3186</b>
2000x750x900 - 5GN1/1	473w 230v-50hz	IDS32051	<b>3686</b>
2200x750x900 - 6GN1/1	473w 230v-50hz	IDS32061	<b>4002</b>

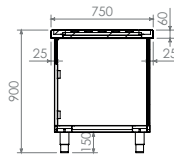

### SOPORTE LATERAL PLATOS ISLA CENTRAL

DIM (mm)	REF	PVP(€)
600x350x280	IDS82280	<b>265</b>

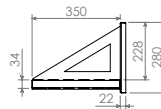



Cubetas y parrillas GN  
consultar páginas 105-107.

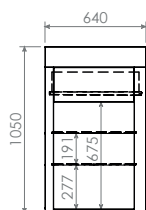

Refrigerante R290.



Vista trasera

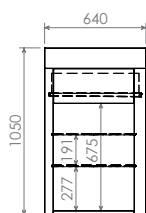

Refrigerante R290.



Vista frontal

## GAMA RENOVADA

### VITRINAS AUTOSERVICIO REFRIGERADAS BASE ABIERTA

- **Iluminación** interior LED.
- **Laterales y puertas** correderas posteriores de cristal, puertas frontales abatibles de metacrilato transparente.
- **2 niveles** de estante de rejillas inox.
- **Refrigeradas** mediante evaporador tiro forzado ubicado en techo, unidad condensadora ubicada en parte superior, desagüe por gravedad.
- **Temperatura** recomendada de trabajo 8°C / 10°C.
- **Se suministran montadas** en caso de compra conjunta con autoservicios cubas o placas frías.

\* Elementos sensibles a la condensación, recomendación de ambientes de 28°C y 60% humedad máximo.

DIM (mm)	CONSUMO/ TENSIÓN	REF	PVP(€)
1150x640x1050 - 3GN1/1	692w 230v-50hz	IDS60131	<b>4416</b>
1550x640x1050 - 4GN1/1	692w 230v-50hz	IDS60141	<b>4905</b>
1950x640x1050 - 5GN1/1	692w 230v-50hz	IDS60151	<b>5181</b>
2150x640x1050 - 6GN1/1	824w 230v-50hz	IDS60161	<b>5451</b>

### VITRINAS AUTOSERVICIO REFRIGERADAS CON BASE AISLADA

- **Iluminación** interior LED.
- **Laterales y puertas** correderas posteriores de cristal, puerta frontales abatibles de metacrilato transparente.
- **2 niveles** de estante de rejillas inox.
- **Refrigeradas** mediante evaporador tiro forzado ubicado en techo, unidad condensadora ubicada en parte superior, desagüe por gravedad.
- **Temperatura** recomendada de trabajo 8°C / 10°C.
- **Base inferior** con salvaaguas tipo roldana y aislada con poliestireno expandido.

\* Elementos sensibles a la condensación, recomendación de ambientes de 28°C y 60% humedad máximo.

DIM (mm)	CONSUMO/ TENSIÓN	REF	PVP(€)
1150x640x1050 - 3GN1/1	692w 230v-50hz	IDS61131	<b>4652</b>
1550x640x1050 - 4GN1/1	692w 230v-50hz	IDS61141	<b>5164</b>
1950x640x1050 - 5GN1/1	692w 230v-50hz	IDS61151	<b>5457</b>
2150x640x1050 - 6GN1/1	824w 230v-50hz	IDS61161	<b>5739</b>



GAMA AMPLIADA  
Y RENOVADA

## MUEBLES AUTOSERVICIO BAÑO MARÍA HÚMEDO SIN RESERVA

- **Frontal** soldado de 60mm en punto redondo.
- **Cuba** con radios sanitarios para cubetas de 150mm de profundidad
- **Aislamiento** con lana de roca.
- **Resistencias** ocultas en contacto con cuba.
- **Interruptor** ON/OFF luminoso y termostato digital 0°/90°.
- **Llenado** mediante electroválvula y desagüe por gravedad.
- **Decoración frontal** en acero inox con posibilidad de panelado decorativo.
- **Patas** cilíndricas de acero inox 150mm regulables 50mm.

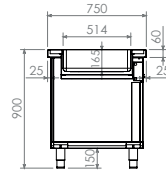

\* Deslizador bandejas no incluido.

DIM (mm)	CONSUMO/ TENSIÓN	REF	PVP(€)
900x750x900 - 2GN1/1	1600w 230v/50-60hz	IDS11021	<b>2421</b>
1200x750x900 - 3GN1/1	2000w 230v/50-60hz	IDS11031	<b>2628</b>
1600x750x900 - 4GN1/1	3000w 230v/50-60hz	IDS11041	<b>2996</b>
2000x750x900 - 5GN1/1	3600w 230v/50-60hz	IDS11051	<b>3743</b>
2200x750x900 - 6GN1/1	3600w 230v/50-60hz	IDS11061	<b>4083</b>



## MUEBLES AUTOSERVICIO BAÑO MARÍA HÚMEDO CON RESERVA

- **Frontal** soldado de 60mm en punto redondo.
- **Cuba** con radios sanitarios para cubetas de 150mm de profundidad
- **Aislamiento** con lana de roca.
- **Resistencias** ocultas en contacto con cuba.
- **Interruptor** ON/OFF luminoso y doble termostato digital 0°/90°.
- **Llenado** mediante electroválvula y desagüe por gravedad.
- **Reserva** con puertas correderas frontales.
- **Decoración frontal** en acero inox con posibilidad de panelado decorativo.
- **Patas** cilíndricas de acero inox 150mm regulables 50mm.

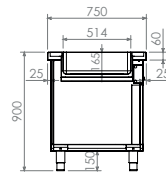

\* Deslizador bandejas no incluido.

DIM (mm)	CONSUMO/ TENSIÓN	REF	PVP(€)
1200x750x900 - 3GN1/1	3530w 230v/50-60hz	IDS11131	<b>3398</b>
1600x750x900 - 4GN1/1	4530w 400v/50-60hz	IDS11141	<b>3801</b>
2000x750x900 - 5GN1/1	5130w 400v/50-60hz	IDS11151	<b>4617</b>
2200x750x900 - 6GN1/1	5630w 400v/50-60hz	IDS11161	<b>5187</b>



Cubetas y parrillas GN  
consultar páginas 105-107.

Cubetas y parrillas GN  
consultar páginas 105-107.

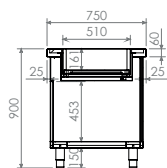

### GAMA AMPLIADA Y RENOVADA

## MUEBLES AUTOSERVICIO BAÑO MARÍA SECO SIN RESERVA

- **Frontal** soldado de 60mm en punto redondo.
- **Cuba** con radios sanitarios para cubetas de 150mm de profundidad
- **Aislamiento** con lana de roca.
- **Resistencias** vistas con chapa perforada de protección.
- **Interruptor** ON/OFF luminoso y termostato digital 0°/90°.
- **Decoración frontal** en acero inox con posibilidad de panelado decorativo.
- **Patas** cilíndricas de acero inox 150mm regulables 50mm.

\* Deslizador bandejas no incluido.

DIM (mm)	CONSUMO/ TENSIÓN	REF	PVP(€)
900x750x900 - 2GN1/1	800w 230v/50-60hz	IDS13021	<b>2323</b>
1200x750x900 - 3GN1/1	1200w 230v/50-60hz	IDS13031	<b>2524</b>
1600x750x900 - 4GN1/1	1600w 230v/50-60hz	IDS13041	<b>2875</b>
2000x750x900 - 5GN1/1	2000w 230v/50-60hz	IDS13051	<b>3594</b>
2200x750x900 - 6GN1/1	2400w 230v/50-60hz	IDS13061	<b>3922</b>

## MUEBLES AUTOSERVICIO BAÑO MARÍA SECO CON RESERVA

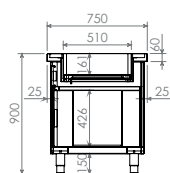

- **Frontal** soldado de 60mm en punto redondo.
- **Cuba** con radios sanitarios para cubetas de 150mm de profundidad
- **Aislamiento** con lana de roca.
- **Resistencias** vistas con chapa perforada de protección.
- Doble **Interruptor** ON/OFF luminoso y doble termostato digital 0°/90°.
- **Reserva** con puertas correderas frontales.
- **Decoración frontal** en acero inox con posibilidad de panelado decorativo.
- **Patas** cilíndricas de acero inox 150mm regulables 50mm.

\* Deslizador bandejas no incluido.

DIM (mm)	CONSUMO/ TENSIÓN	REF	PVP(€)
1200x750x900 - 3GN1/1	2700w 230v/50-60hz	IDS13131	<b>3186</b>
1600x750x900 - 4GN1/1	2900w 230v/50-60hz	IDS13141	<b>3577</b>
2000x750x900 - 5GN1/1	4000w 400v/50-60hz	IDS13151	<b>4364</b>
2200x750x900 - 6GN1/1	4930w 400v/50-60hz	IDS13161	<b>4778</b>



GAMA AMPLIADA  
Y RENOVADA

## MUEBLES AUTOSERVICIO PLACA VITROCERÁMICA SIN RESERVA

- **Frontal** soldado de 60mm en punto redondo.
- **Placa superior** de cristal templado negro.
- **Aislamiento** con lana de roca.
- **Resistencias** ocultas en contacto con cristal.
- **Interruptor** ON/OFF luminoso y termostato digital 0°/130°.
- **Decoración frontal** en acero inox con posibilidad de panelado decorativo.
- **Patas** cilíndricas de acero inox 150mm regulables 50mm.

\* Deslizador bandejas no incluido.

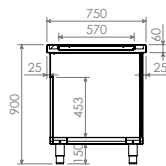

Cubetas y parrillas GN  
consultar páginas 105-107.



DIM (mm)	CONSUMO/TENSIÓN	REF	PVP(€)
900x750x900 - 2GN1/1	900w 230v/50-60hz	IDS12021	<b>2680</b>
1200x750x900 - 3GN1/1	1350w 230v/50-60hz	IDS12031	<b>2910</b>
1600x750x900 - 4GN1/1	1800w 230v/50-60hz	IDS12041	<b>3393</b>
2000x750x900 - 5GN1/1	2250w 230v/50-60hz	IDS12051	<b>4031</b>
2200x750x900 - 6GN1/1	2700w 230v/50-60hz	IDS12061	<b>4554</b>

## MUEBLES AUTOSERVICIO PLACA VITROCERÁMICA CON RESERVA

- **Frontal** soldado de 60mm en punto redondo.
- **Placa superior** de cristal templado negro.
- **Aislamiento** con lana de roca.
- **Resistencias** ocultas en contacto con cristal.
- **Interruptor** ON/OFF luminoso y termostato digital 0°/130°.
- **Reserva** con puertas correderas frontales.
- **Decoración frontal** en acero inox con posibilidad de panelado decorativo.
- **Patas** cilíndricas de acero inox 150mm regulables 50mm.

\* Deslizador bandejas no incluido.

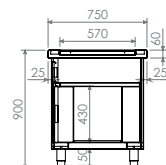

DIM (mm)	CONSUMO/TENSIÓN	REF	PVP(€)
1200x750x900 - 3GN1/1	2880w 230v/50-60hz	IDS12131	<b>3565</b>
1600x750x900 - 4GN1/1	3330w 400v/50-60hz	IDS12141	<b>4083</b>
2000x750x900 - 5GN1/1	4280w 400v/50-60hz	IDS12151	<b>4790</b>
2200x750x900 - 6GN1/1	4730w 400v/50-60hz	IDS12161	<b>5399</b>

MUEBLES AUTOSERVICIO  
ISLA CENTRAL

- Mismas características técnicas y constructivas que modelos sin reserva.
- **Decoración** a 2 caras en acero inox con posibilidad de panelado decorativo.

\* Deslizadores bandejas no incluidos.



## BAÑO MARÍA HÚMEDO

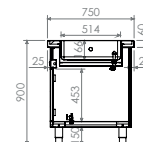

DIM (mm)	CONSUMO/ TENSIÓN	REF	PVP(€)
900x750x900 - 2GN1/1	1600w 230v/50-60hz	IDS11521	<b>2685</b>
1200x750x900 - 3GN1/1	2000w 230v/50-60hz	IDS11531	<b>2921</b>
1600x750x900 - 4GN1/1	3000w 230v/50-60hz	IDS11541	<b>3329</b>
2000x750x900 - 5GN1/1	3600w 230v/50-60hz	IDS11551	<b>4157</b>
2200x750x900 - 6GN1/1	3600w 230v/50-60hz	IDS11561	<b>4537</b>

## BAÑO MARÍA SECO

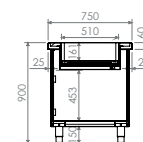

DIM (mm)	CONSUMO/ TENSIÓN	REF	PVP(€)
900x750x900 - 2GN1/1	800w 230v/50-60hz	IDS13521	<b>2582</b>
1200x750x900 - 3GN1/1	1200w 230v/50-60hz	IDS13531	<b>2806</b>
1600x750x900 - 4GN1/1	1600w 230v/50-60hz	IDS13541	<b>2875</b>
2000x750x900 - 5GN1/1	2000w 230v/50-60hz	IDS13551	<b>3197</b>
2200x750x900 - 6GN1/1	2400w 230v/50-60hz	IDS13561	<b>4359</b>

## PLACA CALIENTE VITROCERÁMICA

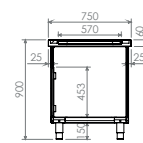

DIM (mm)	CONSUMO/ TENSIÓN	REF	PVP(€)
900x750x900 - 2GN1/1	900w 230v/50-60hz	IDS12521	<b>2979</b>
1200x750x900 - 3GN1/1	1350w 230v/50-60hz	IDS12531	<b>3237</b>
1600x750x900 - 4GN1/1	1800w 230v/50-60hz	IDS12541	<b>3772</b>
2000x750x900 - 5GN1/1	2250w 230v/50-60hz	IDS12551	<b>4479</b>
2200x750x900 - 6GN1/1	2700w 230v/50-60hz	IDS12561	<b>5060</b>

## SOPORTE LATERAL PLATOS ISLA CENTRAL

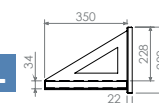

DIM (mm)	REF	PVP(€)
600x350x280mm	IDS82280	<b>265</b>

## MUEBLES AUTOSERVICIO RESERVA CALIENTE

- **Frontal** soldado de 60mm en punto redondo.
- **Aislamiento** con lana de roca,.
- **Resistencias** ventiladas en un lateral.
- **Interruptor** ON/OFF luminoso y termostato digital 0°/90°.
- **Reserva** con puertas correderas frontales.
- **Decoración frontal** en acero inox con posibilidad de panelado decorativo.
- **Patas** cilíndricas de acero inox 150mm regulables 50mm.

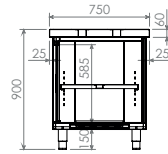

\* Deslizador bandejas no incluido.

DIM (mm)	CONSUMO/ TENSIÓN	REF	PVP(€)
1200x750x900 - 3GN1/1	2030w 230v/50-60hz	IDS10331	<b>2185</b>
1600x750x900 - 4GN1/1	2030w 230v/50-60hz	IDS10341	<b>2766</b>
2000x750x900 - 5GN1/1	3030w 230v/50-60hz	IDS10351	<b>2898</b>



## MUEBLES AUTOSERVICIO NEUTRO

- **Frontal** soldado de 60 mm en punto redondo.
- **Estante** base con doble omega de refuerzo, estante regulable intermedio reforzado con omega central.
- **Decoración frontal** en acero inox con posibilidad de panelado decorativo.
- **Patas** cilíndricas de acero inox 150mm regulables 50mm, 6 patas y **refuerzo** central a partir de 2000mm.

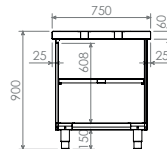

\* Deslizador bandejas no incluido.

DIM (mm)	REF	PVP(€)
400x750x900	IDS41004	<b>891</b>
800x750x900	IDS41008	<b>1075</b>
1200x750x900	IDS41012	<b>1185</b>
1600x750x900	IDS41016	<b>1386</b>
2000x750x900	IDS41020	<b>1507</b>
2200x750x900	IDS41022	<b>1645</b>







Angular exterior 90°



Angular interior 90°

## MUEBLES AUTOSERVICIO ANGULAR

- **Frontal** soldado de 60 mm en punto redondo.
- **Estante** base con doble omega de refuerzo, estante regulable intermedio reforzado con omega central.
- **Decoración frontal** en acero inox con posibilidad de panelado decorativo.
- **Patas** cilíndricas de acero inox 150mm regulables 50mm.

\* Deslizador bandejas no incluido.

	DIM (mm)	REF	PVP(€)
Angular exterior	1180x750x900	IDS41115	1271

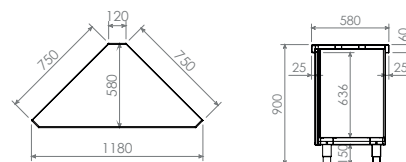

	DIM (mm)	REF	PVP(€)
Angular interior	1500x750x900	IDS41116	1397

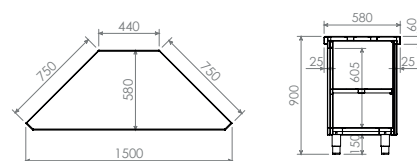

## MUEBLES AUTOSERVICIO NEUTRO CAJA

- **Frontal** soldado de 60 mm en punto redondo.
- **Estante** base con doble omega de refuerzo.
- **Cajón** guías telescópicas con cerradura.
- **Decoración frontal** en acero inox con posibilidad de panelado decorativo.
- **Patas** cilíndricas de acero inox 150mm regulables 50mm.

\* Deslizador bandejas no incluido.

	DIM (mm)	REF	PVP(€)
Derecha	1200x750x900	IDS4116D	1277
Izquierda	1200x750x900	IDS4116I	1277

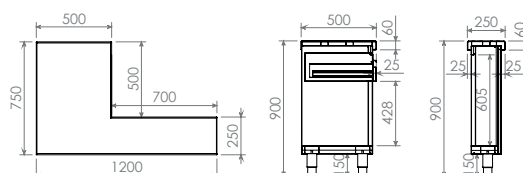

Módulo derecha

## PLAFONES CONTINUACIÓN LÍNEA AUTOSERVICIO

- **Frontal** soldado de 60mm.
- **Plafones** con espacio posterior para carros dispensadores.
- **Base de enchufe** para alimentación eléctrica.
- **Decoración frontal** en acero inox con posibilidad de panelado decorativo.
- **Sujeción** entre laterales de muebles autoservicio.

DIM (mm)	REF	PVP(€)
600x100x900	IDS41106	598
1200x100x900	IDS41112	880



## CARRO DISPENSADOR BANDEJAS AUTOSERVICIO A NIVEL CONSTANTE

- Para **bandejas** autoservicio.
- **Carga máxima** 80kg.
- 4 **ruedas** giratorias de  $\varnothing 100$  (2 con freno).

DIM (mm)	REF	PVP(€)
590x590x900	IDS88001	1323



## CARROS DISPENSADORES PLATOS NEUTRO/CALIENTE A NIVEL CONSTANTE

- Para **platos** de  $\varnothing 240$  a  $\varnothing 320$ mm.
- **Regulación** de nivel mediante muelles.
- **Carga máxima** 70kg.
- Modelo caliente **aislado** con lana de roca y resistencias inferiores.
- **Interruptor** ON/OFF luminoso y termostato digital  $0^{\circ}/90^{\circ}$ .
- 4 **ruedas** giratorias de  $\varnothing 100$  (2 con freno).

DIM (mm)	CONSUMO/ TENSIÓN	REF	PVP(€)
480x840x940 neutro	-	IDS88002	1472
480x840x940 caliente	2000W 230V 50/60HZ	IDS88003	1938

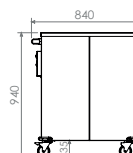

## MUEBLES AUTOSERVICIO BANDEJAS, CUBIERTOS Y PAN

- **Tolva** de pan con puerta posterior y cubertero superior.
- 1 **estante** base + 1 intermedio para bandejas, cubiertos y vasos.
- 4 **ruedas** giratorias de  $\varnothing 125$  (2 con freno).

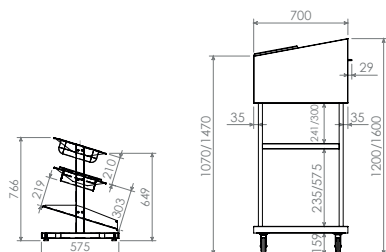

DESCRIPCIÓN	DIM (mm)	REF	PVP(€)
Dispensador de pie bandejas, cubiertos y pan	800x700x1200	IDS51107	<b>1691</b>
Dispensador de pie bandejas, cubiertos y pan	800x700x1600	IDS51108	<b>1714</b>
Dispensador sobremesa bandejas, cubiertos y vasos	650x565x770	IDS51109	<b>811</b>
Tolva pan	800x700x400	IDS51300	<b>788</b>



Modelo 1600



Modelo 1200



Modelo sobremesa

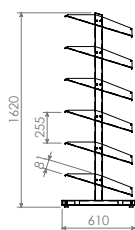

## MUEBLES AUTOSERVICIO VASOS

- **Estantes** inclinados con varilla frontal anticaída.
- **Taco** regulable inferior.

DESCRIPCIÓN	DIM (mm)	REF	PVP(€)
Dispensador vasos de sobremesa	700x600x700	IDS51210	<b>834</b>
Dispensador vasos de pie	700x600x1600	IDS51209	<b>1484</b>

**GAMA AMPLIADA  
Y RENOVADA**
**PANTALLAS SOPORTE PLANO**

- Para montar **crystal curvo** a 1 o 2 caras o **crystal recto**.
- **Soportes verticales** en tubo redondo  $\varnothing 50\text{mm}$ , o rectangular  $60 \times 40\text{mm}$  **corte recto**, unidos con tubo horizontal o cuerpo de pantalla (según modelo).
- **Anclajes superiores** para sujeción de cristal.
- **Fijación inferior** mediante pletina con embellecedor.

**SOPORTES TUBO REDONDO DIÁMETRO 50MM**

DIM (mm)	NEUTRO	PVP(€)	LUZ	CONSUMO/ TENSIÓN	PVP(€)	LUZ Y CALOR	CONSUMO/ TENSIÓN	PVP(€)
850x100x460 - 2GN1/1	IDB32021	<b>259</b>	IDB32121	10w 230v/50hz	<b>627</b>	IDB32221	460w 230v/50hz	<b>725</b>
1180x100x460 - 3GN1/1	IDB32031	<b>270</b>	IDB32131	14w 230v/50hz	<b>650</b>	IDB32231	690w 230v/50hz	<b>759</b>
1510x100x460 - 4GN1/1	IDB32041	<b>288</b>	IDB32141	18w 230v/50hz	<b>679</b>	IDB32241	920w 230v/50hz	<b>794</b>
1840x100x460 - 5GN1/1	IDB32051	<b>305</b>	IDB32151	22w 230v/50hz	<b>719</b>	IDB32251	1150w 230v/50hz	<b>863</b>
2170x100x460 - 6GN1/1	IDB32061	<b>334</b>	IDB32161	28w 230v/50hz	<b>811</b>	IDB32261	1380w 230v/50hz	<b>932</b>

**SOPORTES TUBO RECTANGULAR 60X40MM**

DIM (mm)	NEUTRO	PVP(€)	LUZ	CONSUMO/ TENSIÓN	PVP(€)	LUZ Y CALOR	CONSUMO/ TENSIÓN	PVP(€)
850x40x460 - 2GN1/1	IDB34421	<b>259</b>	IDB34621	10w 230v/50hz	<b>627</b>	IDB34721	460w 230v/50hz	<b>725</b>
1180x40x460 - 3GN1/1	IDB34431	<b>270</b>	IDB34631	14w 230v/50hz	<b>650</b>	IDB34731	690w 230v/50hz	<b>759</b>
1510x40x460 - 4GN1/1	IDB34441	<b>288</b>	IDB34641	18w 230v/50hz	<b>679</b>	IDB34741	920w 230v/50hz	<b>794</b>
1840x40x460 - 5GN1/1	IDB34451	<b>305</b>	IDB34651	22w 230v/50hz	<b>719</b>	IDB34751	1150w 230v/50hz	<b>863</b>
2170x40x460 - 6GN1/1	IDB34461	<b>334</b>	IDB34661	28w 230v/50hz	<b>811</b>	IDB34761	1380w 230v/50hz	<b>932</b>

**CRISTALES SUPERIORES  
TEMPLADOS CURVOS**

- **Cristales curvos** 6mm para soportes planos.
- **Fijación** mediante tornillos con junta de goma.

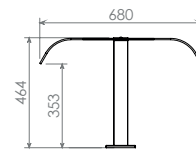
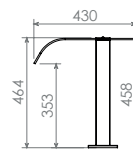
**CURVO 1 CARA**

DIM (mm)	REF	PVP(€)
850x430 - 2GN1/1	IDV32521	<b>253</b>
1180x430 - 3GN1/1	IDV32531	<b>270</b>
1510x430 - 4GN1/1	IDV32541	<b>288</b>
1840x430 - 5GN1/1	IDV32551	<b>305</b>
2170x430 - 6GN1/1	IDV32561	<b>334</b>

**CURVO 2 CARAS**

DIM (mm)	REF	PVP(€)
850x680 - 2GN1/1	IDV32621	<b>293</b>
1180x680 - 3GN1/1	IDV32631	<b>322</b>
1510x680 - 4GN1/1	IDV32641	<b>362</b>
1840x680 - 5GN1/1	IDV32651	<b>403</b>
2170x680 - 6GN1/1	IDV32661	<b>495</b>

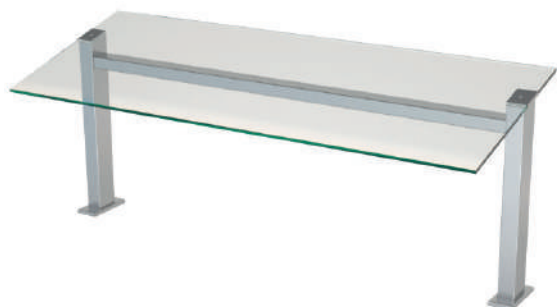
**GAMA AMPLIADA  
Y RENOVADA**
**PANTALLAS SOPORTE INCLINADO**

- Para montar **crystal recto**.
- **Soportes verticales** en tubo redondo  $\varnothing 50\text{mm}$ , o rectangular  $60 \times 40\text{mm}$  **corte inclinado** unidos con tubo horizontal o cuerpo de pantalla (según modelo).
- **Anclajes superiores** para sujeción de cristal.
- **Fijación inferior** mediante pletina con embellecedor.

**SOPORTES TUBO REDONDO DIÁMETRO 50MM**

DIM (mm)	NEUTRO	PVP(€)	LUZ	CONSUMO/ TENSIÓN	PVP(€)	LUZ Y CALOR	CONSUMO/ TENSIÓN	PVP(€)
850x100x460 - 2GN1/1	IDB32321	<b>259</b>	IDB32421	10w 230v/50hz	<b>627</b>	IDB32721	460w 230v/50hz	<b>725</b>
1180x100x460 - 3GN1/1	IDB32331	<b>270</b>	IDB32431	14w 230v/50hz	<b>650</b>	IDB32731	690w 230v/50hz	<b>759</b>
1510x100x460 - 4GN1/1	IDB32341	<b>288</b>	IDB32441	18w 230v/50hz	<b>679</b>	IDB32741	920w 230v/50hz	<b>794</b>
1840x100x460 - 5GN1/1	IDB32351	<b>305</b>	IDB32451	22w 230v/50hz	<b>719</b>	IDB32751	1150w 230v/50hz	<b>863</b>
2170x100x460 - 6GN1/1	IDB32361	<b>334</b>	IDB32461	28w 230v/50hz	<b>811</b>	IDB32761	1380w 230v/50hz	<b>932</b>

**SOPORTES TUBO RECTANGULAR 60X40MM**

DIM (mm)	NEUTRO	PVP(€)	LUZ	CONSUMO/ TENSIÓN	PVP(€)	LUZ Y CALOR	CONSUMO/ TENSIÓN	PVP(€)
850x40x460 - 2GN1/1	IDB34021	<b>259</b>	IDB34121	10w 230v/50hz	<b>627</b>	IDB34221	460w 230v/50hz	<b>725</b>
1180x40x460 - 3GN1/1	IDB34031	<b>270</b>	IDB34131	14w 230v/50hz	<b>650</b>	IDB34231	690w 230v/50hz	<b>759</b>
1510x40x460 - 4GN1/1	IDB34041	<b>288</b>	IDB34141	18w 230v/50hz	<b>679</b>	IDB34241	920w 230v/50hz	<b>794</b>
1840x40x460 - 5GN1/1	IDB34051	<b>305</b>	IDB34151	22w 230v/50hz	<b>719</b>	IDB34251	1150w 230v/50hz	<b>863</b>
2170x40x460 - 6GN1/1	IDB34061	<b>334</b>	IDB34161	28w 230v/50hz	<b>811</b>	IDB34261	1380w 230v/50hz	<b>932</b>

**CRISTALES  
TEMPLADOS RECTOS**

- **Crystales superiores** 8mm, para soportes planos o inclinados.
- **Crystales frontales** 8mm para **todo tipo** de pantallas.
- **Fijación** mediante tornillos con junta de goma.

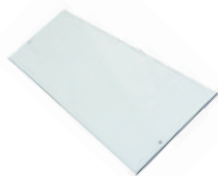
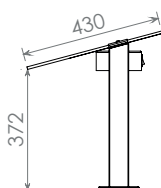
**SUPERIOR**

DIM (mm)	REF	PVP(€)
850x430 - 2GN1/1	IDV34521	<b>145</b>
1180x430 - 3GN1/1	IDV34531	<b>167</b>
1510x430 - 4GN1/1	IDV34541	<b>196</b>
1840x430 - 5GN1/1	IDV34551	<b>236</b>
2170x430 - 6GN1/1	IDV34561	<b>288</b>

**FRONTAL**

ANCHO (mm)	PANTALLA PLANA ALTO 420	PVP(€)	PANTALLA INCLINADA ALTO 340	PVP(€)
850 - 2GN1/1	IDV79621	<b>131</b>	IDV79521	<b>121</b>
1180 - 3GN1/1	IDV79631	<b>149</b>	IDV79531	<b>138</b>
1510 - 4GN1/1	IDV79641	<b>180</b>	IDV79541	<b>167</b>
1840 - 5GN1/1	IDV79651	<b>224</b>	IDV79551	<b>207</b>
2170 - 6GN1/1	IDV79661	<b>255</b>	IDV79561	<b>236</b>





## DESLIZADORES BANDEJAS MUEBLES AUTOSERVICIO

- 3 **tubos** horizontales de  $\varnothing 25$ mm, soldados a cartelas de sujeción a mueble.

Montaje a mueble sin herramientas.

DIM (mm)	REF	PVP(€)
400x330	IDS81004	155
600x330	IDS81005	176
800x330	IDS81008	184
900x330	IDS81009	230
1200x330 - 3GN1/1	IDS81012	276
1600x330 - 4GN1/1	IDS81016	374
1615x330 mueble angular	IDS81011	500
2000x330 - 5GN1/1	IDS81020	472
2200x330 - 6GN1/1	IDS81022	518

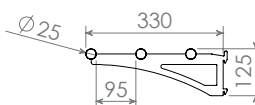









## DECORACIÓN FRONTAL MUEBLES AUTOSERVICIO

- Preparados para colocarse en parte frontal de muebles autoservicio, gran variedad de colores sólidos y maderas.

\* Para otros colores o materiales consultar.

### DECORACIÓN COLORES SÓLIDOS

	<b>RAL 1001</b> Beige Pantone 728		<b>RAL 4005</b> Lila Pantone 667
	<b>RAL 1023</b> Amarillo Pantone 1235		<b>RAL 5002</b> Azul Pantone 288
	<b>RAL 2004</b> Naranja Pantone 1655		<b>RAL 6018</b> Verde Pantone 363
	<b>RAL 3020</b> Rojo Pantone 485		<b>RAL 9010</b> Blanco puro Cool Grey 1

DIM (mm)	REF	PVP(€)
400x19x680	IDS90004	115
600x19x680	IDS90005	127
800x19x690	IDS90008	144
900x19x690 - 2GN1/1	IDS90009	175
1200x19x680 - 3GN1/1	IDS90012	242
1600x19x680 - 4GN1/1	IDS90016	328
1615x19x680 mueble angular	IDS90011	173
2000x19x680 - 5GN1/1	IDS90020	426
2200x19x680 - 6GN1/1	IDS90022	466

### DECORACIÓN MADERA

	Pino
	Roble
	Nogal
	Wengé

DIM (mm)	REF	PVP(€)
400x19x680	IDS91004	155
600x19x680	IDS91005	167
800x19x690	IDS91008	184
900x19x690 - 2GN1/1	IDS91009	205
1200x19x680 - 3GN1/1	IDS91012	276
1600x19x680 - 4GN1/1	IDS91016	374
1615x19x680 mueble angular	IDS91011	213
2000x19x680 - 5GN1/1	IDS91020	472
2200x19x680 - 6GN1/1	IDS91022	518

# 13.



## CAJONES INDIVIDUALES PARA MUEBLES O MÓDULOS

- Cajones con **guías telescópicas**.



**Montaje rápido y fácil**  
Se suministran desmontados.

DIM (mm)	REF	PVP(€)
400x450x220	IDH04540	<b>242</b>
500x450x220	IDH04550	<b>259</b>



## ADAPTACIÓN CERRADURA

- Adaptadas a las puertas y cajones de la gama estándar.

\* Precio por unidad.

CARACTERÍSTICAS	REF	PVP(€)
Adaptación cerradura con llave	IDH04580	<b>86</b>



## ZÓCALO PARA MUEBLES AUTOSERVICIO

\*Se suministra desmontado. Fácil montaje sin herramientas en la parte inferior del mueble.

\* Precio metro lineal.

CARACTERÍSTICAS	REF	PVP(€)
Zócalo inferior	EID90400	<b>81</b>

## ADAPTACIÓN DE RUEDAS

- Se suministran **totalmente montadas** en la base de los muebles armarios.

- **Posición ruedas** con freno o sin freno a elección del cliente, izquierda, derecha o frente.



### RUEDAS SINTÉTICAS

CARACTERÍSTICAS	REF	PVP(€)
4 Ruedas 125ø (2 con freno)	IDH90415	<b>276</b>
6 Ruedas 125ø (3 con freno)	IDH90425	<b>374</b>



### RUEDAS ACERO INOXIDABLE

CARACTERÍSTICAS	REF	PVP(€)
4 Ruedas 125ø (2 con freno)	IDH90435	<b>328</b>
6 Ruedas 125ø (3 con freno)	IDH90445	<b>420</b>

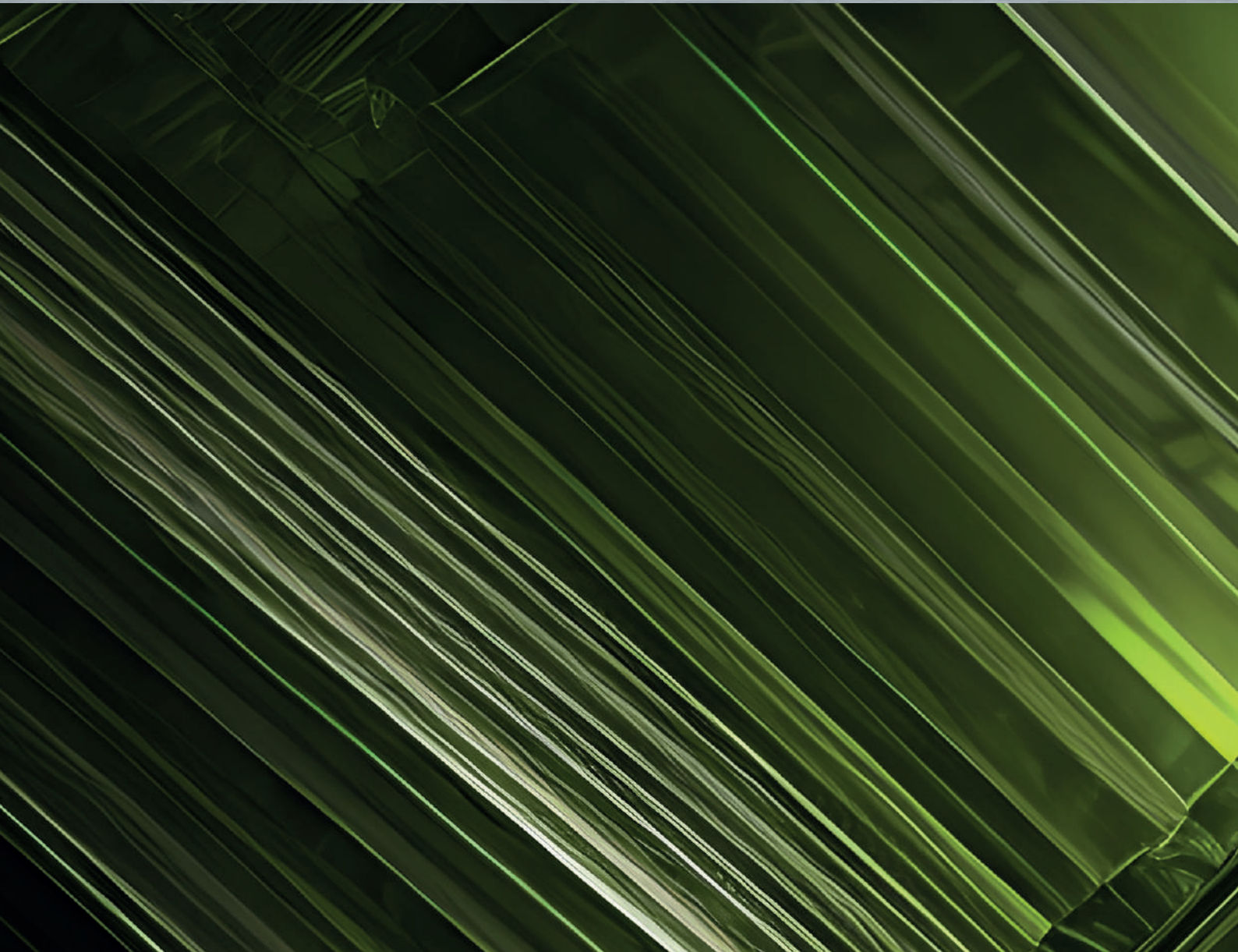



# 14.

- Placas frías
- Cubas frías
- Cubas ventiladas
- Cubas helados
- Accesorios
- Vitrinas frías
- Placas calientes vitrocerámica
- Cubas baño maría
- Petacas calefactadas
- Dispensador platos
- Pantallas y cristales

## PLACAS BUFFET FRÍAS

- Placa con **perfil vierteaguas** perimetral.
- **Refrigeradas** mediante serpentín oculto, aisladas con poliestileno expandido.
- **Desagüe** inferior.
- Elementos para **encastrar** en encimera.

\* Las unidades condensadoras recomendadas no están incluidas en el precio.

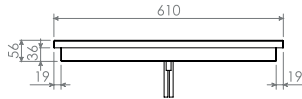

DIM (mm)	DIM. ENCASTRE (mm)	POTENCIA RECOMENDADA	REF	PVP(€)
410x610x60 - 1GN1/1	380x580	1/4cv	IDB09711	989
730x610x60 - 2GN1/1	700x580	1/4cv	IDB09721	1064
1060x610x60 - 3GN1/1	1030x580	1/4cv	IDB09731	1116
1390x610x60 - 4GN1/1	1360x580	1/4cv	IDB09741	1225
1720x610x60 - 5GN1/1	1690x580	1/4cv	IDB09751	1415
2030x610x60 - 6GN1/1	2000x580	3/8cv	IDB09761	1622

## PLACAS BUFFET FRÍAS GRUPO INCORPORADO

- Placa con **perfil vierteaguas** perimetral.
- **Refrigeradas** mediante serpentín oculto, aisladas con poliestileno expandido.
- **Desagüe** inferior.
- **Unidad condensadora** incorporada en parte inferior, con cuadro de mandos móvil (máx.1m) y **termostato** digital. Temperatura de trabajo 0°C / 4°C.
- Elementos para **encastrar** en encimera.



Refrigerante R290.

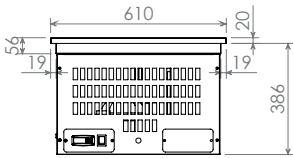

DIM (mm)	DIM. ENCASTRE (mm)	POTENCIA	CONSUMO/TENSIÓN	REF	PVP(€)
410x610x440 - 1GN1/1	380x580	1/4cv	235w 230v/50hz	IDB19711	1472
730x610x440 - 2GN1/1	700x580	1/4cv	235w 230v/50hz	IDB19721	1558
1060x610x440 - 3GN1/1	1030x580	1/4cv	235w 230v/50hz	IDB19731	1627
1390x610x440 - 4GN1/1	1360x580	1/4cv	327w 230v/50hz	IDB19741	1737
1720x610x440 - 5GN1/1	1690x580	1/4cv	327w 230v/50hz	IDB19751	1961
2030x610x440 - 6GN1/1	2000x580	3/8cv	473w 230v/50hz	IDB19761	2174



## PLACAS BUFFET FRÍAS DOBLE NIVEL

- Doble nivel de placa con perfil **vierteaguas perimetral**.
- **Refrigeradas** mediante serpentín oculto, aisladas con poliestileno expandido.
- **Desagüe** inferior.
- Elementos para **encastrar** en encimera.

\* Las unidades condensadoras recomendadas no están incluidas en el precio.

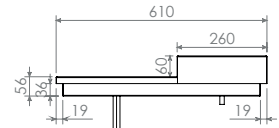

DIM (mm)	DIM. ENCASTRE (mm)	POTENCIA RECOMENDADA	REF	PVP(€)
410x610x140 - 1GN1/1	380x580	1/4cv	IDB09811	<b>1288</b>
730x610x140 - 2GN1/1	700x580	1/4cv	IDB09821	<b>1363</b>
1060x610x140 - 3GN1/1	1030x580	1/4cv	IDB09831	<b>1415</b>
1390x610x140 - 4GN1/1	1360x580	1/4cv	IDB09841	<b>1524</b>
1720x610x140 - 5GN1/1	1690x580	1/4cv	IDB09851	<b>1714</b>
2030x610x140 - 6GN1/1	2000x580	3/8cv	IDB09861	<b>1921</b>

## PLACAS BUFFET FRÍAS DOBLE NIVEL GRUPO INCORPORADO

Refrigerante R290.



- Doble nivel de placa con **perfil vierteaguas** perimetral.
- **Refrigeradas** mediante serpentín oculto, aisladas con poliestileno expandido.
- **Desagüe** inferior.
- **Unidad condensadora** incorporada en parte inferior, con cuadro de mandos móvil (máx.1m) y **termostato** digital. Temperatura de trabajo 0°C / 4°C.
- Elementos para **encastrar** en encimera.

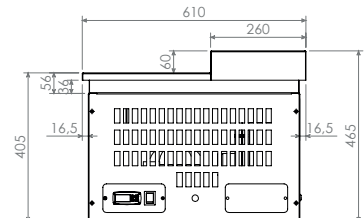

DIM (mm)	DIM. ENCASTRE (mm)	POTENCIA	CONSUMO/TENSIÓN	REF	PVP(€)
410x610x520 - 1GN1/1	380x580	1/4cv	235w 230v/50hz	IDB19811	<b>1771</b>
730x610x520 - 2GN1/1	700x580	1/4cv	235w 230v/50hz	IDB19821	<b>1857</b>
1060x610x520 - 3GN1/1	1030x580	1/4cv	235w 230v/50hz	IDB19831	<b>1926</b>
1390x610x520 - 4GN1/1	1360x580	1/4cv	327w 230v/50hz	IDB19841	<b>2036</b>
1720x610x520 - 5GN1/1	1690x580	1/4cv	327w 230v/50hz	IDB19851	<b>2260</b>
2030x610x520 - 6GN1/1	2000x580	3/8cv	473w 230v/50hz	IDB19861	<b>2473</b>

## CUBAS BUFFET FRÍAS

- **Cuba** con radios sanitarios para cubetas de 150mm de profundidad.
- **Refrigeradas** mediante serpentín oculto, aisladas con poliestileno expandido.
- **Desagüe** inferior.
- Elementos para **encastrar** en encimera.

\* Las unidades condensadoras recomendadas no están incluidas en el precio.

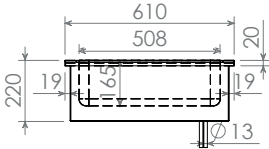

DIM (mm)	DIM. ENCASTRE (mm)	POTENCIA RECOMENDADA	REF	PVP(€)
410x610x220 - 1GN1/1	380x580	1/4cv	IDB09611	1139
730x610x220 - 2GN1/1	700x580	1/4cv	IDB09621	1242
1060x610x220 - 3GN1/1	1030x580	1/4cv	IDB09631	1300
1390x610x220 - 4GN1/1	1360x580	1/4cv	IDB09641	1409
1720x610x220 - 5GN1/1	1690x580	1/4cv	IDB09651	1725
2030x610x220 - 6GN1/1	2000x580	3/8cv	IDB09661	1949

## CUBAS BUFFET FRÍAS GRUPO INCORPORADO

- **Cuba** con radios sanitarios para cubetas de 150mm de profundidad.
- **Refrigeradas** mediante serpentín oculto, aisladas con poliestileno expandido.
- **Desagüe** inferior.
- **Unidad condensadora** incorporada en parte inferior, con cuadro de mandos móvil (máx.1m) y **termostato** digital. Temperatura de trabajo 0°C / 4°C.
- Elementos para **encastrar** en encimera.

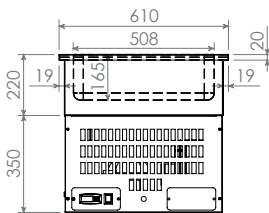

Refrigerante R290.



DIM (mm)	DIM. ENCASTRE (mm)	POTENCIA	CONSUMO/TENSIÓN	REF	PVP(€)
410x610x570 - 1GN1/1	380x580	1/4cv	235w 230v/50hz	IDB19611	1541
730x610x570 - 2GN1/1	700x580	1/4cv	235w 230v/50hz	IDB19621	1645
1060x610x570 - 3GN1/1	1030x580	1/4cv	235w 230v/50hz	IDB19631	1737
1390x610x570 - 4GN1/1	1360x580	1/4cv	327w 230v/50hz	IDB19641	1944
1720x610x570 - 5GN1/1	1690x580	1/4cv	327w 230v/50hz	IDB19651	2202
2030x610x570 - 6GN1/1	2000x580	3/8cv	473w 230v/50hz	IDB19661	2524

## CUBAS BUFFET VENTILADAS

- **Cuba** con radios rectos para cubetas de 150mm de profundidad, piso inferior regulable y desmontable.
- **Refrigeradas** mediante evaporador tiro forzado en parte inferior, aisladas con poliestileno expandido.
- **Desagüe** inferior en cuba.
- Elementos para **encastrar** en encimera.

\* Las unidades condensadoras recomendadas no están incluidas en el precio.

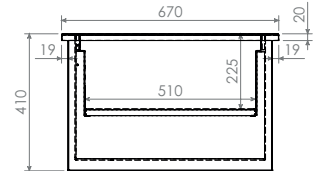

DIM (mm)	DIM. ENCASTRE (mm)	POTENCIA RECOMENDADA	REF	PVP(€)
730x670x410 - 2GN1/1	700x640	1/4cv	IDB29621	1799
1060x670x410 - 3GN1/1	1030x640	3/8cv	IDB29631	1990
1390x670x410 - 4GN1/1	1360x640	3/8cv	IDB29641	2310
1720x670x410 - 5GN1/1	1690x640	3/8cv	IDB29651	2570
2030x670x410 - 6GN1/1	2000x640	1/2cv	IDB29661	2956

## CUBAS BUFFET VENTILADAS GRUPO INCORPORADO

Refrigerante R290.



- **Cuba** con radios rectos para cubetas de 150mm de profundidad, piso inferior regulable y desmontable.
- **Refrigeradas** mediante evaporador tiro forzado en parte inferior, aisladas con poliestileno expandido.
- **Desagüe** inferior.
- **Unidad condensadora** incorporada en parte inferior, con cuadro de mandos móvil (máx.1m) y **termostato** digital. Temperatura de trabajo 0°C / 4°C.
- Elementos para **encastrar** en encimera.

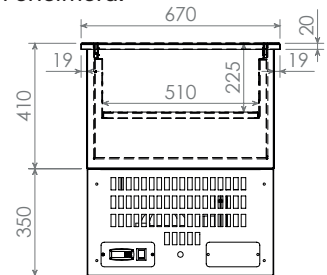

DIM (mm)	DIM. ENCASTRE (mm)	POTENCIA	CONSUMO/TENSIÓN	REF	PVP(€)
730x670x760 - 2GN1/1	700x640	1/4cv	327w 230v/50hz	IDB39621	2248
1060x670x760 - 3GN1/1	1030x640	3/8cv	473w 230v/50hz	IDB39631	2427
1390x670x760 - 4GN1/1	1360x640	3/8cv	473w 230v/50hz	IDB39641	2750
1720x670x760 - 5GN1/1	1690x640	3/8cv	473w 230v/50hz	IDB39651	2989
2030x670x760 - 6GN1/1	2000x640	1/2cv	692w 230v/50hz	IDB39661	3321

## CUBAS BUFFET HELADOS

- **Cuba** con radios rectos para cubetas de 150mm de profundidad.
- **Refrigeradas** mediante serpentín oculto, aisladas con poliestileno expandido.
- **Desagüe** inferior en cuba.
- Elementos para **encastrar** en encimera.

\* Las unidades condensadoras recomendadas no están incluidas en el precio.

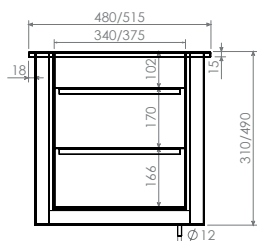

DIM (mm)	NIVELES	DIM. ENCASTRE (mm)	POTENCIA RECOMENDADA	REF	PVP(€)
860x480x490 - 4+4 GN 1/3	2	830x450	1/2cv	IDB09944	1231
815x515x490 - 4+4 c.Helado	2	785x485	1/2cv	IDB09945	1190
860x480x310 - 4GN 1/3	1	830x450	1/3cv	IDB09946	1047
815x515x310 - 4 c.Helado	1	785x485	1/3cv	IDB09947	1012

## CUBAS BUFFET HELADOS GRUPO INCORPORADO

- **Cuba** con radios rectos para cubetas de 150mm de profundidad.
- **Refrigeradas** mediante serpentín oculto, aisladas con poliestileno expandido.
- **Desagüe** inferior en cuba.
- **Unidad condensadora** incorporada en parte inferior, con cuadro de mandos móvil (máx.1m) y **termostato** digital. Temperatura de trabajo -18°C / -20°C.
- Elementos para **encastrar** en encimera.

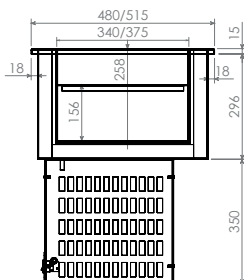

Refrigerante R290.



DIM (mm)	NIVELES	DIM. ENCASTRE (mm)	POTENCIA	CONSUMO/ TENSIÓN	REF	PVP(€)
860x480x660 - 4GN 1/3	1	830x450	1/3cv	660w 230v/50hz	IDB09950	1576
815x515x660 - 4 c.Helado	1	785x485	1/3cv	660w 230v/50hz	IDB09951	1541

# 14.

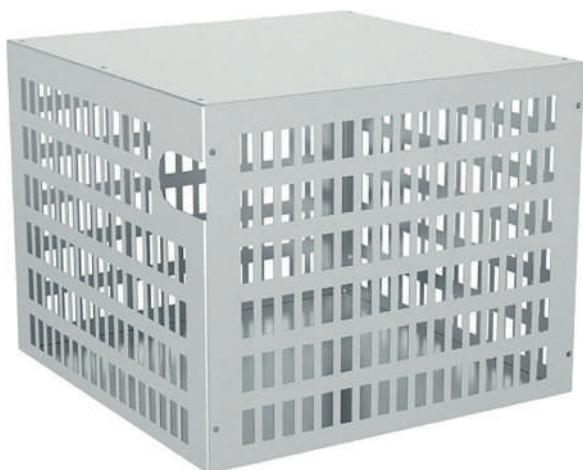

## LAVAPORCIONADORES ENCASTRABLES

- **Cuba** con cantos sanitarios.
- Separador interno desmontable, accesorios para carga y descarga de agua incluidos.

### LAVAPORCIONADOR SIMPLE

DIM (mm)	DIM. ENCASTRE (mm)	REF	PVP(€)
270x120x110	254x104	IDB20001	115

### LAVAPORCIONADOR GRIFO BOLA+SIFÓN

DIM (mm)	DIM. ENCASTRE (mm)	REF	PVP(€)
270x120x310	254x104	IDB20002	190

## CARCASA TERMOSTATO PARA ACOUPLE A PANTALLAS

- Preparadas para fijación a pantallas buffet.

\* Termostato no incluido

DIM (mm)	DIM. ENCASTRE TERMOSTATO (mm)	REF	PVP(€)
120x100x40	74x30	IDB20003	81

## CAJA VENTILADA PARA UNIDAD CONDENSADORA

- Totalmente perforada para una correcta ventilación, laterales y techo desmontables.
- Preparada para incorporar y proteger unidades condensadoras de cubas y placas frías con motor remoto.

DIM (mm)	REF	PVP(€)
565x360x350	IDB05050	420



## VITRINAS BUFFET CON CUBA FRÍA VENTILADA

- Laterales y 3 niveles de estante regulable en **crystal**.
- **Iluminación** LED.
- **Cuba** con radios rectos para cubetas de 150mm de profundidad, piso inferior desmontable.
- Cuba y vitrina **refrigeradas** mediante evaporador tiro forzado en parte inferior, **aisladas** con poliestireno expandido y **cortina** nocturna enrollable.
- **Unidad condensadora** incorporada en parte inferior, cuadro de mandos móvil (máx. 1m) y **termostato** digital. Temperatura de trabajo 0°C / 4°C en cuba fría, 8°C / 10°C en vitrina.
- Elementos para **encastrarse** en encimera, medidas GN.

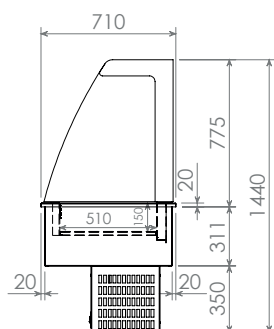

Refrigerante R290.



### TRASERA CERRADA

DIM (mm)	DIM ENCASTRE (mm)	POTENCIA	CONSUMO/TENSIÓN	REF	PVP(€)
1060x710x775/1440 - 3GN1/1	1030x680	1/2cv	692w 230v/50hz	IDB29131	<b>5249</b>
1390x710x775/1440 - 4GN1/1	1360x680	1/2cv	692w 230v/50hz	IDB29141	<b>5522</b>

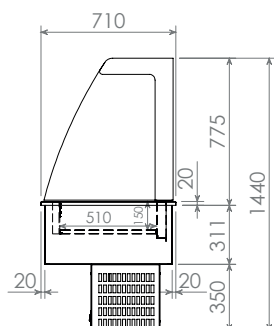

### TRASERA CON PUERTAS BATIENTES

DIM (mm)	DIM ENCASTRE (mm)	POTENCIA	CONSUMO/TENSIÓN	REF	PVP(€)
1060x710x775/1440 - 3GN1/1	1030x680	1/2cv	692w 230v/50hz	IDB29231	<b>5832</b>
1390x710x775/1440 - 4GN1/1	1360x680	1/2cv	692w 230v/50hz	IDB29241	<b>6135</b>

NOVEDAD

## VITRINAS BUFFET CON PLACA FRÍA VENTILADA Y PUERTAS BATIENTES TRASERAS



Refrigerante R290.

- Frontal opcional, laterales y 3 niveles de estante regulable en **crystal**.
- **Iluminación** LED.
- **Refrigeradas** mediante evaporador tiro forzado en parte inferior, **aisladas** con poliestireno expandido.
- Opción **crystal** frontal o **cortina** nocturna enrollable.
- **Unidad condensadora** incorporada en parte inferior, cuadro de mandos móvil (máx. 1m) y **termostato** digital. Temperatura de trabajo 0°C / 4°C en placa fría, 8°C / 10°C en vitrina.
- Elementos para **encastrarse** en encimera, medidas GN.

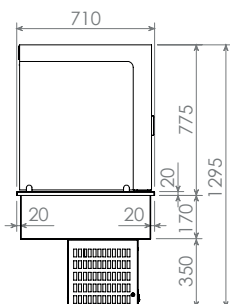
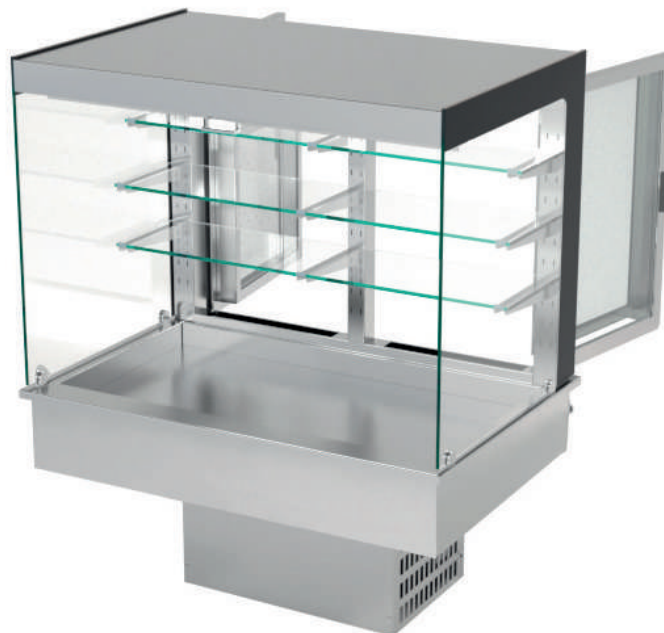

### FRONTAL ABIERTO

DIM (mm)	DIM ENCASTRE (mm)	POTENCIA	CONSUMO/TENSIÓN	REF	PVP(€)
1060x710x775/1300 - 3GN1/1	1030x680	1/2cv	692w 230v/50hz	IDB29331	<b>6012</b>
1390x710x775/1300 - 4GN1/1	1360x680	1/2cv	692w 230v/50hz	IDB29341	<b>6325</b>

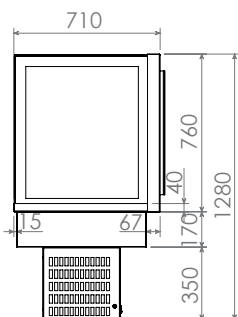

### FRONTAL CERRADO

DIM (mm)	DIM ENCASTRE (mm)	POTENCIA	CONSUMO/TENSIÓN	REF	PVP(€)
1060x710x760/1280 - 3GN1/1	1030x640	3/8cv	473w 230v/50hz	IDB29431	<b>6262</b>
1390x710x760/1280 - 4GN1/1	1360x640	3/8cv	473w 230v/50hz	IDB29441	<b>6588</b>

GAMA AMPLIADA  
Y RENOVADA

## PLACAS BUFFET CALIENTES VITOCERÁMICA

- **Cristal** superior templado color negro o blanco.
- **Aisladas** con lana de roca.
- **Resistencias** ocultas.
- **Interruptor** ON/OFF luminoso y **termostato** digital 0° / 130°C.
- Elementos para **encastrar** en encimera.

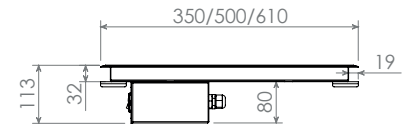

### MARCO PERIMETRAL ACERO INOXIDABLE

#### MEDIDAS GN

DIM (mm)	DIM. ENCASTRE (mm)	CONSUMO/TENSIÓN	CRISTAL NEGRO	CRISTAL BLANCO	PVP(€)
410x610x100 - 1GN1/1	380x580	450w 230v/50-60hz	IDB09511	IDB19511	1363
730x610x100 - 2GN1/1	700x580	900w 230v/50-60hz	IDB09521	IDB19521	1507
1060x610x100 - 3GN1/1	1030x580	1350w 230v/50-60hz	IDB09531	IDB19531	1754
1390x610x100 - 4GN1/1	1360x580	1800w 230v/50-60hz	IDB09541	IDB19541	2041
1720x610x100 - 5GN1/1	1690x580	2250w 230v/50-60hz	IDB09551	IDB19551	2317
2050x610x100 - 6GN1/1	2020x580	2700w 230v/50-60hz	IDB09561	IDB19561	2588

#### ANCHO 500/350

DIM (mm)	DIM. ENCASTRE (mm)	CONSUMO/TENSIÓN	CRISTAL NEGRO	CRISTAL BLANCO	PVP(€)
500x500x100	470x470	800w 230v/50-60hz	IDB09211	IDB19211	1093
730x350x100	700x320	800w 230v/50-60hz	IDB09221	IDB19221	1208
1060x350x100	1030x320	1200w 230v/50-60hz	IDB09231	IDB19231	1415
1390x350x100	1360x320	1600w 230v/50-60hz	IDB09241	IDB19241	1645
1720x350x100	1690x320	2000w 230v/50-60hz	IDB09251	IDB19251	1863
2050x350x100	2020x320	2400w 230v/50-60hz	IDB09261	IDB19261	2070



### SIN MARCO PERIMETRAL ACERO INOX

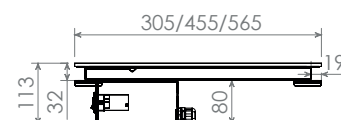

#### MEDIDAS GN

DIM (mm)	DIM. ENCASTRE (mm)	CONSUMO/TENSIÓN	CRISTAL NEGRO	CRISTAL BLANCO	PVP(€)
355x565x100 - 1GN1/1	325x535	450w 230v/50-60hz	IDB09111	IDB19111	<b>1225</b>
685x565x100 - 2GN1/1	655x535	900w 230v/50-60hz	IDB09121	IDB19121	<b>1219</b>
1015x565x100 - 3GN1/1	985x535	1350w 230v/50-60hz	IDB09131	IDB19131	<b>1420</b>
1345x565x100 - 4GN1/1	1315x535	1800w 230v/50-60hz	IDB09141	IDB19141	<b>1650</b>
1675x565x100 - 5GN1/1	1645x535	2250w 230v/50-60hz	IDB09151	IDB19151	<b>1880</b>
2005x565x100 - 6GN1/1	1975x535	2700w 230v/50-60hz	IDB09161	IDB19161	<b>2099</b>

#### ANCHO 455/305

DIM (mm)	DIM. ENCASTRE (mm)	CONSUMO/TENSIÓN	CRISTAL NEGRO	CRISTAL BLANCO	PVP(€)
455x455x100	425x425	800w 230v/50-60hz	IDB09011	IDB19011	<b>1131</b>
685x305x100	655x275	800w 230v/50-60hz	IDB09021	IDB19021	<b>1250</b>
1015x305x100	985x275	1200w 230v/50-60hz	IDB09031	IDB19031	<b>1461</b>
1345x305x100	1315x275	1600w 230v/50-60hz	IDB09041	IDB19041	<b>1706</b>
1675x305x100	1645x275	2000w 230v/50-60hz	IDB09051	IDB19051	<b>1931</b>
2005x305x100	1975x275	2400w 230v/50-60hz	IDB09061	IDB19061	<b>2142</b>

## CUBAS BUFFET BAÑO MARÍA HÚMEDO

- **Cuba** con radios sanitarios para cubetas de 150mm de profundidad.
- **Aisladas** con lana de roca.
- **Resistencias** ocultas.
- **Interruptor** ON/OFF luminoso y **termostato** digital 0°C / 90°C.
- **Desagüe** con grifo bola.
- Elementos para **encastrar** en encimera.

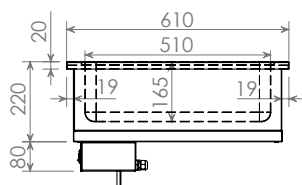

DIM (mm)	DIM. ENCASTRE (mm)	CONSUMO/TENSIÓN	REF	PVP(€)
410x610x100 - 1GN1/1	380x580	800w 230v/50-60hz	IDB09311	1127
730x610x220 - 2GN1/1	700x580	1600w 230v/50-60hz	IDB09321	1300
1060x610x220 - 3GN1/1	1030x580	2000w 230v/50-60hz	IDB09331	1507
1390x610x220 - 4GN1/1	1360x580	3000w 230v/50-60hz	IDB09341	1719
1720x610x220 - 5GN1/1	1690x580	3600w 230v/50-60hz	IDB09351	2087
2030x610x220 - 6GN1/1	2000x580	3600w 230v/50-60hz	IDB09361	2461

## CUBAS BUFFET BAÑO MARÍA SECO

- **Cuba** cantos sanitarios para cubetas de 150mm de profundidad.
- **Aisladas** con lana de roca.
- **Resistencias** blindadas, protegidas mediante chapa fondo perforado.
- **Interruptor** ON/OFF luminoso y **termostato** digital 0°C / 90°C.
- Elementos para **encastrar** en encimera.

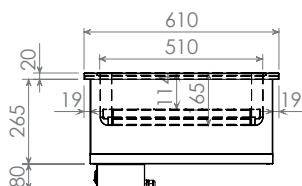

DIM (mm)	DIM. ENCASTRE (mm)	CONSUMO/TENSIÓN	REF	PVP(€)
410x610x285 - 1GN1/1	380x580	400w 230v/50-60hz	IDB09411	983
730x610x285 - 2GN1/1	700x580	800w 230v/50-60hz	IDB09421	1047
1060x610x285 - 3GN1/1	1030x580	1200w 230v/50-60hz	IDB09431	1127
1390x610x285 - 4GN1/1	1360x580	1600w 230v/50-60hz	IDB09441	1334
1720x610x285 - 5GN1/1	1690x580	2000w 230v/50-60hz	IDB09451	1668
2030x610x285 - 6GN1/1	2000x580	2400w 230v/50-60hz	IDB09461	2030



## PETACAS CALEFACTADAS PARA ENCASTRE

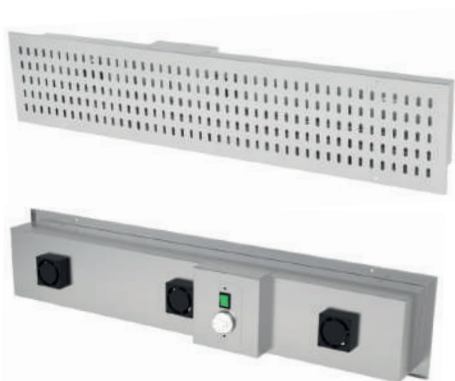

- **Aisladas** con lana de roca.
- **Resistencias** maleables protegidas mediante chapa perforada.
- Impulsión de aire caliente mediante **ventiladores** traseros.
- **Interruptor** ON/OFF luminoso y **termostato** analógico 0°C / 60°C.
- Elementos para **encastrar** boca de platos frontal.

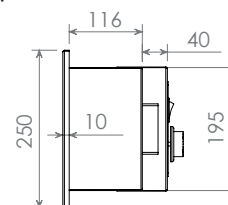

DIM (mm)	DIM. ENCASTRE (mm)	CONSUMO/TENSIÓN	REF	PVP(€)
800x125x250	750x200x200	600w 230v/50-60hz	IDB21108	437
1200x125x250	1150x200x200	800w 230v/50-60hz	IDB21112	518
1500x125x250	1450x200x200	1000w 230v/50-60hz	IDB21115	650
1800x125x250	1750x200x200	1100w 230v/50-60hz	IDB21118	794
2000x125x250	1950x200x200	1100w 230v/50-60hz	IDB21120	886



## DISPENSADOR DE PLATOS A NIVEL CONSTANTE

- Sistema de muelles para **regulación** altura de platos.
- **Capacidad** aproximada para 60 platos por poza, diámetro regulable para platos de  $\varnothing 180$  a  $\varnothing 260$  y de  $\varnothing 240$  a  $\varnothing 320$ mm (según modelo).
- Modelos calientes **calefactados** con resistencias, **termostato** analógico 0°C / 90°C.
- Elementos para **encastrar** en encimera.

DIM (mm)	DIM. ENCASTRE (mm)	CONSUMO/TENSIÓN	REF	PVP(€)
380 $\varnothing$ x660 - Platos 180/260 $\varnothing$	340 $\varnothing$	-	IDB20101	408
440 $\varnothing$ x660 - Platos 240/320 $\varnothing$	395 $\varnothing$	-	IDB20102	443
380 $\varnothing$ x660 - Platos 180/260 $\varnothing$	340 $\varnothing$	500w 230v/50-60hz	IDB20201	817
440 $\varnothing$ x660 - Platos 240/320 $\varnothing$	395 $\varnothing$	500w 230v/50-60hz	IDB20202	863

**GAMA AMPLIADA  
Y RENOVADA**
**PANTALLAS SOPORTE PLANO**

- Para montar **crystal curvo** a 1 o 2 caras o **crystal recto**.
- **Soportes verticales** en tubo redondo  $\varnothing 50\text{mm}$ , o rectangular  $60 \times 40\text{mm}$  **corte recto**, unidos con tubo horizontal o cuerpo de pantalla (según modelo).
- **Anclajes superiores** para sujeción de cristal.
- **Fijación inferior** mediante pletina con embellecedor.

**SOPORTES TUBO REDONDO DIÁMETRO 50MM**

DIM (mm)	NEUTRO	PVP(€)	LUZ	CONSUMO/ TENSIÓN	PVP(€)	LUZ Y CALOR	CONSUMO/ TENSIÓN	PVP(€)
520x100x460 - 1GN1/1	IDB32011	247	IDB32111	10w 230v/50hz	604	IDB32211	230w 230v/50hz	696
850x100x460 - 2GN1/1	IDB32021	259	IDB32121	10w 230v/50hz	627	IDB32221	460w 230v/50hz	725
1180x100x460 - 3GN1/1	IDB32031	270	IDB32131	14w 230v/50hz	650	IDB32231	690w 230v/50hz	759
1510x100x460 - 4GN1/1	IDB32041	288	IDB32141	18w 230v/50hz	679	IDB32241	920w 230v/50hz	794
1840x100x460 - 5GN1/1	IDB32051	305	IDB32151	22w 230v/50hz	719	IDB32251	1150w 230v/50hz	863
2170x100x460 - 6GN1/1	IDB32061	334	IDB32161	28w 230v/50hz	811	IDB32261	1380w 230v/50hz	932

**SOPORTES TUBO RECTANGULAR 60X40MM**

DIM (mm)	NEUTRO	PVP(€)	LUZ	CONSUMO/ TENSIÓN	PVP(€)	LUZ Y CALOR	CONSUMO/ TENSIÓN	PVP(€)
520x40x460 - 1GN1/1	IDB34411	247	IDB34611	10w 230v/50hz	604	IDB34711	230w 230v/50hz	696
850x40x460 - 2GN1/1	IDB34421	259	IDB34621	10w 230v/50hz	627	IDB34721	460w 230v/50hz	725
1180x40x460 - 3GN1/1	IDB34431	270	IDB34631	14w 230v/50hz	650	IDB34731	690w 230v/50hz	759
1510x40x460 - 4GN1/1	IDB34441	288	IDB34641	18w 230v/50hz	679	IDB34741	920w 230v/50hz	794
1840x40x460 - 5GN1/1	IDB34451	305	IDB34651	22w 230v/50hz	719	IDB34751	1150w 230v/50hz	863
2170x40x460 - 6GN1/1	IDB34461	334	IDB34661	28w 230v/50hz	811	IDB34761	1380w 230v/50hz	932

**CRISTALES SUPERIORES  
TEMPLADOS CURVOS**

- **Crystales curvos** 6mm para soportes rectos.
- **Fijación** mediante tornillos con junta de goma.

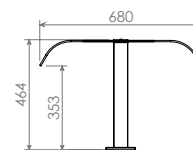
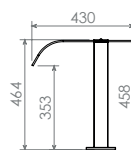
**CURVO 1 CARA**

DIM (mm)	REF	PVP(€)
520x430 - 1GN1/1	IDV32521	242
850x430 - 2GN1/1	IDV32521	253
1180x430 - 3GN1/1	IDV32531	270
1510x430 - 4GN1/1	IDV32541	288
1840x430 - 5GN1/1	IDV32551	305
2170x430 - 6GN1/1	IDV32561	334

**CURVO 2 CARAS**

DIM (mm)	REF	PVP(€)
520x680 - 1GN1/1	IDV32611	259
850x680 - 2GN1/1	IDV32621	293
1180x680 - 3GN1/1	IDV32631	322
1510x680 - 4GN1/1	IDV32641	362
1840x680 - 5GN1/1	IDV32651	403
2170x680 - 6GN1/1	IDV32661	495

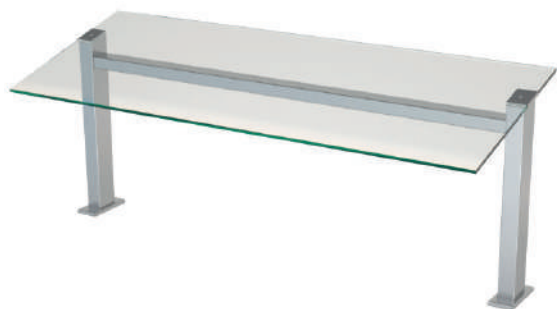
**GAMA AMPLIADA  
Y RENOVADA**
**PANTALLAS SOPORTE INCLINADO**

- Para montar **crystal recto**.
- **Soportes verticales** en tubo redondo  $\varnothing 50\text{mm}$ , o rectangular  $60 \times 40\text{mm}$  **corte inclinado** unidos con tubo horizontal o cuerpo de pantalla (según modelo).
- **Anclajes superiores** para sujeción de cristal.
- **Fijación inferior** mediante pletina con embellecedor.

**SOPORTES TUBO REDONDO DIÁMETRO 50MM**

DIM (mm)	NEUTRO	PVP(€)	LUZ	CONSUMO/ TENSIÓN	PVP(€)	LUZ Y CALOR	CONSUMO/ TENSIÓN	PVP(€)
520x100x460 - 1GN1/1	IDB32311	247	IDB32411	10w 230v/50hz	604	IDB32711	230w 230v/50hz	696
850x100x460 - 2GN1/1	IDB32321	259	IDB32421	10w 230v/50hz	627	IDB32721	460w 230v/50hz	725
1180x100x460 - 3GN1/1	IDB32331	270	IDB32431	14w 230v/50hz	650	IDB32731	690w 230v/50hz	759
1510x100x460 - 4GN1/1	IDB32341	288	IDB32441	18w 230v/50hz	679	IDB32741	920w 230v/50hz	794
1840x100x460 - 5GN1/1	IDB32351	305	IDB32451	22w 230v/50hz	719	IDB32751	1150w 230v/50hz	863
2170x100x460 - 6GN1/1	IDB32361	334	IDB32461	28w 230v/50hz	811	IDB32761	1380w 230v/50hz	932

**SOPORTES TUBO RECTANGULAR 60X40MM**

DIM (mm)	NEUTRO	PVP(€)	LUZ	CONSUMO/ TENSIÓN	PVP(€)	LUZ Y CALOR	CONSUMO/ TENSIÓN	PVP(€)
520x40x460 - 1GN1/1	IDB34011	247	IDB34111	10w 230v/50hz	604	IDB34211	230w 230v/50hz	696
850x40x460 - 2GN1/1	IDB34021	259	IDB34121	10w 230v/50hz	627	IDB34221	460w 230v/50hz	725
1180x40x460 - 3GN1/1	IDB34031	270	IDB34131	14w 230v/50hz	650	IDB34231	690w 230v/50hz	759
1510x40x460 - 4GN1/1	IDB34041	288	IDB34141	18w 230v/50hz	679	IDB34241	920w 230v/50hz	794
1840x40x460 - 5GN1/1	IDB34051	305	IDB34151	22w 230v/50hz	719	IDB34251	1150w 230v/50hz	863
2170x40x460 - 6GN1/1	IDB34061	334	IDB34161	28w 230v/50hz	811	IDB34261	1380w 230v/50hz	932

**CRISTALES  
TEMPLADOS RECTOS**

- **Crystales superiores** 8mm, para soportes planos o inclinados.
- **Crystales frontales** 8mm para **todo tipo** de pantallas.
- **Fijación** mediante tornillos con junta de goma.

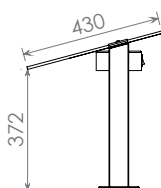

**SUPERIOR**

DIM (mm)	REF	PVP(€)
520x430 - 1GN1/1	IDV34511	133
850x430 - 2GN1/1	IDV34521	145
1180x430 - 3GN1/1	IDV34531	167
1510x430 - 4GN1/1	IDV34541	196
1840x430 - 5GN1/1	IDV34551	236
2170x430 - 6GN1/1	IDV34561	288

**FRONTAL**

ANCHO (mm)	PANTALLA RECTA ALTO 420	PVP(€)	PANTALLA INCLINADA ALTO 340	PVP(€)
520 - 1GN1/1	IDV79611	120	IDV79511	111
850 - 2GN1/1	IDV79621	131	IDV79521	121
1180 - 3GN1/1	IDV79631	149	IDV79531	138
1510 - 4GN1/1	IDV79641	180	IDV79541	167
1840 - 5GN1/1	IDV79651	224	IDV79551	207
2170 - 6GN1/1	IDV79661	255	IDV79561	236

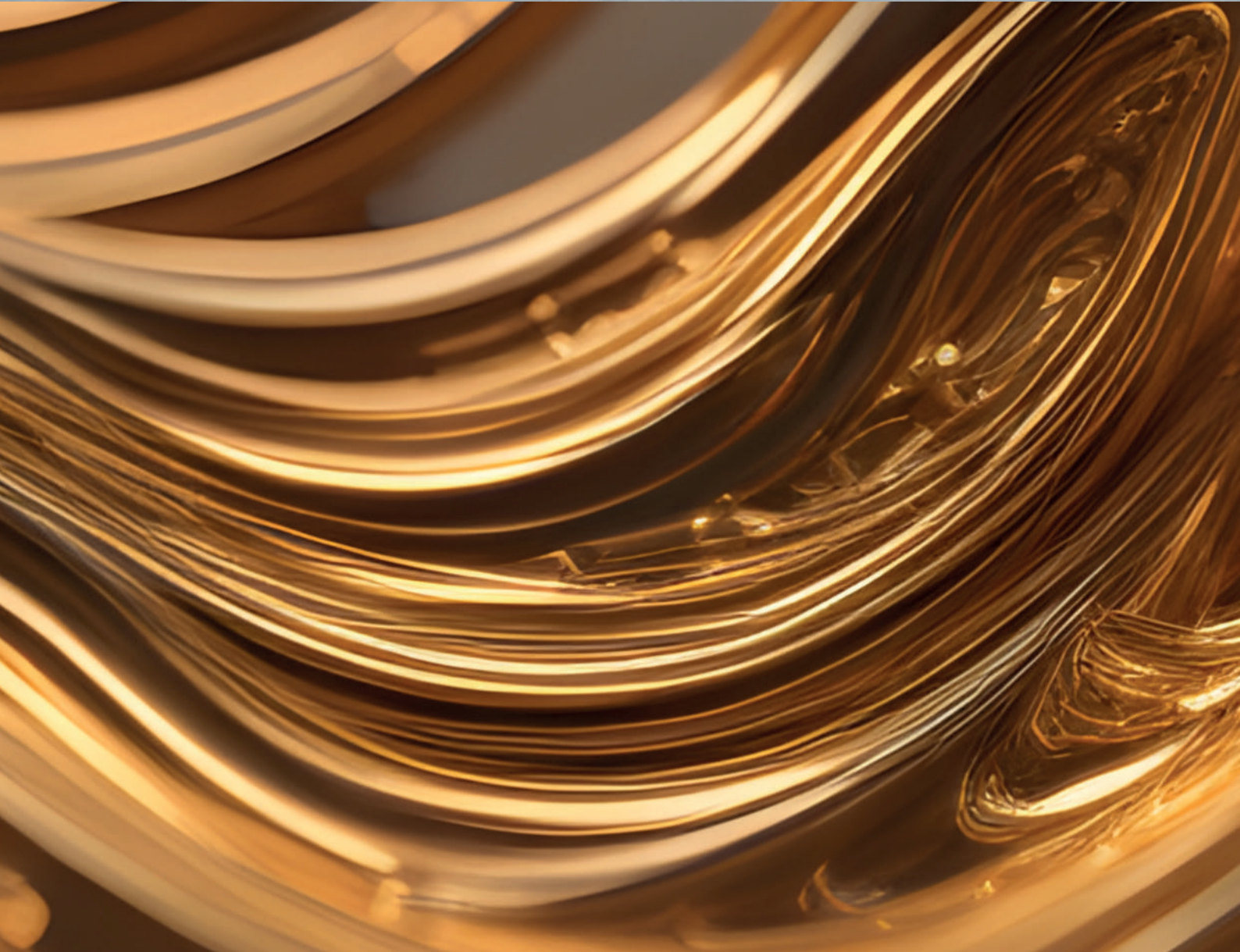





# 15.

- Mesas
- Accesorios mesas
- Estanterías
- Módulos abiertos
- Módulos correderas
- Cafeteros y contra mostradores
- Encimeras
- Muebles abiertos
- Muebles correderas
- Muebles batientes
- Muebles tolva y cajones
- Armarios de pie
- Armarios colgantes
- Complementos encimeras
- Soportes y cartelas
- Accesorios muebles



## MESAS CENTRALES SOLDADAS FLEXI ESTÁNDAR

15.

- **Reforzadas** con omegas.
- **Frontal** soldado de 60mm en punto redondo.
- **Patas** de tubo 40x40 con taco regulable, 6 patas a partir de 2000mm.
- **Altura** limitada a 1000mm.

LARGO (mm)	PVP(€) FONDO HASTA 600	PVP(€) FONDO HASTA 700	PVP(€) FONDO HASTA 850
Hasta 600	489	500	558
De 601 a 800	535	552	615
De 801 a 1000	558	581	661
De 1001 a 1200	592	615	702
De 1201 a 1400	621	650	748
De 1401 a 1600	690	736	822
De 1601 a 1800	719	782	857
De 1801 a 2000	811	840	949
De 2001 a 2200	891	920	1041
De 2201 a 2400	926	960	1081
De 2401 a 2600	960	995	1121
De 2601 a 2800	995	1029	1167
De 2801 a 3000	1047	1087	1231

### MARCO REFUERZO

REF. EID99110



LARGO (mm)	PVP(€) FONDO HASTA 600	PVP(€) FONDO HASTA 700	PVP(€) FONDO HASTA 850
Hasta 600	535	569	621
De 601 a 800	592	627	679
De 801 a 1000	638	661	736
De 1001 a 1200	690	707	794
De 1201 a 1400	725	759	851
De 1401 a 1600	771	805	909
De 1601 a 1800	805	886	966
De 1801 a 2000	891	972	1087
De 2001 a 2200	1064	1110	1190
De 2201 a 2400	1133	1190	1277
De 2401 a 2600	1185	1236	1323
De 2601 a 2800	1225	1282	1369
De 2801 a 3000	1288	1351	1449

### 1 ESTANTE INFERIOR

REF. EID99120



LARGO (mm)	PVP(€) FONDO HASTA 600	PVP(€) FONDO HASTA 700	PVP(€) FONDO HASTA 850
Hasta 600	650	667	725
De 601 a 800	736	771	822
De 801 a 1000	782	811	886
De 1001 a 1200	840	880	966
De 1201 a 1400	903	949	1058
De 1401 a 1600	1018	1070	1173
De 1601 a 1800	1081	1139	1259
De 1801 a 2000	1139	1208	1334
De 2001 a 2200	1242	1317	1415
De 2201 a 2400	1311	1380	1484
De 2401 a 2600	1363	1438	1553
De 2601 a 2800	1415	1501	1610
De 2801 a 3000	1495	1581	1696

### 2 ESTANTES INFERIORES

REF. EID99130



## MESAS MURALES SOLDADAS FLEXI ESTÁNDAR

- **Reforzadas** con omegas.
- **Frontal** soldado de 60mm en punto redondo, **peto** posterior con radio sanitario.
- **Patas** de tubo 40x40 con taco regulable, 6 patas a partir de 2000mm.
- **Altura** limitada a 1000mm.

### MARCO REFUERZO

REF. EID99010



LARGO (mm)	PVP(€) FONDO HASTA 600	PVP(€) FONDO HASTA 700	PVP(€) FONDO HASTA 850
Hasta 600	512	523	564
De 601 a 800	558	575	633
De 801 a 1000	587	610	684
De 1001 a 1200	615	644	725
De 1201 a 1400	650	684	771
De 1401 a 1600	702	759	834
De 1601 a 1800	748	799	880
De 1801 a 2000	851	914	989
De 2001 a 2200	926	995	1075
De 2201 a 2400	960	1035	1116
De 2401 a 2600	989	1070	1156
De 2601 a 2800	1024	1110	1196
De 2801 a 3000	1075	1167	1259

### 1 ESTANTE INFERIOR

REF. EID99020



LARGO (mm)	PVP(€) FONDO HASTA 600	PVP(€) FONDO HASTA 700	PVP(€) FONDO HASTA 850
Hasta 600	575	592	644
De 601 a 800	633	656	713
De 801 a 1000	667	690	776
De 1001 a 1200	725	736	834
De 1201 a 1400	759	788	897
De 1401 a 1600	794	840	955
De 1601 a 1800	845	886	1018
De 1801 a 2000	932	1012	1144
De 2001 a 2200	1110	1185	1254
De 2201 a 2400	1162	1231	1305
De 2401 a 2600	1208	1271	1357
De 2601 a 2800	1259	1317	1409
De 2801 a 3000	1334	1386	1484

### 2 ESTANTES INFERIORES

REF. EID99030



LARGO (mm)	PVP(€) FONDO HASTA 600	PVP(€) FONDO HASTA 700	PVP(€) FONDO HASTA 850
Hasta 600	679	696	753
De 601 a 800	759	788	845
De 801 a 1000	799	828	903
De 1001 a 1200	857	897	983
De 1201 a 1400	920	966	1041
De 1401 a 1600	1029	1087	1185
De 1601 a 1800	1093	1156	1254
De 1801 a 2000	1150	1225	1346
De 2001 a 2200	1277	1363	1478
De 2201 a 2400	1363	1449	1576
De 2401 a 2600	1420	1507	1616
De 2601 a 2800	1478	1570	1691
De 2801 a 3000	1553	1656	1777

## ACCESORIOS MESAS FLEXI ESTÁNDAR

### Plafones para mesa lateral/trasero

- Se suministran totalmente **montados** y soldados.

Plafón lateral a elección del cliente: derecho, izquierdo o intermedio.

CARACTERÍSTICAS	REF	PVP(€)
Plafón lateral	EID90210	161
Plafón trasero	EID90220	161

\* Precio por metro lineal.



### Puertas batientes

- **Puerta batiente** con bisagra vertical pivotante.
- **Largo** máximo 750mm.
- Se suministran totalmente **montadas** y soldadas, con herrajes incluidos.

CARACTERÍSTICAS	REF	PVP(€)
Puerta batiente	EID90300	219
Puerta batiente ventilada	EID90305	283

\* Precio por unidad



### Adaptación de ruedas para mesas

- Se suministran totalmente **montadas** y soldadas a las patas.

Posición de ruedas con freno o sin freno a elección del cliente, izquierda, derecha o frente.

### Ruedas sintéticas

CARACTERÍSTICAS	REF	PVP(€)
4 Ruedas 100Ø (2 con freno)	EID90410	247
6 Ruedas 100Ø (3 con freno)	EID90420	351



### Ruedas acero inoxidable

CARACTERÍSTICAS	REF	PVP(€)
4 Ruedas 100Ø (2 con freno)	EID90430	293
6 Ruedas 100Ø (3 con freno)	EID90440	385



# 15.



## ACCESORIOS MESAS Y MUEBLES FLEXI ESTÁNDAR

- Cajones con guías telescópicas.

Se suministran montados, especificar posición: derecha, izquierda o centro.

### CAJÓN SIMPLE

DIM. MÁXIMAS (mm)	REF	PVP(€)
500x500x220	EID90520	293



### MÓDULO 2 CAJONES

DIM. MÁXIMAS (mm)	REF	PVP(€)
Hasta 500x800x600	EID90550	730
De 501x800x600 a 650x800x600	EID90555	753



### MÓDULO 3 CAJONES

DIM. MÁXIMAS (mm)	REF	PVP(€)
Hasta 500x800x600	EID90560	782
De 501x800x600 a 650x800x600	EID90565	811



### MÓDULO 4 CAJONES

DIM. MÁXIMAS (mm)	REF	PVP(€)
Hasta 500x800x600	EID90570	817
De 501x800x600 a 650x800x600	EID90575	851



### MÓDULO TOLVA

DIM. MÁXIMAS (mm)	REF	PVP(€)
Hasta 500x800x600	EID90580	696
De 501x800x600 a 650x800x600	EID90585	725

## ESTANTERÍAS MURALES FLEXI ESTÁNDAR

15.

- Se suministran totalmente **montadas** y soldadas.
- Cartela central de **refuerzo** a partir de 2000mm.

LARGO (mm)	PVP(€) FONDO HASTA 250	PVP(€) FONDO HASTA 400	PVP(€) FONDO HASTA 500
Hasta 600	132	150	178
De 601 a 800	144	178	213
De 801 a 1000	167	207	242
De 1001 a 1200	178	219	259
De 1201 a 1400	190	236	276
De 1401 a 1600	201	247	293
De 1601 a 1800	219	265	311
De 1801 a 2000	236	293	345
De 2001 a 2200	265	322	380
De 2201 a 2400	316	368	431
De 2401 a 2700	351	403	472
De 2701 a 3000	393	451	543

### ESTANTERÍA MURAL

REF. EID99920

Con dotación de tacos y tornillos  
para su fijación a pared.



## ESTANTERÍAS MURALES DE TUBOS FLEXI ESTÁNDAR

- **Tubos** superiores de Ø30mm tapados con conteras imitación acero.
- Cartela central de **refuerzo** a partir de 2000mm.

LARGO (mm)	PVP(€) FONDO HASTA 450
Hasta 600	219
De 601 a 800	230
De 801 a 1000	259
De 1001 a 1200	282
De 1201 a 1400	305
De 1401 a 1600	328
De 1601 a 1800	345
De 1801 a 2000	357
De 2001 a 2200	385
De 2201 a 2400	420
De 2401 a 2700	460
De 2701 a 3000	515

### ESTANTERÍA MURAL TUBOS

REF. EID99960

Con dotación de tacos y tornillos  
para su fijación a pared.



## ESTANTERÍAS MURALES CESTAS DE LAVADO FLEXI ESTÁNDAR

- Inclinas con **desagüe** inferior.
- Cartela central de **refuerzo** a partir de 2000mm.  
**Indicar lado de desagüe.**

DIM (mm)	PVP(€)
Hasta 600	374
De 601 a 1100	449
De 1101 a 1600	523
De 1601 a 2100	615
De 2101 a 2600	707
De 2601 a 3000	811

### ESTANTERÍA MURAL CESTAS

REF. EID99980

Con dotación de tacos y tornillos  
para su fijación a pared.





# 15.

## SIMPLE

REF. EID99910



## DOBLE

REF. EID99915



## ESTANTERÍAS SOBREMESA FLEXI ESTÁNDAR

- Reforzadas con **omegas** inox, 6 patas a partir de 2100mm.
- **Fondo** limitado a 450mm.
- **Altura** limitado a 800mm.

LARGO (mm)	SIMPLE PVP(€)	DOBLE PVP(€)
Hasta 900	397	541
De 901 a 1100	414	564
De 1101 a 1300	426	581
De 1301 a 1500	443	604
De 1501 a 1700	460	621
De 1701 a 1900	477	644
De 1901 a 2100	500	679
De 2101 a 2300	529	719
De 2301 a 2500	558	748
De 2501 a 2700	581	794
De 2701 a 2900	610	822

## ESTANTERÍAS SOBREMESA CESTAS DE LAVADO

- **Barra** central apoyo cestas de lavado.
- **Desagüe** inferior.

DIM (mm)	PVP(€)
Hasta 600	673
De 601 a 1100	730
De 1101 a 1600	776
De 1601 a 2100	868
De 2101 a 2600	972
De 2601 a 3000	1070

## PEANAS FLEXI ESTÁNDAR

- **Soportes** laterales de sujeción.
- **Marco perimetral** en chapa 2mm.
- **Pata** de tubo 40x40mm con taco regulable hasta 60mm.

DIM (mm)	PVP(€)
Hasta 400x400	265
De 401x401 a 500x500	276
De 501x501 a 600x600	293
De 601x601 a 700x700	334
De 701x701 a 800x800	374
De 801x801 a 900x900	420
De 901x901 a 1000x1000	449

## ESTANTERÍA SOBREMESA CESTAS

REF. EID99945



## PEANA

REF. EID99950



# MÓDULOS NEUTROS FLEXI ESTÁNDAR

# 15.

- **Encimera** no incluida, a elegir mural o central.
- **Patas** cilíndricas 150mm regulables 50mm, 6 patas y **refuerzo** central a partir de 2000mm.
- **Altura** limitada a 950mm.

## ABIERTOS 1 CARA

### ESTANTE BASE

REF. EID99050



LARGO (mm)	PVP(€) FONDO HASTA 600	PVP(€) FONDO HASTA 700	PVP(€) FONDO HASTA 850
Hasta 600	523	541	650
De 601 a 800	581	650	725
De 801 a 1000	650	673	794
De 1001 a 1200	684	719	840
De 1201 a 1400	719	771	897
De 1401 a 1600	782	822	943
De 1601 a 1800	851	891	1064
De 1801 a 2000	932	989	1139
De 2001 a 2200	1018	1081	1242
De 2201 a 2500	1110	1179	1334

### ESTANTE BASE+INTERMEDIO

REF. EID99060



LARGO (mm)	PVP(€) FONDO HASTA 600	PVP(€) FONDO HASTA 700	PVP(€) FONDO HASTA 850
Hasta 600	575	598	702
De 601 a 800	638	667	782
De 801 a 1000	707	736	880
De 1001 a 1200	753	794	937
De 1201 a 1400	811	840	1001
De 1401 a 1600	845	897	1058
De 1601 a 1800	926	989	1162
De 1801 a 2000	1024	1081	1254
De 2001 a 2200	1110	1185	1351
De 2201 a 2500	1208	1300	1420

### ESTANTE BASE

REF. EID99070



LARGO (mm)	PVP(€) FONDO HASTA 600	PVP(€) FONDO HASTA 700	PVP(€) FONDO HASTA 850
Hasta 600	506	518	621
De 601 a 800	564	575	690
De 801 a 1000	621	644	753
De 1001 a 1200	650	679	794
De 1201 a 1400	679	730	851
De 1401 a 1600	759	788	897
De 1601 a 1800	817	857	1012
De 1801 a 2000	920	926	1087
De 2001 a 2200	989	1018	1185
De 2201 a 2500	1064	1087	1271

## ABIERTOS 2 CARAS

### ESTANTE BASE+INTERMEDIO

REF. EID99080



LARGO (mm)	PVP(€) FONDO HASTA 600	PVP(€) FONDO HASTA 700	PVP(€) FONDO HASTA 850
Hasta 600	546	564	673
De 601 a 800	604	627	748
De 801 a 1000	679	702	840
De 1001 a 1200	719	759	897
De 1201 a 1400	776	811	960
De 1401 a 1600	822	863	1018
De 1601 a 1800	909	955	1116
De 1801 a 2000	995	1047	1208
De 2001 a 2200	1087	1144	1300
De 2201 a 2500	1179	1242	1363

## PUERTAS CORREDERAS 1 CARA

LARGO (mm)	PVP(€) FONDO HASTA 600	PVP(€) FONDO HASTA 700	PVP(€) FONDO HASTA 850
Hasta 800	799	874	983
De 801 a 1000	845	920	1035
De 1001 a 1200	891	1081	1213
De 1201 a 1400	960	1139	1265
De 1401 a 1600	1052	1156	1288
De 1601 a 1800	1087	1242	1386
De 1801 a 2000	1213	1305	1461
De 2001 a 2200	1397	1455	1616
De 2201 a 2500	1472	1547	1714

### ESTANTE BASE

REF. EID99053



LARGO (mm)	PVP(€) FONDO HASTA 600	PVP(€) FONDO HASTA 700	PVP(€) FONDO HASTA 850
Hasta 800	828	972	1070
De 801 a 1000	983	1104	1225
De 1001 a 1200	1064	1202	1334
De 1201 a 1400	1167	1254	1392
De 1401 a 1600	1208	1282	1426
De 1601 a 1800	1259	1369	1495
De 1801 a 2000	1323	1449	1599
De 2001 a 2200	1553	1616	1754
De 2201 a 2500	1639	1719	1869

### ESTANTE BASE+INTERMEDIO

REF. EID99063



## PUERTAS CORREDERAS 2 CARAS

LARGO (mm)	PVP(€) FONDO HASTA 600	PVP(€) FONDO HASTA 700	PVP(€) FONDO HASTA 850
Hasta 800	1035	1070	1190
De 801 a 1000	1104	1133	1259
De 1001 a 1200	1185	1219	1351
De 1201 a 1400	1219	1254	1392
De 1401 a 1600	1259	1277	1420
De 1601 a 1800	1311	1346	1495
De 1801 a 2000	1403	1432	1593
De 2001 a 2200	1570	1622	1800
De 2201 a 2500	1639	1702	1892

### ESTANTE BASE

REF. EID99073



### ESTANTE BASE+INTERMEDIO

REF. EID99083

LARGO (mm)	PVP(€) FONDO HASTA 600	PVP(€) FONDO HASTA 700	PVP(€) FONDO HASTA 850
Hasta 800	1098	1127	1248
De 801 a 1000	1156	1185	1311
De 1001 a 1200	1231	1259	1455
De 1201 a 1400	1271	1346	1495
De 1401 a 1600	1317	1397	1553
De 1601 a 1800	1351	1415	1570
De 1801 a 2000	1455	1501	1668
De 2001 a 2200	1558	1599	1777
De 2201 a 2500	1742	1806	2007





## MÓDULOS CAFETEROS FLEXI ESTÁNDAR

- **Encimera** no incluida.
- Trasera abierta para facilitar conexiones, tolva pica marro reforzada, cajones con guías telescópicas, puertas batientes con bisagra pivotante.
- **Patas** cilíndricas 150mm regulables 50mm.
- **Fondo** limitado a 700mm.
- **Altura** limitada a 1100mm.

### MÓDULO COCTELERO

REF. EID99300

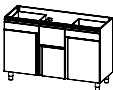
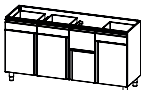
	LARGO (mm)	PVP(€)
	Hasta 500	711
	De 501 a 800	937
	De 801 a 1000	983
	De 1001 a 1200	1024
	De 1201 a 1400	1075
	De 1401 a 1600	1121
	De 1601 a 1800	1317
	De 1801 a 2000	1409

Para otras composiciones consultar.



## MÓDULOS CONTRAMOSTRADORES FLEXI ESTÁNDAR

- **Encimera** no incluida.
- **Estantes** intermedios regulables reforzados con omega central.
- **Patas** cilíndricas 150mm regulables 50mm, 6 patas y refuerzo central a partir de 2000mm.
- **Fondo** limitado a 700mm.
- **Altura** limitada a 1100mm.

### ESTANTE BASE+1 INTERMEDIO

REF. EID99310

LARGO (mm)	PVP(€) FONDO HASTA 450	PVP(€) FONDO HASTA 700
Hasta 600	500	575
De 601 a 800	541	610
De 801 a 1000	575	650
De 1001 a 1200	610	679
De 1201 a 1400	661	719
De 1401 a 1600	696	765
De 1601 a 1800	742	817
De 1801 a 2000	822	914
De 2001 a 2200	863	960
De 2201 a 2500	909	1018



### ESTANTE BASE+2 INTERMEDIOS

REF. EID99320

LARGO (mm)	PVP(€) FONDO HASTA 450	PVP(€) FONDO HASTA 700
Hasta 600	558	638
De 601 a 800	604	679
De 801 a 1000	638	719
De 1001 a 1200	679	753
De 1201 a 1400	736	799
De 1401 a 1600	776	851
De 1601 a 1800	822	909
De 1801 a 2000	903	1012
De 2001 a 2200	949	1064
De 2201 a 2500	995	1116



## ENCIMERAS CENTRALES FLEXI ESTÁNDAR

- Reforzadas con **omegas**.
- **Frontal** soldado en punto redondo.

Preparadas para acoplarse a módulos flexi estándar.

### ENCIMERA CENTRAL

REF. EID99220



LARGO (mm)	PVP(€) FONDO HASTA 600	PVP(€) FONDO HASTA 700	PVP(€) FONDO HASTA 850
Hasta 600	311	368	420
De 601 a 800	322	380	431
De 801 a 1000	339	397	443
De 1001 a 1200	362	420	489
De 1201 a 1400	397	460	512
De 1401 a 1600	426	495	529
De 1601 a 1800	472	535	598
De 1801 a 2000	523	587	656
De 2001 a 2200	552	627	690
De 2201 a 2400	587	661	736
De 2401 a 2600	627	702	765
De 2601 a 2800	684	765	868
De 2801 a 3000	759	845	966

## ENCIMERAS MURALES FLEXI ESTÁNDAR

- Reforzadas con **omegas**.
- **Frontal** soldado en punto redondo, **peto** posterior soldado con radio sanitario.

Preparadas para acoplarse a módulos flexi estándar.

### ENCIMERA MURAL

REF. EID99210



LARGO (mm)	PVP(€) FONDO HASTA 600	PVP(€) FONDO HASTA 700	PVP(€) FONDO HASTA 850
Hasta 600	339	397	449
De 601 a 800	351	414	466
De 801 a 1000	362	426	477
De 1001 a 1200	391	454	489
De 1201 a 1400	426	500	535
De 1401 a 1600	460	523	569
De 1601 a 1800	495	546	604
De 1801 a 2000	552	615	650
De 2001 a 2200	581	656	725
De 2201 a 2400	615	667	776
De 2401 a 2600	656	730	834
De 2601 a 2800	730	811	932
De 2801 a 3000	799	903	1024



NOVEDAD

15.

## MUEBLES NEUTROS CENTRALES FLEXI ESTÁNDAR

- **Encimera** central con radio sanitario reforzada con omegas.
- **Estante** intermedio regulable reforzado con omega central.
- **Patas** cilíndricas 150mm regulables 50mm, 6 patas y **refuerzo** central a partir de 2000mm.
- **Altura** limitada a 950mm.

### ABIERTOS 1 CARA

#### ESTANTE BASE

REF. EID94035



#### ESTANTE BASE+INTERMEDIO

REF. EID94030



### ABIERTOS 2 CARAS

#### ESTANTE BASE

REF. EID94015



#### ESTANTE BASE+INTERMEDIO

REF. EID94010



LARGO (mm)	PVP(€) FONDO HASTA 600	PVP(€) FONDO HASTA 700	PVP(€) FONDO HASTA 850
Hasta 600	923	943	1132
De 601 a 800	963	991	1189
De 801 a 1000	1011	1058	1270
De 1001 a 1200	1072	1120	1321
De 1201 a 1400	1120	1160	1369
De 1401 a 1600	1167	1228	1425
De 1601 a 1800	1242	1303	1511
De 1801 a 2000	1377	1432	1646
De 2001 a 2200	1499	1554	1787
De 2201 a 2500	1622	1676	1911

LARGO (mm)	PVP(€) FONDO HASTA 600	PVP(€) FONDO HASTA 700	PVP(€) FONDO HASTA 850
Hasta 600	1038	1058	1270
De 601 a 800	1079	1106	1327
De 801 a 1000	1126	1181	1417
De 1001 a 1200	1194	1242	1465
De 1201 a 1400	1242	1282	1513
De 1401 a 1600	1289	1350	1566
De 1601 a 1800	1364	1425	1653
De 1801 a 2000	1506	1554	1787
De 2001 a 2200	1628	1683	1935
De 2201 a 2500	1751	1805	2057

LARGO (mm)	PVP(€) FONDO HASTA 600	PVP(€) FONDO HASTA 700	PVP(€) FONDO HASTA 850
Hasta 600	835	896	1075
De 601 a 800	875	923	1107
De 801 a 1000	943	991	1189
De 1001 a 1200	1011	1058	1249
De 1201 a 1400	1052	1092	1289
De 1401 a 1600	1092	1126	1307
De 1601 a 1800	1181	1215	1409
De 1801 a 2000	1262	1310	1506
De 2001 a 2200	1398	1459	1678
De 2201 a 2500	1499	1567	1787

LARGO (mm)	PVP(€) FONDO HASTA 600	PVP(€) FONDO HASTA 700	PVP(€) FONDO HASTA 850
Hasta 600	916	984	1181
De 601 a 800	950	1011	1214
De 801 a 1000	991	1038	1246
De 1001 a 1200	1058	1106	1305
De 1201 a 1400	1127	1181	1394
De 1401 a 1600	1208	1248	1448
De 1601 a 1800	1303	1337	1551
De 1801 a 2000	1384	1438	1654
De 2001 a 2200	1527	1588	1827
De 2201 a 2500	1628	1697	1935

LARGO (mm)	PVP(€) FONDO HASTA 600	PVP(€) FONDO HASTA 700	PVP(€) FONDO HASTA 850
Hasta 800	1303	1364	1637
De 801 a 1000	1371	1438	1726
De 1001 a 1200	1432	1513	1816
De 1201 a 1400	1493	1574	1857
De 1401 a 1600	1554	1635	1930
De 1601 a 1800	1676	1757	2038
De 1801 a 2000	1798	1893	2196
De 2001 a 2200	1968	1981	2278
De 2201 a 2500	2137	2158	2481

LARGO (mm)	PVP(€) FONDO HASTA 600	PVP(€) FONDO HASTA 700	PVP(€) FONDO HASTA 850
Hasta 800	1425	1486	1783
De 801 a 1000	1493	1567	1881
De 1001 a 1200	1561	1642	1970
De 1201 a 1400	1622	1703	2010
De 1401 a 1600	1683	1764	2082
De 1601 a 1800	1805	1893	2196
De 1801 a 2000	1934	2029	2353
De 2001 a 2200	2103	2117	2434
De 2201 a 2500	2280	2300	2645

LARGO (mm)	PVP(€) FONDO HASTA 600	PVP(€) FONDO HASTA 700	PVP(€) FONDO HASTA 850
Hasta 800	1398	1445	1734
De 801 a 1000	1506	1547	1856
De 1001 a 1200	1601	1642	1970
De 1201 a 1400	1689	1737	2050
De 1401 a 1600	1764	1839	2170
De 1601 a 1800	1913	1947	2259
De 1801 a 2000	2022	2036	2361
De 2001 a 2200	2144	2185	2512
De 2201 a 2500	2246	2293	2637

LARGO (mm)	PVP(€) FONDO HASTA 600	PVP(€) FONDO HASTA 700	PVP(€) FONDO HASTA 850
Hasta 800	1513	1561	1873
De 801 a 1000	1622	1669	2003
De 1001 a 1200	1723	1764	2117
De 1201 a 1400	1812	1866	2202
De 1401 a 1600	1886	1968	2322
De 1601 a 1800	2042	2076	2408
De 1801 a 2000	2151	2164	2511
De 2001 a 2200	2273	2314	2661
De 2201 a 2500	2382	2422	2786

## CORREDERAS 1 CARA

### ESTANTE BASE

REF. EID94075



### ESTANTE BASE+INTERMEDIO

REF. EID94070



## CORREDERAS 2 CARAS

### ESTANTE BASE

REF. EID94055



### ESTANTE BASE+INTERMEDIO

REF. EID94050



NOVEDAD

15.

## MUEBLES NEUTROS CENTRALES FLEXI ESTÁNDAR

- **Encimera** central con radio sanitario reforzada con omegas.
- **Estante** intermedio regulable reforzado con omega central.
- **Cajones** con guías telescópicas.
- **Patas** cilíndricas 150mm regulables 50mm.
- **Altura** limitada a 950mm.

### PUERTAS BATIENTES

#### ESTANTE BASE

REF. EID94095



LARGO (mm)	PVP(€) FONDO HASTA 600	PVP(€) FONDO HASTA 700	PVP(€) FONDO HASTA 850
Hasta 600	984	1045	1233
De 601 a 800	1262	13232	1548
De 801 a 1000	1364	1425	1653
De 1001 a 1200	1445	1506	1732

#### ESTANTE BASE+INTERMEDIO

REF. EID94090



LARGO (mm)	PVP(€) FONDO HASTA 600	PVP(€) FONDO HASTA 700	PVP(€) FONDO HASTA 850
Hasta 600	1106	1167	1377
De 601 a 800	1384	1446	1691
De 801 a 1000	1493	1554	1802
De 1001 a 1200	1574	1635	1880

### PUERTAS BATIENTES Y CAJONES

REF. EID94115



LARGO (mm)	PVP(€) FONDO HASTA 600	PVP(€) FONDO HASTA 700	PVP(€) FONDO HASTA 850
Hasta 600	1310	1398	1649
De 601 a 800	1567	1656	1937
De 801 a 1000	1621	1710	1983
De 1001 a 1200	1730	1818	2090

### PUERTAS BATIENTES SIN BASE

REF. EID94130



LARGO (mm)	PVP(€) FONDO HASTA 600	PVP(€) FONDO HASTA 700	PVP(€) FONDO HASTA 850
Hasta 600	1086	1221	1440
De 601 a 800	1398	1527	1787
De 801 a 1000	1500	1628	1889
De 1001 a 1200	1581	1697	1956

LARGO (mm)	PVP(€) FONDO HASTA 600	PVP(€) FONDO HASTA 700	PVP(€) FONDO HASTA 850
Hasta 400	910	964	1137
De 401 a 500	964	1011	1183
De 501 a 600	1187	1235	1432



**TOLVA**  
REF. EID94150

LARGO (mm)	PVP(€) FONDO HASTA 600	PVP(€) FONDO HASTA 700	PVP(€) FONDO HASTA 850
Hasta 400	957	997	1176
De 401 a 500	1018	1058	1238
De 501 a 600	1248	1296	1503



**2 CAJONES**  
REF. EID94170

LARGO (mm)	PVP(€) FONDO HASTA 600	PVP(€) FONDO HASTA 700	PVP(€) FONDO HASTA 850
Hasta 400	984	1018	1201
De 401 a 500	1058	1106	1294
De 501 a 600	1283	1344	1559



**3 CAJONES**  
REF. EID94190

LARGO (mm)	PVP(€) FONDO HASTA 600	PVP(€) FONDO HASTA 700	PVP(€) FONDO HASTA 850
Hasta 400	1120	1154	1361
De 401 a 500	1194	1241	1452
De 501 a 600	1418	1480	1716



**4 CAJONES**  
REF. EID94210

NOVEDAD

15.

## MUEBLES NEUTROS MURALES FLEXI ESTÁNDAR

- **Encimera** mural reforzada con omegas, **peto** trasero soldado con radio sanitario.
- **Estante** intermedio regulable reforzado con omega central.
- **Patas** cilíndricas 150mm regulables 50mm, 6 patas y **refuerzo** central a partir de 2000mm.
- **Altura** limitada a 950mm.

### ESTANTE BASE

REF. EID94025



### ESTANTE BASE+INTERMEDIO

REF. EID94020



### ESTANTE BASE

REF. EID94065



### ESTANTE BASE+INTERMEDIO

REF. EID94060



## ABIERTOS 1 CARA

LARGO (mm)	PVP(€) FONDO HASTA 600	PVP(€) FONDO HASTA 700	PVP(€) FONDO HASTA 850
Hasta 600	997	1018	1221
De 601 a 800	1038	1065	1278
De 801 a 1000	1086	1133	1360
De 1001 a 1200	1147	1194	1409
De 1201 a 1400	1194	1235	1457
De 1401 a 1600	1242	1303	1511
De 1601 a 1800	1316	1377	1598
De 1801 a 2000	1452	1506	1732
De 2001 a 2200	1574	1628	1873
De 2201 a 2500	1696	1751	2013

LARGO (mm)	PVP(€) FONDO HASTA 600	PVP(€) FONDO HASTA 700	PVP(€) FONDO HASTA 850
Hasta 600	1113	1133	1360
De 601 a 800	1153	1181	1417
De 801 a 1000	1201	1255	1506
De 1001 a 1200	1269	1316	1553
De 1201 a 1400	1316	1357	1601
De 1401 a 1600	1364	1425	1653
De 1601 a 1800	1438	1499	1739
De 1801 a 2000	1581	1628	1873
De 2001 a 2200	1703	1757	2021
De 2201 a 2500	1825	1879	2143

## PUERTAS CORREDERAS

LARGO (mm)	PVP(€) FONDO HASTA 600	PVP(€) FONDO HASTA 700	PVP(€) FONDO HASTA 850
Hasta 800	1377	1438	1726
De 801 a 1000	1445	1513	1816
De 1001 a 1200	1506	1588	1905
De 1201 a 1400	1567	1649	1946
De 1401 a 1600	1628	1710	2018
De 1601 a 1800	1751	1832	2125
De 1801 a 2000	1873	1968	2282
De 2001 a 2200	2042	2056	2364
De 2201 a 2500	2212	2232	2567

LARGO (mm)	PVP(€) FONDO HASTA 600	PVP(€) FONDO HASTA 700	PVP(€) FONDO HASTA 850
Hasta 800	1499	1561	1873
De 801 a 1000	1567	1642	1970
De 1001 a 1200	1635	1717	2060
De 1201 a 1400	1696	1778	2098
De 1401 a 1600	1757	1839	2170
De 1601 a 1800	1879	1968	2282
De 1801 a 2000	2008	2103	2440
De 2001 a 2200	2178	2192	2520
De 2201 a 2500	2354	2375	2731



## PUERTAS BATIENTES

## ESTANTE BASE

REF. EID94085

LARGO (mm)	PVP(€) FONDO HASTA 600	PVP(€) FONDO HASTA 700	PVP(€) FONDO HASTA 850
Hasta 600	1038	1099	1296
De 601 a 800	1316	1377	1611
De 801 a 1000	1418	1479	1716
De 1001 a 1200	1499	1561	1796



## ESTANTE BASE+INTERMEDIO

REF. EID94080

LARGO (mm)	PVP(€) FONDO HASTA 600	PVP(€) FONDO HASTA 700	PVP(€) FONDO HASTA 850
Hasta 600	1160	1221	1440
De 601 a 800	1438	1500	1755
De 801 a 1000	1547	1608	1865
De 1001 a 1200	1628	1690	1943

PUERTAS BATIENTES  
Y CAJONES

## PUERTAS BAT. Y CAJONES

REF. EID94105

LARGO (mm)	PVP(€) FONDO HASTA 600	PVP(€) FONDO HASTA 700	PVP(€) FONDO HASTA 850
Hasta 600	1364	1453	1714
De 601 a 800	1621	1710	2001
De 801 a 1000	1676	1764	2046
De 1001 a 1200	1784	1873	2154

PUERTAS BATIENTES  
SIN BASE

## PUERTAS BAT. SIN BASE

REF. EID94120

LARGO (mm)	PVP(€) FONDO HASTA 600	PVP(€) FONDO HASTA 700	PVP(€) FONDO HASTA 850
Hasta 600	1133	1256	1482
De 601 a 800	1453	1601	1873
De 801 a 1000	1554	1697	1958
De 1001 a 1200	1635	1778	2044



NOVEDAD

## MUEBLES MURALES CAJONES FLEXI ESTÁNDAR

- **Encimera** central con radio sanitario reforzada con omegas.
- **Estante** intermedio regulable reforzado con omega central.
- **Cajones** con guías telescópicas.
- **Patas** cilíndricas 150mm regulables 50mm.
- **Altura** limitada a 950mm.

LARGO (mm)	PVP(€) FONDO HASTA 600	PVP(€) FONDO HASTA 700	PVP(€) FONDO HASTA 850
Hasta 400	984	1024	1198
De 401 a 500	1038	1086	1259
De 501 a 600	1263	1310	1507



**TOLVA**  
REF. EID94140

LARGO (mm)	PVP(€) FONDO HASTA 600	PVP(€) FONDO HASTA 700	PVP(€) FONDO HASTA 850
Hasta 400	1031	1073	1255
De 401 a 500	1093	1133	1314
De 501 a 600	1323	1371	1577



**2 CAJONES**  
REF. EID94160

LARGO (mm)	PVP(€) FONDO HASTA 600	PVP(€) FONDO HASTA 700	PVP(€) FONDO HASTA 850
Hasta 400	1058	1093	1279
De 401 a 500	1133	1181	1370
De 501 a 600	1357	1418	1631



**3 CAJONES**  
REF. EID94180

LARGO (mm)	PVP(€) FONDO HASTA 600	PVP(€) FONDO HASTA 700	PVP(€) FONDO HASTA 850
Hasta 400	1194	1228	1477
De 401 a 500	1269	1317	1528
De 501 a 600	1493	1554	1787



**4 CAJONES**  
REF. EID94200

## MUEBLES CAFETEROS FLEXI ESTÁNDAR



\*modelo mural

- **Encimera** mural ocentral, agujero pasacables  $\varnothing$ 52mm.
- Trasera abierta para facilitar conexiones, tolva pica marro reforzada, cajones con guías telescópicas, puertas batientes con bisagra pivotante.
- **Patas** cilíndricas 150mm regulables 50mm.
- **Fondo** limitado a 700mm.
- **Altura** limitada a 1100mm.

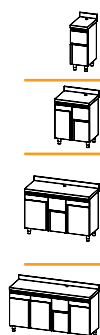

LARGO (mm)	MURAL PVP(€)	CENTRAL PVP(€)
Hasta 500	892	856
De 501 a 800	1051	1009
De 801 a 1000	1156	1110
De 1001 a 1200	1275	1230
De 1201 a 1400	1458	1407
De 1401 a 1600	1640	1583
De 1601 a 1800	1836	1781
De 1801 a 2000	2020	1959

REF. EID94220

REF. EID94230

## MUEBLES CONTRAMOSTRADORES FLEXI ESTÁNDAR

- **Encimera** reforzada con omegas. **peto** trasero soldado con radio sanitario.
- **Estantes** intermedios regulables reforzados con omega central.
- **Patas** cilíndricas 150mm regulables 50mm, 6 patas y **refuerzo** central a partir de 2000mm.
- **Fondo** limitado a 700mm.
- **Altura** limitada a 1100mm.

### ESTANTE BASE+1 INTERMEDIO



LARGO (mm)	MURAL		CENTRAL	
	PVP(€) FONDO HASTA 450	PVP(€) FONDO HASTA 700	PVP(€) FONDO HASTA 450	PVP(€) FONDO HASTA 700
Hasta 600	592	773	565	738
De 601 a 800	624	814	596	777
De 801 a 1000	686	855	655	817
De 1001 a 1200	787	936	752	894
De 1201 a 1400	837	991	799	946
De 1401 a 1600	888	1046	848	999
De 1601 a 1800	967	1137	923	1086
De 1801 a 2000	1045	1228	998	1173
De 2001 a 2200	1170	1375	1117	1313
De 2201 a 2500	1311	1540	1252	1471

REF. EID94240

REF. EID94250

### ESTANTE BASE+2 INTERMEDIOS



LARGO (mm)	MURAL		CENTRAL	
	PVP(€) FONDO HASTA 450	PVP(€) FONDO HASTA 700	PVP(€) FONDO HASTA 450	PVP(€) FONDO HASTA 700
Hasta 600	654	851	625	813
De 601 a 800	689	896	658	856
De 801 a 1000	753	942	719	900
De 1001 a 1200	861	1031	822	985
De 1201 a 1400	919	1089	878	1040
De 1401 a 1600	977	1146	933	1094
De 1601 a 1800	1062	1248	1014	1192
De 1801 a 2000	1147	1350	1095	1289
De 2001 a 2200	1284	1511	1226	1443
De 2201 a 2500	1439	1694	1374	1618

REF. EID94260

REF. EID94270

## ARMARIOS DE PIE FLEXI ESTÁNDAR

- Estante base con doble omega de **refuerzo**. 3 estantes intermedios regulables y reforzados con **omegas** inox.
- Puertas **correderas** con rodamiento superior de nylon, puertas **batientes** con bisagra pivotante desmontable.
- **Patas** cilíndricas 150mm regulables 50mm, 6 patas y **refuerzo** central a partir de 1400mm.
- **Altura** limitada a 2000mm.

## ARMARIOS ABIERTOS

REF. EID99500



LARGO (mm)	PVP(€) FONDO HASTA 600	PVP(€) FONDO HASTA 700
Hasta 600	1035	1127
De 601 a 800	1116	1208
De 801 a 1000	1219	1294
De 1001 a 1200	1334	1415
De 1201 a 1400	1438	1530
De 1401 a 1600	1564	1714

## ARMARIOS BATIENTES

REF. EID99510



LARGO (mm)	PVP(€) FONDO HASTA 600	PVP(€) FONDO HASTA 700
Hasta 600	1271	1363
De 601 a 800	1518	1633
De 801 a 1000	1771	1869
De 1001 a 1200	1990	2105
De 1201 a 1400	2185	2306
De 1401 a 1600	2455	2582

## ARMARIOS CORREDERAS

REF. EID99520



LARGO (mm)	PVP(€) FONDO HASTA 600	PVP(€) FONDO HASTA 700
Hasta 1000	2047	2156
De 1001 a 1200	2179	2294
De 1201 a 1400	2363	2490
De 1401 a 1600	2645	2783
De 1601 a 1800	2979	3134
De 1801 a 2000	3209	3375

## ARMARIOS COLGANTES FLEXI ESTÁNDAR

- Estante base con doble omega de **refuerzo**. Estante intermedio regulable y reforzado con **omega** inox.
- Puertas **correderas** con rodamiento superior de nylon.
- **Refuerzo** central a partir de 1400mm.
- **Altura** limitada a 700mm.
- **Fondo** limitado a 500mm.

### ARMARIOS ABIERTOS

REF. EID99610



LARGO (mm)	PVP(€)
Hasta 600	518
De 601 a 800	558
De 801 a 1000	610
De 1001 a 1200	667
De 1201 a 1400	719
De 1401 a 1600	776
De 1601 a 1800	828
De 1801 a 2000	886

### ARMARIOS CORREDERAS

REF. EID99620



LARGO (mm)	PVP(€)
Hasta 1000	811
De 1001 a 1200	874
De 1201 a 1400	920
De 1401 a 1600	1110
De 1601 a 1800	1144
De 1801 a 2000	1282

### ARMARIOS CORREDERAS CON ESCURRIDOR

REF. EID99630



LARGO (mm)	PVP(€)
Hasta 1000	909
De 1001 a 1200	966
De 1201 a 1400	1058
De 1401 a 1600	1144



## COMPLEMENTOS ENCIMERA FLEXI ESTÁNDAR

CARACTERÍSTICAS	REF	PVP(€)
Chaflán en encimera	EID90100	144
Peto lateral radio sanitario inferior	EID90101	144
Peto alto 150mm (limitado a fondo 800mm máx.)	EID90102	46 €/m
Aro de desbarace de goma diámetro 200mm	EID90110	127
Perfil salvaaguas perimetral tipo roldana	EID90120	52 €/m



## SOPORTES Y CARTELAS FLEXI ESTÁNDAR

Se suministran con todo lo necesario para su montaje.

CARACTERÍSTICAS	REF	PVP(€)
Soporte con pata para encimera especial	EID90610	167
Soporte central para encimera especial	EID90620	144
Cartela de sujeción de chapa de 1,5 mm	EID90630	69





## ADAPTACIÓN CERRADURA

- Adaptadas a las **puertas** y **cajones** de la gama flexi estándar.

	REF	PVP(€)
Adaptación cerradura con llave	EID90520	<b>86</b>

**Precio por unidad.**

## ZÓCALOS PARA MESAS/MÓDULOS/ARMARIOS

- Fácil montaje sin herramientas, en la parte inferior del mueble.

	REF	PVP(€)
Zócalo inferior	EID90400	<b>81</b>

**Precio por metro lineal.**

## PUERTAS BATIENTES/CORREDERAS PARA MUEBLES NEUTROS

- **Puertas correderas** con rodamiento superior de nylon.
- Puertas batientes con bisagra vertical pivotante.
- **Largo** máximo 750mm en puerta batiente y 1500mm en puerta corredera.

CARACTERÍSTICAS	REF	PVP(€)
Puerta corredera	EID90320	<b>219</b>
Puerta corredera ventilada	EID90325	<b>282</b>

**Precio por metro lineal.**

CARACTERÍSTICAS	REF	PVP(€)
Puerta batiente	EID90310	<b>362</b>
Puerta batiente ventilada	EID90315	<b>403</b>

**Precio por unidad.**

## ADAPTACIÓN DE RUEDAS A MÓDULOS/ARMARIOS

**Posición ruedas con freno o sin freno a elección del cliente: izquierda, derecha o frente.**

RUEDAS SINTÉTICAS	REF	PVP(€)
4 Ruedas 125ø (2 con freno)	EID90415	<b>276</b>
6 Ruedas 125ø (3 con freno)	EID90425	<b>374</b>

RUEDAS ACERO INOXIDABLE	REF	PVP(€)
4 Ruedas 125ø (2 con freno)	EID90435	<b>328</b>
6 Ruedas 125ø (3 con freno)	EID90445	<b>420</b>

## Condiciones generales de venta

### Aceptación de condiciones

La aceptación de estas condiciones queda implícita al realizar cualquier pedido.

Ideacer Inox S.L. se reserva el derecho a realizar modificaciones en el contenido de este catálogo sin previo aviso.

### Precios

Los precios indicados en la tarifa son precios venta al público recomendados, sin incluir el IVA (P.V.P.). IdeAcer se reserva el derecho a modificar los precios recogidos en este catálogo, notificando previamente a las partes involucradas

En ningún caso, los precios incluyen la instalación y puesta en marcha de los productos adquiridos.

La facturación se llevará a cabo de acuerdo con los precios vigentes en el momento de la expedición.

### Transporte a Península, Baleares y Canarias

La entrega de la mercancía se realizará mediante los medios más apropiados para cada artículo o pedido. En casos que requieran embalajes especiales, Ideacer evaluará el coste correspondiente, el cual se reflejará en la factura.

Los portes serán pagados a partir de un total de 500€ en productos estándar, flexi estándar y medida. En pedidos inferiores a este importe, se facturará el coste del transporte.

En caso de averías o daños durante el transporte, se debe presentar una reclamación de manera **inmediata** en el momento de la descarga, anotando en el albarán los daños detectados. De lo contrario, la compañía de transporte no acepta dichas reclamaciones e Ideacer no puede tramitar la garantía que corresponda.

### Cancelación de pedido

No se aceptará ninguna cancelación de pedido en los siguientes casos:

- Si la expedición del material se ha llevado a cabo antes de recibir la orden de anulación del pedido.
- Para productos flexi estándar o a medida que ya hayan iniciado su proceso de fabricación.

En estos supuestos el cliente será responsable de los costes generados hasta el momento de la cancelación.

### Devoluciones

No se admitirán devoluciones de productos que hayan sido modificados, utilizados o que carezcan de la protección plástica original del acero. Asimismo, solo se aceptarán devoluciones autorizadas por IdeAcer.

Los gastos de transporte y otros costes relacionados con la devolución serán responsabilidad del cliente.

### Garantía

La garantía tiene una vigencia de 1 año y cubre exclusivamente el cambio de artículos y piezas defectuosas desde la fecha de expedición.

En casos de artículos en garantía, los repuestos se enviarán con portes pagados, mientras que en casos de artículos fuera de garantía, los portes correrán a cargo del destinatario.

Los desplazamientos y servicios de mano de obra serán responsabilidad del comprador en todas las circunstancias.

La garantía no cubre la mala instalación, utilización inapropiada o el uso indebido de nuestros productos.

### Jurisdicción

En caso de litigio, el Tribunal de Lleida será el único competente para su resolución.

